

Ambassador
MARINE

FORMERLY BRANDED AS
SHURflo

...products built for the elements.™



**MARINE GRADE
FAUCETS & SINKS**

Faucets • Showers • Sprayers • Accessories
Stainless Steel & Vessel Sinks • Drains

'25

CONVENIENCE COMFORT & QUALITY MARINE GRADE

This is what your boating experience is all about. Ambassador Marine products offer the Convenience and Comfort you're accustomed to at home, with the added Quality necessary to withstand the harsh marine environment.

Designed specifically for the marine customer, Ambassador Marine faucets, showers, sprayers and accessories carry added features such as stainless steel hardware, extended nickel-plating and state-of-the-art chroming process, ensuring long lasting quality and satisfaction.

Ambassador Marine stainless steel, porcelain & glass vessel sinks and unique drain designs incorporate elements specifically with today's discerning boater in mind. Simple touches like our exclusive SoundKOTE –

Noise Reduction Technology, versatile installation options, heavy gauge passivated 304 stainless steel, tempered glass, real porcelain and coordinated marine-application specific drains will deliver on the "at home" feeling, while on the water.

Offering an array of designs, styles and finishes, Ambassador Marine can satisfy all your faucet and sink needs from the transom shower to the galley. Ambassador Marine products are truly **...products built for the elements.™**



ambassadormarine.com



INFORMATION

- Products
- Where To Buy
- Sales Contacts
- Product Support
- Catalogs
- Our Story
- Gerber Partnership
- Events & News
- Links

PRODUCT DETAILS

- Available Finishes
- Stock Status
- Spec Drawings
- Installation Hole Size(s)
- Plumbing Connection(s)
- Drain Hole Size
- Sink Flange Style
- Installation Instructions
- Parts Lists
- Warranty
- Related Products
- Certifications & Compliances
- Packaging Styles
- Additional Images
- 3D Renderings

SUPPLIER of the YEAR



On March 5, 2024, out of nearly 90 Preferred Suppliers to the Independent Boat Builders, Inc., Ambassador Marine was again awarded **Supplier of the Year**, for the second year in a row!

We are extremely proud to continue to be recognized by the group of member-builders with their highest honor for our dedication to quality, service and support.

2023 - 1st Place

2024 - 2nd Place

IBBI is a buying cooperative, currently made up of 15 independent boat builders, manufacturing 34 boat brands.



A BREATH OF INSPIRATION

Working within a space, and elevating it.
Blending high style with pure performance.
Delivering innovative, bold, beautiful solutions.
Always in tune with the surroundings.
A touch of grace. A modern line.
Meticulously engineered.
Thoughtfully designed.
This is **Gerber**.

AMBASSADOR MARINE is proud to be the exclusive marketing partner to the marine industry of the complete line of over 3,000

GERBER[®]

Est. 1932

formerly branded as **danze**[®]
faucets, showerheads, sinks, toilets,
accessories and more...



Contact your
Ambassador Marine
sales representative for details and
exclusive Marine Industry trade pricing

GERBER
D221144BN

TRANSOM SHOWERS HOT/COLD

MARINE GRADE



Transom Shower

AIDACK™ / SMALL SPRAYER SERIES

Stainless Steel Lid	OEM #	Aftermarket #	Cup & Lid	Sprayer Finish	Hose Length	Hose Type
• Solid cast 316 stainless steel lid with UV protected heavy duty ABS plastic cup	136-1740-AW	--	Arctic White & Stainless Steel	Arctic White	6' (1.8m)	White Rubber
• Integrated Aidack™ Control Valve (Hot/Cold)	136-1747-AW	--	Arctic White & Stainless Steel	Arctic White	10' (3m)	White Rubber
• Heavy duty, UV protected, ABS plastic sprayer	136-1748-AW	--	Arctic White & Stainless Steel	Arctic White	6' (1.8m)	Stainless Steel
• Complete water shut-off when trigger is not engaged	136-1740-WH	--	Warm White & Stainless Steel	Warm White	6' (1.8m)	White Rubber
• Depressing trigger allows for intermittent water flow – lifting trigger locks it on for continuous water flow	136-1747-WH	--	Warm White & Stainless Steel	Warm White	10' (3m)	White Rubber
• Vertical wall-mount, horizontal wall-mount (lid opening up or down) or deck-mount	136-1748-WH	--	Warm White & Stainless Steel	Warm White	6' (1.8m)	Stainless Steel
• Stainless steel lid with gasket forms a tight seal when lid is closed to prevent water from penetrating (NOTE: not guaranteed to be water-tight)	136-1740-CP	--	Chrome & Stainless Steel	Chrome	6' (1.8m)	Black Rubber
• Heavy duty pull-out hose	136-1740-CW	--	Chrome & Stainless Steel	Chrome	6' (1.8m)	White Rubber
• All brass valve body with metal handle	136-1747-CW	--	Chrome & Stainless Steel	Chrome	10' (3m)	White Rubber
• Ceramic disc valve	136-1748-CW	--	Chrome & Stainless Steel	Chrome	6' (1.8m)	Stainless Steel
• Flexible stainless steel braided supply line hoses	136-1740-KP	--	Black & Stainless Steel	Black	6' (1.8m)	Black Rubber
• Stainless steel mounting screws	136-1748-KP	--	Black & Stainless Steel	Black	6' (1.8m)	Stainless Steel
• Two hole mount, 3" Ø (2 1/2" - 2 5/8" CC)						
• Connections: 1/2" NPS-M						

Bulkhead Sprayer Holders

sold separately (see page 39)



Transom Shower

AIDACK™ / HAMMER-HEAD SPRAYER SERIES

Stainless Steel Lid	OEM #	Aftermarket #	Cup & Lid	Sprayer Finish	Hose Length	Hose Type
• Solid cast 316 stainless steel lid with UV protected heavy duty ABS plastic cup	136-1742-AW	--	Arctic White & Stainless Steel	Arctic White & Chrome	6' (1.8m)	White Rubber
• Integrated Aidack™ Control Valve (Hot/Cold)	136-1744-AW	--	Arctic White & Stainless Steel	Arctic White & Chrome	10' (3m)	White Rubber
• Heavy duty, UV protected, ABS plastic and chrome plated brass sprayer	136-1743-AW	--	Arctic White & Stainless Steel	Arctic White & Chrome	6' (1.8m)	Stainless Steel
• Complete water shut-off when trigger is not engaged	136-1742-WH	--	Warm White & Stainless Steel	Warm White & Chrome	6' (1.8m)	White Rubber
• Depressing trigger allows for intermittent water flow – lifting trigger locks it on for continuous water flow	136-1744-WH	--	Warm White & Stainless Steel	Warm White & Chrome	10' (3m)	White Rubber
• Vertical wall-mount, horizontal wall-mount (lid opening up or down) or deck-mount	136-1743-WH	--	Warm White & Stainless Steel	Warm White & Chrome	6' (1.8m)	Stainless Steel
• Stainless steel lid with gasket forms a tight seal when lid is closed to prevent water from penetrating (NOTE: not guaranteed to be water-tight)	136-1742-CA	--	Chrome & Stainless Steel	Arctic White & Chrome	6' (1.8m)	White Rubber
• Heavy duty pull-out hose	136-1744-CA	--	Chrome & Stainless Steel	Arctic White & Chrome	10' (3m)	White Rubber
• All brass valve body with metal handle	136-1743-CA	--	Chrome & Stainless Steel	Arctic White & Chrome	6' (1.8m)	Stainless Steel
• Ceramic disc valve	136-1742-CW	--	Chrome & Stainless Steel	Warm White & Chrome	6' (1.8m)	White Rubber
• Flexible stainless steel braided supply line hoses	136-1744-CW	--	Chrome & Stainless Steel	Warm White & Chrome	10' (3m)	White Rubber
• Stainless steel mounting screws	136-1743-CW	--	Chrome & Stainless Steel	Warm White & Chrome	6' (1.8m)	Stainless Steel
• Two hole mount, 3" Ø (2 1/2" - 2 5/8" CC)	136-1742-CP	--	Chrome & Stainless Steel	Black & Chrome	6' (1.8m)	Black Rubber
• Connections: 1/2" NPS-M	136-1743-CP	--	Chrome & Stainless Steel	Black & Chrome	6' (1.8m)	Stainless Steel
	136-1742-KP	--	Black & Stainless Steel	Black & Chrome	6' (1.8m)	Black Rubber
	136-1743-KP	--	Black & Stainless Steel	Black & Chrome	6' (1.8m)	Stainless Steel

OEM # – Not Labeled Or Packaged For Resale Aftermarket # – Labeled And Packaged For Resale NOTE: Dimension Drawings ±1/16" (for reference only – may not be to scale)

MARINE GRADE

ONLY COLD TRANSOM SHOWERS



Transom Shower

TRINIDAD™ / SMALL SPRAYER SERIES

Stainless Steel Lid	OEM #	Aftermarket #	Cup & Lid	Sprayer Finish	Hose Length	Hose Type
• Solid cast 316 stainless steel lid with UV protected heavy duty ABS plastic cup	136-0240-AW	--	Arctic White & Stainless Steel	Arctic White	6' (1.8m)	White Rubber
• Integrated Trinidad™ Control Valve (Cold Only)	136-0247-AW	--	Arctic White & Stainless Steel	Arctic White	10' (3m)	White Rubber
• Heavy duty, UV protected, ABS plastic sprayer	136-0248-AW	--	Arctic White & Stainless Steel	Arctic White	6' (1.8m)	Stainless Steel
• Complete water shut-off when trigger is not engaged	136-0240-WH	--	Warm White & Stainless Steel	Warm White	6' (1.8m)	White Rubber
• Depressing trigger allows for intermittent water flow – lifting trigger locks it on for continuous water flow	136-0247-WH	--	Warm White & Stainless Steel	Warm White	10' (3m)	White Rubber
• Vertical wall-mount, horizontal wall-mount (lid opening up or down) or deck-mount	136-0248-WH	--	Warm White & Stainless Steel	Warm White	6' (1.8m)	Stainless Steel
• Stainless steel lid with gasket forms a tight seal when lid is closed to prevent water from penetrating (NOTE: not guaranteed to be water-tight)	136-0240-CP	--	Chrome & Stainless Steel	Chrome	6' (1.8m)	Black Rubber
• Heavy duty pull-out hose	136-0240-CW	--	Chrome & Stainless Steel	Chrome	6' (1.8m)	White Rubber
• All brass valve body with metal handle	136-0247-CW	--	Chrome & Stainless Steel	Chrome	10' (3m)	White Rubber
• Ceramic disc valve	136-0248-CW	--	Chrome & Stainless Steel	Chrome	6' (1.8m)	Stainless Steel
• Flexible stainless steel braided supply line hoses	136-0240-KP	--	Black & Stainless Steel	Black	6' (1.8m)	Black Rubber
• Stainless steel mounting screws	136-0248-KP	--	Black & Stainless Steel	Black	6' (1.8m)	Stainless Steel
• Two hole mount, 3" Ø (2 1/2" - 2 5/8" CC)						
• Connections: 1/2" NPS-M						

Bulkhead Sprayer Holders

sold separately (see page 39)



Transom Shower

TRINIDAD™ / HAMMER-HEAD SPRAYER SERIES

Stainless Steel Lid	OEM #	Aftermarket #	Cup & Lid	Sprayer Finish	Hose Length	Hose Type
• Solid cast 316 stainless steel lid with UV protected heavy duty ABS plastic cup	136-0242-AW	--	Arctic White & Stainless Steel	Arctic White & Chrome	6' (1.8m)	White Rubber
• Integrated Trinidad™ Control Valve (Cold Only)	136-0244-AW	--	Arctic White & Stainless Steel	Arctic White & Chrome	10' (3m)	White Rubber
• Heavy duty, UV protected, ABS plastic and chrome plated brass sprayer	136-0243-AW	--	Arctic White & Stainless Steel	Arctic White & Chrome	6' (1.8m)	Stainless Steel
• Complete water shut-off when trigger is not engaged	136-0242-WH	--	Warm White & Stainless Steel	Warm White & Chrome	6' (1.8m)	White Rubber
• Depressing trigger allows for intermittent water flow – lifting trigger locks it on for continuous water flow	136-0244-WH	--	Warm White & Stainless Steel	Warm White & Chrome	10' (3m)	White Rubber
• Vertical wall-mount, horizontal wall-mount (lid opening up or down) or deck-mount	136-0243-WH	--	Warm White & Stainless Steel	Warm White & Chrome	6' (1.8m)	Stainless Steel
• Stainless steel lid with gasket forms a tight seal when lid is closed to prevent water from penetrating (NOTE: not guaranteed to be water-tight)	136-0242-CA	--	Chrome & Stainless Steel	Arctic White & Chrome	6' (1.8m)	White Rubber
• Heavy duty pull-out hose	136-0244-CA	--	Chrome & Stainless Steel	Arctic White & Chrome	10' (3m)	White Rubber
• All brass valve body with metal handle	136-0243-CA	--	Chrome & Stainless Steel	Arctic White & Chrome	6' (1.8m)	Stainless Steel
• Ceramic disc valve	136-0242-CW	--	Chrome & Stainless Steel	Warm White & Chrome	6' (1.8m)	White Rubber
• Flexible stainless steel braided supply line hoses	136-0244-CW	--	Chrome & Stainless Steel	Warm White & Chrome	10' (3m)	White Rubber
• Stainless steel mounting screws	136-0243-CW	--	Chrome & Stainless Steel	Warm White & Chrome	6' (1.8m)	Stainless Steel
• Two hole mount, 3" Ø (2 1/2" - 2 5/8" CC)	136-0242-CP	--	Chrome & Stainless Steel	Black & Chrome	6' (1.8m)	Black Rubber
• Connections: 1/2" NPS-M	136-0243-CP	--	Chrome & Stainless Steel	Black & Chrome	6' (1.8m)	Stainless Steel
	136-0242-KP	--	Black & Stainless Steel	Black & Chrome	6' (1.8m)	Black Rubber
	136-0243-KP	--	Black & Stainless Steel	Black & Chrome	6' (1.8m)	Stainless Steel

OEM # – Not Labeled Or Packaged For Resale Aftermarket # – Labeled And Packaged For Resale NOTE: Dimension Drawings ±1/16" (for reference only – may not be to scale)

TRANSOM SHOWERS HOT/COLD MARINE GRADE

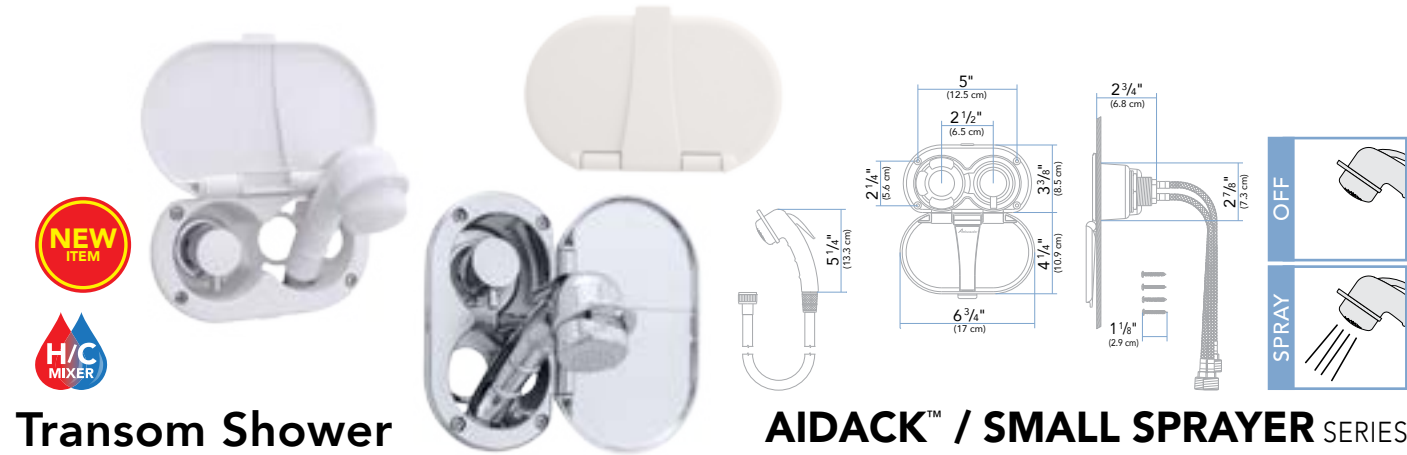

Transom Shower

Plastic Lid

- UV protected heavy duty ABS plastic lid and cup
- Integrated Aidack™ Control Valve (Hot/Cold)
- Heavy duty, UV protected, ABS plastic sprayer
- Complete water shut-off when trigger is not engaged
- Depressing trigger allows for intermittent water flow – lifting trigger locks it on for continuous water flow
- Vertical wall-mount, horizontal wall-mount (lid opening up or down) or deck-mount
- Heavy duty pull-out hose
- All brass valve body with metal handle
- Ceramic disc valve
- Flexible stainless steel braided supply line hoses
- Stainless steel mounting screws
- Two hole mount, 3" Ø (2 1/2" - 2 5/8" CC)
- Connections: 1/2" NPS-M

OEM #	Aftermarket #	Cup & Lid	Sprayer Finish	Hose Length	Hose Type
136-1700-AW	--	Arctic White	Arctic White	6' (1.8m)	White Rubber
136-1707-AW	--	Arctic White	Arctic White	10' (3m)	White Rubber
136-1708-AW	--	Arctic White	Arctic White	6' (1.8m)	Stainless Steel
136-1700-WH	--	Warm White	Warm White	6' (1.8m)	White Rubber
136-1707-WH	--	Warm White	Warm White	10' (3m)	White Rubber
136-1708-WH	--	Warm White	Warm White	6' (1.8m)	Stainless Steel
136-1700-CP	--	Chrome	Chrome	6' (1.8m)	Black Rubber
136-1700-CW	--	Chrome	Chrome	6' (1.8m)	White Rubber
136-1707-CW	--	Chrome	Chrome	10' (3m)	White Rubber
136-1708-CW	--	Chrome	Chrome	6' (1.8m)	Stainless Steel
136-1700-KP	--	Black	Black	6' (1.8m)	Black Rubber
136-1708-KP	--	Black	Black	6' (1.8m)	Stainless Steel

Bulkhead Sprayer Holders

sold separately (see page 39)



Transom Shower

Plastic Lid

- UV protected heavy duty ABS plastic lid and cup
- Integrated Aidack™ Control Valve (Hot/Cold)
- Heavy duty, UV protected, ABS plastic and chrome plated brass sprayer
- Complete water shut-off when trigger is not engaged
- Depressing trigger allows for intermittent water flow – lifting trigger locks it on for continuous water flow
- Vertical wall-mount, horizontal wall-mount (lid opening up or down) or deck-mount
- Heavy duty pull-out hose
- All brass valve body with metal handle
- Ceramic disc valve
- Flexible stainless steel braided supply line hoses
- Stainless steel mounting screws
- Two hole mount, 3" Ø (2 1/2" - 2 5/8" CC)
- Connections: 1/2" NPS-M

OEM #	Aftermarket #	Cup & Lid	Sprayer Finish	Hose Length	Hose Type
136-1712-AW	--	Arctic White	Arctic White & Chrome	6' (1.8m)	White Rubber
136-1714-AW	--	Arctic White	Arctic White & Chrome	10' (3m)	White Rubber
136-1716-AW	--	Arctic White	Arctic White & Chrome	6' (1.8m)	Stainless Steel
136-1712-WH	--	Warm White	Warm White & Chrome	6' (1.8m)	White Rubber
136-1714-WH	--	Warm White	Warm White & Chrome	10' (3m)	White Rubber
136-1716-WH	--	Warm White	Warm White & Chrome	6' (1.8m)	Stainless Steel
136-1712-CA	--	Chrome	Arctic White & Chrome	6' (1.8m)	White Rubber
136-1714-CA	--	Chrome	Arctic White & Chrome	10' (3m)	White Rubber
136-1716-CA	--	Chrome	Arctic White & Chrome	6' (1.8m)	Stainless Steel
136-1712-CW	--	Chrome	Warm White & Chrome	6' (1.8m)	White Rubber
136-1714-CW	--	Chrome	Warm White & Chrome	10' (3m)	White Rubber
136-1716-CW	--	Chrome	Warm White & Chrome	6' (1.8m)	Stainless Steel
136-1712-CP	--	Chrome	Black & Chrome	6' (1.8m)	Black Rubber
136-1716-CP	--	Chrome	Black & Chrome	6' (1.8m)	Stainless Steel
136-1712-KP	--	Black	Black & Chrome	6' (1.8m)	Black Rubber
136-1716-KP	--	Black	Black & Chrome	6' (1.8m)	Stainless Steel

OEM # – Not Labeled Or Packaged For Resale Aftermarket # – Labeled And Packaged For Resale NOTE: Dimension Drawings ±1/16" (for reference only – may not be to scale)

MARINE GRADE ONLY COLD TRANSOM SHOWERS

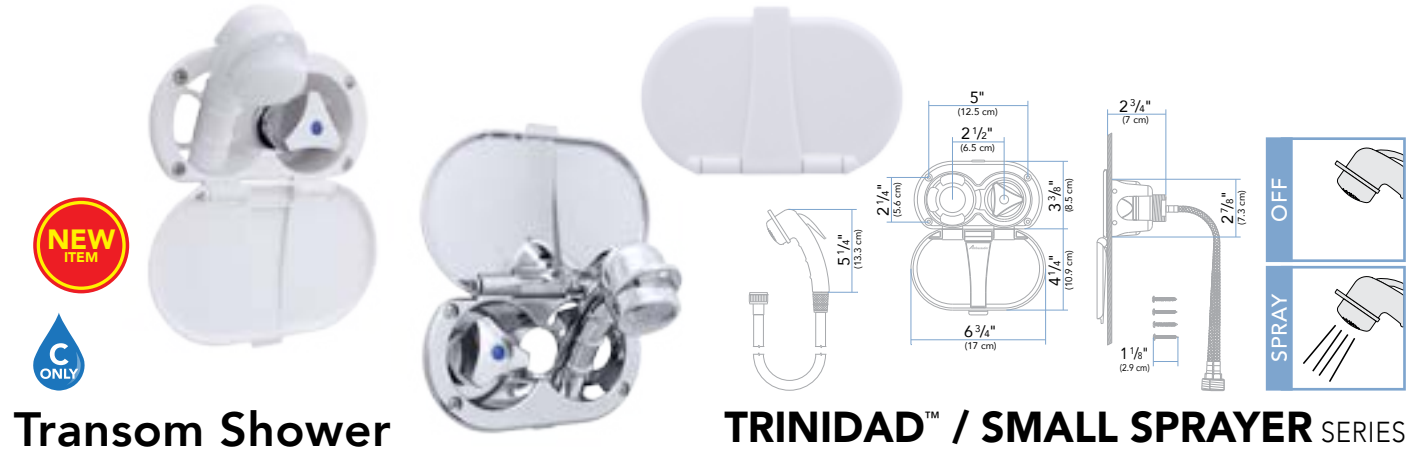

Transom Shower

Plastic Lid

- UV protected heavy duty ABS plastic lid and cup
- Integrated Trinidad™ Control Valve (Cold Only)
- Heavy duty, UV protected, ABS plastic sprayer
- Complete water shut-off when trigger is not engaged
- Depressing trigger allows for intermittent water flow – lifting trigger locks it on for continuous water flow
- Vertical wall-mount, horizontal wall-mount (lid opening up or down) or deck-mount
- Heavy duty pull-out hose
- All brass valve body with metal handle
- Ceramic disc valve
- Flexible stainless steel braided supply line hoses
- Stainless steel mounting screws
- Two hole mount, 3" Ø (2 1/2" - 2 5/8" CC)
- Connections: 1/2" NPS-M

OEM #	Aftermarket #	Cup & Lid	Sprayer Finish	Hose Length	Hose Type
136-0200-AW	--	Arctic White	Arctic White	6' (1.8m)	White Rubber
136-0207-AW	--	Arctic White	Arctic White	10' (3m)	White Rubber
136-0208-AW	--	Arctic White	Arctic White	6' (1.8m)	Stainless Steel
136-0200-WH	--	Warm White	Warm White	6' (1.8m)	White Rubber
136-0207-WH	--	Warm White	Warm White	10' (3m)	White Rubber
136-0208-WH	--	Warm White	Warm White	6' (1.8m)	Stainless Steel
136-0200-CP	--	Chrome	Chrome	6' (1.8m)	Black Rubber
136-0200-CW	--	Chrome	Chrome	6' (1.8m)	White Rubber
136-0207-CW	--	Chrome	Chrome	10' (3m)	White Rubber
136-0208-CW	--	Chrome	Chrome	6' (1.8m)	Stainless Steel
136-0200-KP	--	Black	Black	6' (1.8m)	Black Rubber
136-0208-KP	--	Black	Black	6' (1.8m)	Stainless Steel

Bulkhead Sprayer Holders

sold separately (see page 39)



Transom Shower

Plastic Lid

- UV protected heavy duty ABS plastic lid and cup
- Integrated Trinidad™ Control Valve (Cold Only)
- Heavy duty, UV protected, ABS plastic and chrome plated brass sprayer
- Complete water shut-off when trigger is not engaged
- Depressing trigger allows for intermittent water flow – lifting trigger locks it on for continuous water flow
- Vertical wall-mount, horizontal wall-mount (lid opening up or down) or deck-mount
- Heavy duty pull-out hose
- All brass valve body with metal handle
- Ceramic disc valve
- Flexible stainless steel braided supply line hoses
- Stainless steel mounting screws
- Two hole mount, 3" Ø (2 1/2" - 2 5/8" CC)
- Connections: 1/2" NPS-M

OEM #	Aftermarket #	Cup & Lid	Sprayer Finish	Hose Length	Hose Type
136-0212-AW	--	Arctic White	Arctic White & Chrome	6' (1.8m)	White Rubber
136-0214-AW	--	Arctic White	Arctic White & Chrome	10' (3m)	White Rubber
136-0216-AW	--	Arctic White	Arctic White & Chrome	6' (1.8m)	Stainless Steel
136-0212-WH	--	Warm White	Warm White & Chrome	6' (1.8m)	White Rubber
136-0214-WH	--	Warm White	Warm White & Chrome	10' (3m)	White Rubber
136-0216-WH	--	Warm White	Warm White & Chrome	6' (1.8m)	Stainless Steel
136-0212-CA	--	Chrome	Arctic White & Chrome	6' (1.8m)	White Rubber
136-0214-CA	--	Chrome	Arctic White & Chrome	10' (3m)	White Rubber
136-0216-CA	--	Chrome	Arctic White & Chrome	6' (1.8m)	Stainless Steel
136-0212-CW	--	Chrome	Warm White & Chrome	6' (1.8m)	White Rubber
136-0214-CW	--	Chrome	Warm White & Chrome	10' (3m)	White Rubber
136-0216-CW	--	Chrome	Warm White & Chrome	6' (1.8m)	Stainless Steel
136-0212-CP	--	Chrome	Black & Chrome	6' (1.8m)	Black Rubber
136-0216-CP	--	Chrome	Black & Chrome	6' (1.8m)	Stainless Steel
136-0212-KP	--	Black	Black & Chrome	6' (1.8m)	Black Rubber
136-0216-KP	--	Black	Black & Chrome	6' (1.8m)	Stainless Steel

OEM # – Not Labeled Or Packaged For Resale Aftermarket # – Labeled And Packaged For Resale NOTE: Dimension Drawings ±1/16" (for reference only – may not be to scale)



Recessed Shower

Stainless Steel Lid

- Solid cast 316 stainless steel lid with UV protected heavy duty ABS plastic cup
- Heavy duty, UV protected, ABS plastic sprayer
- Complete water shut-off when trigger is not engaged
- Depressing trigger allows for intermittent water flow – lifting trigger locks it on for continuous water flow
- Wall-mount (lid opening up or down) or deck-mount
- New stainless steel lid with gasket and redesigned ABS plastic cup form a tighter seal when lid is closed to prevent water from penetrating (NOTE: not guaranteed to be water-tight)
- Heavy duty pull-out hose
- Stainless steel mounting screws
- Single hole mount, 3" Ø
- Connection: 1/2" NPS-F

OEM #	Aftermarket #	Cup & Lid	Sprayer Finish	Hose Length	Hose Type
136-0040-AW	136-0040-AW-R	Arctic White & Stainless Steel	Arctic White	6' (1.8m)	White Rubber
136-0047-AW	136-0047-AW-R	Arctic White & Stainless Steel	Arctic White	10' (3m)	White Rubber
136-0048-AW	136-0048-AW-R	Arctic White & Stainless Steel	Arctic White	6' (1.8m)	Stainless Steel
136-0040-WH	136-0040-WH-R	Warm White & Stainless Steel	Warm White	6' (1.8m)	White Rubber
136-0047-WH	136-0047-WH-R	Warm White & Stainless Steel	Warm White	10' (3m)	White Rubber
136-0048-WH	136-0048-WH-R	Warm White & Stainless Steel	Warm White	6' (1.8m)	Stainless Steel
136-0040-CP	136-0040-CP-R	Chrome & Stainless Steel	Chrome	6' (1.8m)	Black Rubber
136-0040-CW	137-0040-CW	Chrome & Stainless Steel	Chrome	6' (1.8m)	White Rubber
136-0047-CW	136-0047-CW-R	Chrome & Stainless Steel	Chrome	10' (3m)	White Rubber
136-0048-CP	136-0048-CP-R	Chrome & Stainless Steel	Chrome	6' (1.8m)	Stainless Steel
136-0040-KP	136-0040-KP-R	Black & Stainless Steel	Black	6' (1.8m)	Black Rubber
136-0048-KP	136-0048-KP-R	Black & Stainless Steel	Black	6' (1.8m)	Stainless Steel

SMALL SPRAYER SERIES

Bulkhead Sprayer Holders

sold separately (see page 39)



Recessed Shower

Stainless Steel Lid

- Solid cast 316 stainless steel lid with UV protected heavy duty ABS plastic cup
- Heavy duty, UV protected, ABS plastic and chrome plated brass sprayer
- Complete water shut-off when trigger is not engaged
- Depressing trigger allows for intermittent water flow – lifting trigger locks it on for continuous water flow
- Wall-mount (lid opening up or down) or deck-mount
- New stainless steel lid with gasket and redesigned ABS plastic cup form a tighter seal when lid is closed to prevent water from penetrating (NOTE: not guaranteed to be water-tight)
- Heavy duty pull-out hose
- Stainless steel mounting screws
- Single hole mount, 3" Ø
- Connection: 1/2" NPS-F

OEM #	Aftermarket #	Cup & Lid	Sprayer Finish	Hose Length	Hose Type
136-0042-AW	136-0042-AW-R	Arctic White & Stainless Steel	Arctic White & Chrome	6' (1.8m)	White Rubber
136-0044-AW	136-0044-AW-R	Arctic White & Stainless Steel	Arctic White & Chrome	10' (3m)	White Rubber
136-0043-AW	136-0043-AW-R	Arctic White & Stainless Steel	Arctic White & Chrome	6' (1.8m)	Stainless Steel
136-0042-WH	136-0042-WH-R	Warm White & Stainless Steel	Warm White & Chrome	6' (1.8m)	White Rubber
136-0044-WH	136-0044-WH-R	Warm White & Stainless Steel	Warm White & Chrome	10' (3m)	White Rubber
136-0043-WH	136-0043-WH-R	Warm White & Stainless Steel	Warm White & Chrome	6' (1.8m)	Stainless Steel
136-0042-CA	136-0042-CA-R	Chrome & Stainless Steel	Arctic White & Chrome	6' (1.8m)	White Rubber
136-0044-CA	136-0044-CA-R	Chrome & Stainless Steel	Arctic White & Chrome	10' (3m)	White Rubber
136-0043-CA	136-0043-CA-R	Chrome & Stainless Steel	Arctic White & Chrome	6' (1.8m)	Stainless Steel
136-0042-CW	136-0042-CW-R	Chrome & Stainless Steel	Warm White & Chrome	6' (1.8m)	White Rubber
136-0044-CW	136-0044-CW-R	Chrome & Stainless Steel	Warm White & Chrome	10' (3m)	White Rubber
136-0043-CW	136-0043-CW-R	Chrome & Stainless Steel	Warm White & Chrome	6' (1.8m)	Stainless Steel
136-0042-CP	136-0042-CP-R	Chrome & Stainless Steel	Black & Chrome	6' (1.8m)	Black Rubber
136-0043-CP	136-0043-CP-R	Chrome & Stainless Steel	Black & Chrome	6' (1.8m)	Stainless Steel
136-0042-KP	136-0042-KP-R	Black & Stainless Steel	Black & Chrome	6' (1.8m)	Black Rubber
136-0043-KP	136-0043-KP-R	Black & Stainless Steel	Black & Chrome	6' (1.8m)	Stainless Steel

HAMMER-HEAD SPRAYER SERIES



Recessed Shower

Plastic Lid

- UV protected heavy duty ABS plastic lid and cup
- Heavy duty, UV protected, ABS plastic sprayer
- Complete water shut-off when trigger is not engaged
- Depressing trigger allows for intermittent water flow – lifting trigger locks it on for continuous water flow
- Wall-mount (lid opening up or down) or deck-mount
- Heavy duty pull-out hose
- Stainless steel mounting screws
- Single hole mount, 3" Ø
- Connection: 1/2" NPS-F

OEM #	Aftermarket #	Cup & Lid	Sprayer Finish	Hose Length	Hose Type
136-0000-AW	136-0000-AW-R	Arctic White	Arctic White	6' (1.8m)	White Rubber
136-0007-AW	136-0007-AW-R	Arctic White	Arctic White	10' (3m)	White Rubber
136-0008-AW	136-0008-AW-R	Arctic White	Arctic White	6' (1.8m)	Stainless Steel
136-0000-WH	137-0000-WH	Warm White	Warm White	6' (1.8m)	White Rubber
136-0007-WH	136-0007-WH-R	Warm White	Warm White	10' (3m)	White Rubber
136-0008-WH	136-0008-WH-R	Warm White	Warm White	6' (1.8m)	Stainless Steel
136-0000-CP	136-0000-CP-R	Chrome	Chrome	6' (1.8m)	Black Rubber
136-0000-CW	136-0000-CW-R	Chrome	Chrome	6' (1.8m)	White Rubber
136-0007-CW	136-0007-CW-R	Chrome	Chrome	10' (3m)	White Rubber
136-0008-CP	136-0008-CP-R	Chrome	Chrome	6' (1.8m)	Stainless Steel
136-0000-KP	136-0000-KP-R	Black	Black	6' (1.8m)	Black Rubber
136-0008-KP	136-0008-KP-R	Black	Black	6' (1.8m)	Stainless Steel

Bulkhead Sprayer Holders

sold separately (see page 39)



Recessed Shower

Plastic Lid

- UV protected heavy duty ABS plastic lid and cup
- Heavy duty, UV protected, ABS plastic and chrome plated brass sprayer
- Complete water shut-off when trigger is not engaged
- Depressing trigger allows for intermittent water flow – lifting trigger locks it on for continuous water flow
- Wall-mount (lid opening up or down) or deck-mount
- Heavy duty pull-out hose
- Stainless steel mounting screws
- Single hole mount, 3" Ø
- Connection: 1/2" NPS-F

OEM #	Aftermarket #	Cup & Lid	Sprayer Finish	Hose Length	Hose Type
136-0012-AW	136-0012-AW-R	Arctic White	Arctic White & Chrome	6' (1.8m)	White Rubber
136-0014-AW	136-0014-AW-R	Arctic White	Arctic White & Chrome	10' (3m)	White Rubber
136-0016-AW	136-0016-AW-R	Arctic White	Arctic White & Chrome	6' (1.8m)	Stainless Steel
136-0012-WH	136-0012-WH-R	Warm White	Warm White & Chrome	6' (1.8m)	White Rubber
136-0014-WH	136-0014-WH-R	Warm White	Warm White & Chrome	10' (3m)	White Rubber
136-0016-WH	136-0016-WH-R	Warm White	Warm White & Chrome	6' (1.8m)	Stainless Steel
136-0012-CA	136-0012-CA-R	Chrome	Arctic White & Chrome	6' (1.8m)	White Rubber
136-0014-CA	136-0014-CA-R	Chrome	Arctic White & Chrome	10' (3m)	White Rubber
136-0016-CA	136-0016-CA-R	Chrome	Arctic White & Chrome	6' (1.8m)	Stainless Steel
136-0012-CW	136-0012-CW-R	Chrome	Warm White & Chrome	6' (1.8m)	White Rubber
136-0014-CW	136-0014-CW-R	Chrome	Warm White & Chrome	10' (3m)	White Rubber
136-0016-CW	136-0016-CW-R	Chrome	Warm White & Chrome	6' (1.8m)	Stainless Steel
136-0012-CP	136-0012-CP-R	Chrome	Black & Chrome	6' (1.8m)	Black Rubber
136-0016-CP	136-0016-CP-R	Chrome	Black & Chrome	6' (1.8m)	Stainless Steel
136-0012-KP	136-0012-KP-R	Black	Black & Chrome	6' (1.8m)	Black Rubber
136-0016-KP	136-0016-KP-R	Black	Black & Chrome	6' (1.8m)	Stainless Steel

HAMMER-HEAD SPRAYER SERIES

RECESSED CONTROL VALVES

MARINE GRADE



Recessed Control Valve

	OEM #	Aftermarket #	Cup & Lid	Lid Style	Control Valve Finish
• Solid cast 316 stainless steel lid or UV protected heavy duty ABS plastic lid with UV protected heavy duty ABS plastic cup	136-1741-CA	--	Arctic White & Stainless Steel	316 Stainless Steel	Chrome
	136-1741-CW	--	Warm White & Stainless Steel	316 Stainless Steel	Chrome
	136-1741-CP	--	Chrome & Stainless Steel	316 Stainless Steel	Chrome
• Integrated Aidack™ Control Valve (Hot/Cold)	136-1741-CK	--	Black & Stainless Steel	316 Stainless Steel	Chrome
• Wall-mount (lid opening up or down) or deck-mount	136-1711-CA	--	Arctic White	ABS Plastic	Chrome
• New stainless steel lid with gasket and redesigned ABS plastic cup form a tighter seal when lid is closed to prevent water from penetrating (NOTE: not guaranteed to be water-tight)	136-1711-CW	--	Warm White	ABS Plastic	Chrome
	136-1711-CP	--	Chrome	ABS Plastic	Chrome
	136-1711-CK	--	Black	ABS Plastic	Chrome

- All brass valve body with metal handle
- Ceramic disc valve
- Flexible stainless steel braided supply line hoses
- Stainless steel mounting screws
- Single hole mount, 3" Ø
- Connections: 1/2" NPS-M



Recessed Control Valve

	OEM #	Aftermarket #	Cup & Lid	Lid Style	Control Valve Finish
• Solid cast 316 stainless steel lid or UV protected heavy duty ABS plastic lid with UV protected heavy duty ABS plastic cup	136-0249-CA	--	Arctic White & Stainless Steel	316 Stainless Steel	Chrome
	136-0249-CW	--	Warm White & Stainless Steel	316 Stainless Steel	Chrome
	136-0249-CP	--	Chrome & Stainless Steel	316 Stainless Steel	Chrome
• Integrated Trinidad™ Control Valve (Cold Only)	136-0249-CK	--	Black & Stainless Steel	316 Stainless Steel	Chrome
• Wall-mount (lid opening up or down) or deck-mount	136-0209-CA	--	Arctic White	ABS Plastic	Chrome
• New stainless steel lid with gasket and redesigned ABS plastic cup form a tighter seal when lid is closed to prevent water from penetrating (NOTE: not guaranteed to be water-tight)	136-0209-CW	--	Warm White	ABS Plastic	Chrome
	136-0209-CP	--	Chrome	ABS Plastic	Chrome
	136-0209-CK	--	Black	ABS Plastic	Chrome

- All brass valve body with metal handle
- Ceramic disc valve
- Flexible stainless steel braided supply line hoses
- Stainless steel mounting screws
- Single hole mount, 3" Ø
- Connections: 1/2" NPS-M

OEM # - Not Labeled Or Packaged For Resale Aftermarket # - Labeled And Packaged For Resale NOTE: Dimension Drawings ±1/8" (for reference only - may not be to scale)

MARINE GRADE

TRANSOM & RECESSED ACCESSORIES



Transom Cup & Lid Set

	OEM #	Aftermarket #	Cup & Lid	Lid Style
• Solid cast 316 stainless steel lid or UV protected heavy duty ABS plastic lid with UV protected heavy duty ABS plastic cup	136-0025-AW	--	Arctic White & Stainless Steel	316 Stainless Steel
	136-0025-WH	--	Warm White & Stainless Steel	316 Stainless Steel
	136-0025-CP	--	Chrome & Stainless Steel	316 Stainless Steel
	136-0025-KP	--	Black & Stainless Steel	316 Stainless Steel
• Vertical wall-mount, horizontal wall-mount (lid opening up or down) or deck-mount	136-0010-AW	--	Arctic White	ABS Plastic
• Stainless steel lid with gasket forms a tighter seal when lid is closed to prevent water from penetrating (NOTE: not guaranteed to be water-tight)	136-0010-WH	--	Warm White	ABS Plastic
	136-0010-CP	--	Chrome	ABS Plastic
	136-0010-KP	--	Black	ABS Plastic

- Two hole mount, 3" Ø (2 1/2" - 2 5/8" CC)
- For use with Ambassador Marine Transom Showers and Control Valves



Recessed Cup & Lid Set

	OEM #	Aftermarket #	Cup & Lid	Lid Style
• Solid cast 316 stainless steel lid or UV protected heavy duty ABS plastic lid with UV protected heavy duty ABS plastic cup	136-0015-AW	--	Arctic White & Stainless Steel	316 Stainless Steel
	136-0015-WH	--	Warm White & Stainless Steel	316 Stainless Steel
	136-0015-CP	--	Chrome & Stainless Steel	316 Stainless Steel
	136-0015-KP	--	Black & Stainless Steel	316 Stainless Steel
• Wall-mount (lid opening up or down) or deck-mount	136-0005-AW	--	Arctic White	ABS Plastic
• New stainless steel lid with gasket and redesigned ABS plastic cup form a tighter seal when lid is closed to prevent water from penetrating (NOTE: not guaranteed to be water-tight)	136-0005-WH	--	Warm White	ABS Plastic
	136-0005-CP	--	Chrome	ABS Plastic
	136-0005-KP	--	Black	ABS Plastic

- Stainless steel mounting screws
- Single hole mount, 3" Ø
- For use with Ambassador Marine Recessed Showers and Control Valves



Recessed Shower sold separately

Mesh Bag

- Breathable nylon mesh
- 4x fastening push-in plastic rivets
- Easy installation
- Side or bottom supply access with plastic tie to secure
- Works with all Ambassador Marine Transom and Recessed Shower styles

OEM #	Aftermarket #	Finish
136-0090-KP	137-0090-KP	Black

OEM # - Not Labeled Or Packaged For Resale Aftermarket # - Labeled And Packaged For Resale NOTE: Dimension Drawings ±1/8" (for reference only - may not be to scale)

DECK-MOUNT SPRAYERS

MARINE GRADE

NEW FINISH

NEW HOLDER



Deck-Mount Sprayer

With Elbow

- Heavy duty, UV protected, ABS plastic and chrome plated brass sprayer
- Complete water shut-off when trigger is not engaged
- Depressing trigger allows for intermittent water flow – lifting trigger locks it on for continuous water flow
- Ultra-low profile, chrome plated brass deck holder
- Heavy duty pull-out hose
- Single hole mount, 1" - 1 1/4" Ø
- Connection: 1/2" NPS-F

OEM #	Aftermarket #	Sprayer Finish	Integrated Hook	Hose Length	Hose Type
134-0009-AW	134-0009-AW-R	Arctic White & Chrome	Yes	6' (1.8m)	White Rubber
134-0033-AW	134-0033-AW-R	Arctic White & Chrome	Yes	10' (3m)	White Rubber
134-0031-AW	134-0031-AW-R	Arctic White & Chrome	Yes	6' (1.8m)	Stainless Steel
134-0020-AW	134-0020-AW-R	Arctic White & Chrome	No	6' (1.8m)	White Rubber
134-0048-AW	134-0048-AW-R	Arctic White & Chrome	No	10' (3m)	White Rubber
134-0036-AW	134-0036-AW-R	Arctic White & Chrome	No	6' (1.8m)	Stainless Steel
134-0009-WH	134-0009-WH-R	Warm White & Chrome	Yes	6' (1.8m)	White Rubber
134-0033-WH	134-0033-WH-R	Warm White & Chrome	Yes	10' (3m)	White Rubber
134-0031-WH	134-0031-WH-R	Warm White & Chrome	Yes	6' (1.8m)	Stainless Steel
134-0020-WH	134-0020-WH-R	Warm White & Chrome	No	6' (1.8m)	White Rubber
134-0048-WH	134-0048-WH-R	Warm White & Chrome	No	10' (3m)	White Rubber
134-0036-WH	134-0036-WH-R	Warm White & Chrome	No	6' (1.8m)	Stainless Steel
134-0009-CP	134-0009-CP-R	Chrome	Yes	6' (1.8m)	Black Rubber
134-0009-CW	134-0009-CW-R	Chrome	Yes	6' (1.8m)	White Rubber
134-0033-CW	134-0033-CW-R	Chrome	Yes	10' (3m)	White Rubber
134-0031-CP	134-0031-CP-R	Chrome	Yes	6' (1.8m)	Stainless Steel
134-0020-CP	134-0020-CP-R	Chrome	No	6' (1.8m)	Black Rubber
134-0020-CW	134-0020-CW-R	Chrome	No	6' (1.8m)	White Rubber
134-0048-CW	134-0048-CW-R	Chrome	No	10' (3m)	White Rubber
134-0036-CP	134-0036-CP-R	Chrome	No	6' (1.8m)	Stainless Steel
134-0009-KP	134-0009-KP-R	Black & Chrome	Yes	6' (1.8m)	Black Rubber
134-0031-KP	134-0031-KP-R	Black & Chrome	Yes	6' (1.8m)	Stainless Steel
134-0020-KP	134-0020-KP-R	Black & Chrome	No	6' (1.8m)	Black Rubber
134-0036-KP	134-0036-KP-R	Black & Chrome	No	6' (1.8m)	Stainless Steel

SMALL SPRAYER SERIES

MARINE GRADE

DECK-MOUNT SPRAYERS

NEW HOLDER



Deck-Mount Sprayer

With Elbow

- Heavy duty, UV protected, ABS plastic and chrome plated brass sprayer
- Complete water shut-off when trigger is not engaged
- Depressing trigger allows for intermittent water flow – lifting trigger locks it on for continuous water flow
- Ultra-low profile, chrome plated brass deck holder
- Heavy duty pull-out hose
- Single hole mount, 1" - 1 1/4" Ø
- Connection: 1/2" NPS-F

OEM #	Aftermarket #	Sprayer Finish	Integrated Hook	Hose Length	Hose Type
134-0008-WH	134-0008-WH-R	Warm White & Chrome	Yes	6' (1.8m)	White Rubber
134-0058-WH	134-0058-WH-R	Warm White & Chrome	Yes	10' (3m)	White Rubber
134-0057-WH	134-0057-WH-R	Warm White & Chrome	Yes	6' (1.8m)	Stainless Steel
134-0059-WH	134-0059-WH-R	Warm White & Chrome	No	6' (1.8m)	White Rubber
134-0061-WH	134-0061-WH-R	Warm White & Chrome	No	10' (3m)	White Rubber
134-0060-WH	134-0060-WH-R	Warm White & Chrome	No	6' (1.8m)	Stainless Steel
134-0008-CP	134-0008-CP-R	Chrome	Yes	6' (1.8m)	Black Rubber
134-0008-CW	134-0008-CW-R	Chrome	Yes	6' (1.8m)	White Rubber
134-0058-CW	134-0058-CW-R	Chrome	Yes	10' (3m)	White Rubber
134-0057-CP	134-0057-CP-R	Chrome	Yes	6' (1.8m)	Stainless Steel
134-0059-CP	134-0059-CP-R	Chrome	No	6' (1.8m)	Black Rubber
134-0059-CW	134-0059-CW-R	Chrome	No	6' (1.8m)	White Rubber
134-0061-CW	134-0061-CW-R	Chrome	No	10' (3m)	White Rubber
134-0060-CP	134-0060-CP-R	Chrome	No	6' (1.8m)	Stainless Steel
134-0008-KP	134-0008-KP-R	Black & Chrome	Yes	6' (1.8m)	Black Rubber
134-0057-KP	134-0057-KP-R	Black & Chrome	Yes	6' (1.8m)	Stainless Steel
134-0059-KP	134-0059-KP-R	Black & Chrome	No	6' (1.8m)	Black Rubber
134-0060-KP	134-0060-KP-R	Black & Chrome	No	6' (1.8m)	Stainless Steel

LARGE SPRAYER SERIES

Bulkhead Sprayer Holders
sold separately (see page 39)



NEW FINISH

NEW HOLDER

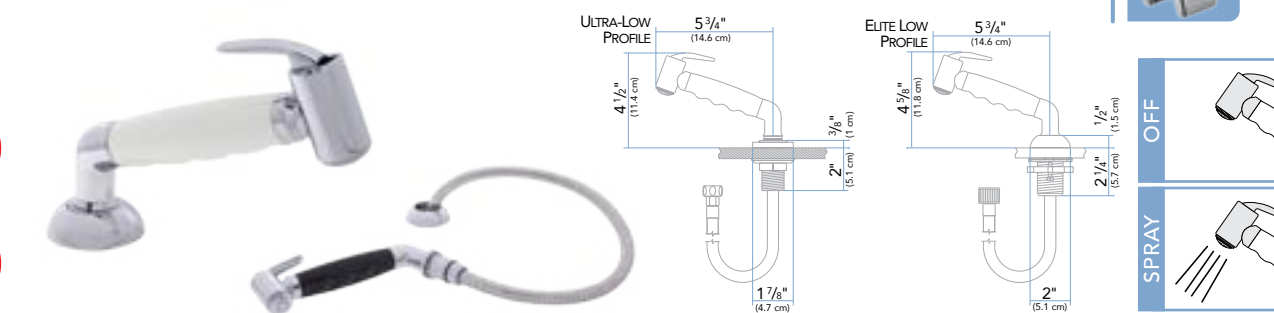

Deck-Mount Sprayer

With Elbow

- Heavy duty, UV protected, ABS plastic and chrome plated brass sprayer
- Complete water shut-off when trigger is not engaged
- Depressing trigger allows for intermittent water flow – lifting trigger locks it on for continuous water flow
- Ultra-low profile or elite low profile, chrome plated brass deck holder
- Heavy duty pull-out hose
- Single hole mount, 1" - 1 1/4" Ø
- Connection: 1/2" NPS-F

OEM #	Aftermarket #	Sprayer Finish	Integrated Hook	Hose Length	Hose Type
134-0041-AW	134-0041-AW-R	Arctic White & Chrome	No	6' (1.8m)	White Rubber
134-0043-AW	134-0043-AW-R	Arctic White & Chrome	No	10' (3m)	White Rubber
134-0045-AW	134-0045-AW-R	Arctic White & Chrome	No	6' (1.8m)	Stainless Steel
134-0041-WH	134-0041-WH-R	Warm White & Chrome	No	6' (1.8m)	White Rubber
134-0043-WH	134-0043-WH-R	Warm White & Chrome	No	10' (3m)	White Rubber
134-0045-WH	134-0045-WH-R	Warm White & Chrome	No	6' (1.8m)	Stainless Steel
134-0041-KP	134-0041-KP-R	Black & Chrome	No	6' (1.8m)	Black Rubber
134-0045-KP	134-0045-KP-R	Black & Chrome	No	6' (1.8m)	Stainless Steel

HAMMER-HEAD SPRAYER SERIES

NEW FINISH

NEW HOLDER



Deck-Mount Sprayer

With Elbow

- 2-function spray/aerated stream with water conserving "stand-by" button (NOTE: "stand-by" is NOT a complete water shut-off, it allows a small amount of water to continue to trickle)
- Heavy duty, UV protected, ABS plastic and chrome plated brass sprayer
- Ultra-low profile, chrome plated brass deck holder
- Heavy duty pull-out hose
- Single hole mount, 1" - 1 1/4" Ø
- Connection: 1/2" NPS-F

OEM #	Aftermarket #	Sprayer Finish	Integrated Hook	Hose Length	Hose Type
134-0012-AW	134-0012-AW-R	Arctic White & Chrome	--	6' (1.8m)	White Rubber
134-0035-AW	134-0035-AW-R	Arctic White & Chrome	--	10' (3m)	White Rubber
134-0034-AW	134-0034-AW-R	Arctic White & Chrome	--	6' (1.8m)	Stainless Steel
134-0012-WH	134-0012-WH-R	Warm White & Chrome	--	6' (1.8m)	White Rubber
134-0035-WH	134-0035-WH-R	Warm White & Chrome	--	10' (3m)	White Rubber
134-0034-WH	134-0034-WH-R	Warm White & Chrome	--	6' (1.8m)	Stainless Steel
134-0012-KP	134-0012-KP-R	Black & Chrome	--	6' (1.8m)	Black Rubber
134-0034-KP	134-0034-KP-R	Black & Chrome	--	6' (1.8m)	Stainless Steel

CLASSIC SPRAYER SERIES

OEM # - Not Labeled Or Packaged For Resale Aftermarket # - Labeled And Packaged For Resale

NOTE: Dimension Drawings ±1/16" (for reference only - may not be to scale) = To Be Refreshed/Replaced When Inventory Is Depleted

OEM # - Not Labeled Or Packaged For Resale Available While Supplies Last

Aftermarket # - Labeled And Packaged For Resale

NOTE: Dimension Drawings ±1/16" (for reference only - may not be to scale)

For more information, please visit ambassadormarine.com

DECK-MOUNT SPRAYERS

MARINE GRADE

NEW FINISH

NEW HOLDER



Deck-Mount Sprayer

SMALL SPRAYER SERIES

	OEM #	Aftermarket #	Sprayer Finish	Integrated Hook	Hose Length	Hose Type
• Heavy duty, UV protected, ABS plastic sprayer	134-0011-AW	134-0011-AW-R	Arctic White	Yes	6' (1.8m)	White Rubber
• Complete water shut-off when trigger is not engaged	134-0021-AW	134-0021-AW-R	Arctic White	Yes	10' (3m)	White Rubber
• Depressing trigger allows for intermittent water flow – lifting trigger locks it on for continuous water flow	134-0023-AW	134-0023-AW-R	Arctic White	Yes	6' (1.8m)	Stainless Steel
• Ultra-low profile, chrome plated brass deck holder	134-0049-AW	134-0049-AW-R	Arctic White	No	6' (1.8m)	White Rubber
• Heavy duty pull-out hose	134-0051-AW	134-0051-AW-R	Arctic White	No	10' (3m)	White Rubber
• Single hole mount, 1" - 1 1/4" Ø	134-0050-AW	134-0050-AW-R	Arctic White	No	6' (1.8m)	Stainless Steel
• Connection: 1/2" NPS-F	134-0011-WH	135-0011-WH	Warm White	Yes	6' (1.8m)	White Rubber
	134-0021-WH	134-0021-WH-R	Warm White	Yes	10' (3m)	White Rubber
	134-0023-WH	134-0023-WH-R	Warm White	Yes	6' (1.8m)	Stainless Steel
	134-0049-WH	134-0049-WH-R	Warm White	No	6' (1.8m)	White Rubber
	134-0051-WH	134-0051-WH-R	Warm White	No	10' (3m)	White Rubber
	134-0050-WH	134-0050-WH-R	Warm White	No	6' (1.8m)	Stainless Steel
	134-0011-CP	134-0011-CP-R	Chrome	Yes	6' (1.8m)	Black Rubber
	134-0011-CW	134-0011-CW-R	Chrome	Yes	6' (1.8m)	White Rubber
	134-0021-CW	134-0021-CW-R	Chrome	Yes	10' (3m)	White Rubber
	134-0023-CP	134-0023-CP-R	Chrome	Yes	6' (1.8m)	Stainless Steel
	134-0049-CP	134-0049-CP-R	Chrome	No	6' (1.8m)	Black Rubber
	134-0049-CW	134-0049-CW-R	Chrome	No	6' (1.8m)	White Rubber
	134-0051-CW	134-0051-CW-R	Chrome	No	10' (3m)	White Rubber
	134-0050-CP	134-0050-CP-R	Chrome	No	6' (1.8m)	Stainless Steel
	134-0011-KP	134-0011-KP-R	Black	Yes	6' (1.8m)	Black Rubber
	134-0023-KP	134-0023-KP-R	Black	Yes	6' (1.8m)	Stainless Steel
	134-0049-KP	134-0049-KP-R	Black	No	6' (1.8m)	Black Rubber
	134-0050-KP	134-0050-KP-R	Black	No	6' (1.8m)	Stainless Steel



Deck-Mount Sprayer

HAMMER-HEAD SPRAYER SERIES

	OEM #	Aftermarket #	Sprayer Finish	Integrated Hook	Hose Length	Hose Type
• Heavy duty, UV protected, ABS plastic and chrome plated brass sprayer	134-0040-AW	134-0040-AW-R	Arctic White & Chrome	No	6' (1.8m)	White Rubber
• Complete water shut-off when trigger is not engaged	134-0042-AW	134-0042-AW-R	Arctic White & Chrome	No	10' (3m)	White Rubber
• Depressing trigger allows for intermittent water flow – lifting trigger locks it on for continuous water flow	134-0044-AW	134-0044-AW-R	Arctic White & Chrome	No	6' (1.8m)	Stainless Steel
• Ultra-low profile or elite low profile, chrome plated brass deck holder	134-0040-WH	134-0040-WH-R	Warm White & Chrome	No	6' (1.8m)	White Rubber
• Heavy duty pull-out hose	134-0042-WH	134-0042-WH-R	Warm White & Chrome	No	10' (3m)	White Rubber
• Single hole mount, 1" - 1 1/4" Ø	134-0044-WH	134-0044-WH-R	Warm White & Chrome	No	6' (1.8m)	Stainless Steel
• Connection: 1/2" NPS-F	134-0040-KP	134-0040-KP-R	Black & Chrome	No	6' (1.8m)	Black Rubber
	134-0042-KP	134-0042-KP-R	Black & Chrome	No	6' (1.8m)	Stainless Steel

OEM # – Not Labeled Or Packaged For Resale Aftermarket # – Labeled And Packaged For Resale

NOTE: Dimension Drawings ±1/16" (for reference only – may not be to scale) = To Be Refreshed/Replaced When Inventory Is Depleted

MARINE GRADE

DECK-MOUNT SPRAYERS

NEW HOLDER



Deck-Mount Sprayer

LARGE SPRAYER SERIES

	OEM #	Aftermarket #	Sprayer Finish	Integrated Hook	Hose Length	Hose Type
• Heavy duty, UV protected, ABS plastic sprayer	134-0010-WH	--	Warm White	Yes	6' (1.8m)	White Rubber
• Complete water shut-off when trigger is not engaged	134-0052-WH	--	Warm White	Yes	10' (3m)	White Rubber
• Depressing trigger allows for intermittent water flow – lifting trigger locks it on for continuous water flow	134-0054-WH	--	Warm White	Yes	6' (1.8m)	Stainless Steel
• Ultra-low profile, chrome plated brass deck holder	134-0056-WH	--	Warm White	No	6' (1.8m)	White Rubber
• Heavy duty pull-out hose	134-0055-WH	--	Warm White	No	10' (3m)	White Rubber
• Single hole mount, 1" - 1 1/4" Ø	134-0010-CP	--	Chrome	Yes	6' (1.8m)	Black Rubber
• Connection: 1/2" NPS-F	134-0010-CW	--	Chrome	Yes	6' (1.8m)	White Rubber
	134-0053-CW	--	Chrome	Yes	10' (3m)	White Rubber
	134-0052-CP	--	Chrome	Yes	6' (1.8m)	Stainless Steel
	134-0054-CP	--	Chrome	No	6' (1.8m)	Black Rubber
	134-0054-CW	--	Chrome	No	6' (1.8m)	White Rubber
	134-0056-CW	--	Chrome	No	10' (3m)	White Rubber
	134-0055-CP	--	Chrome	No	6' (1.8m)	Stainless Steel
	134-0010-KP	--	Black	Yes	6' (1.8m)	Black Rubber
	134-0052-KP	--	Black	Yes	6' (1.8m)	Stainless Steel
	134-0054-KP	--	Black	No	6' (1.8m)	Black Rubber
	134-0055-KP	--	Black	No	6' (1.8m)	Stainless Steel

Bulkhead Sprayer Holders sold separately (see page 39)



CONTROL VALVES COLD ONLY

MARINE GRADE

NEW DESIGN

C ONLY

Control Valve Thin Wall / Fiberglass Mount

- Wall or deck mounting option
- Designed for thin (fiberglass) walls/surfaces
- All brass valve body with metal handle
- Flexible stainless steel braided supply line hoses
- Ceramic disc valve
- Easy installation – mounts directly to bulkhead/deck (no strapping required)
- Single hole mount, 1 1/4" Ø
- Connections: 1/2" NPS-M



TRINIDAD™ SERIES

OEM #	Aftermarket #	Finish
136-0204-CP	--	Chrome

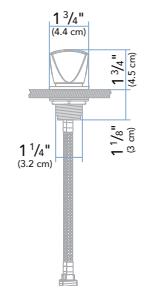

OEM # – Not Labeled Or Packaged For Resale Aftermarket # – Labeled And Packaged For Resale

NOTE: Dimension Drawings ±1/16" (for reference only – may not be to scale) = Available While Supplies Last

NOTE: Dimension Drawings ±1/16" (for reference only – may not be to scale)

CONTROL VALVES HOT/COLD

MARINE GRADE

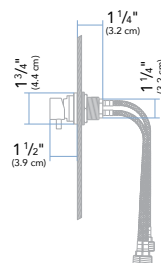

Control Valve Thin Wall / Fiberglass Mount

- Wall or deck mounting option
- Designed for thin (fiberglass) walls/surfaces
- All brass valve body with metal handle
- Flexible stainless steel braided supply line hoses
- Ceramic disc valve
- Easy installation – mounts directly to bulkhead/deck (no strapping required)
- Single hole mount, 1 1/4" Ø
- Connections: 1/2" NPS-M

OEM #	Aftermarket #	Finish
136-1706-CP	--	Chrome

AIDACK™ SERIES

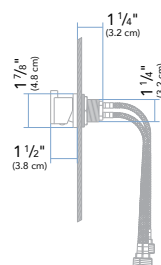

Control Valve Thin Wall / Fiberglass Mount

- Wall or deck mounting option
- Designed for thin (fiberglass) walls/surfaces
- All brass valve body with metal handle
- Flexible stainless steel braided supply line hoses
- Ceramic disc valve
- Easy installation – mounts directly to bulkhead/deck (no strapping required)
- Single hole mount, 1 1/4" Ø
- Connections: 1/2" NPS-M

OEM #	Aftermarket #	Finish
136-2006-CP	--	Chrome
136-2006-NP	--	Brushed Nickel

ARTAINÉ™ SERIES

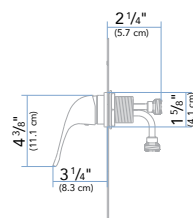

Control Valve Thin Wall / Fiberglass Mount

- Wall or deck mounting option
- Designed for thin (fiberglass) walls/surfaces
- All brass valve body with metal handle
- Ceramic disc valve
- Easy installation – mounts directly to bulkhead/deck (no strapping required)
- Single hole mount, 1 1/4" Ø
- Connections: 1/2" NPS-M

OEM #	Aftermarket #	Finish
136-0106-CP≈	--	Chrome

STASIS™ SERIES

MARINE GRADE

WATER INLETS & OUTLETS



Water Inlet

- Solid cast 316 stainless steel body and spin-nut
- Vinyl coated steel cable with chrome plated heavy duty ABS plastic cap
- Uses #8 fasteners (not included)
- Single hole mount, 1 1/4" Ø
- Connections: 3/4" NH-F (standard garden hose) to 1/2" NPT-F

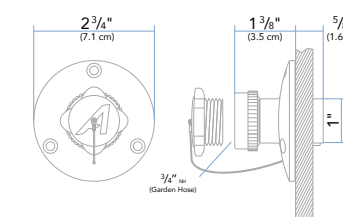

OEM #	Aftermarket #	Finish
P56-0191-SS	P56-0190-SS	Stainless Steel & Chrome



Water Outlet

- Solid cast 316 stainless steel body
- Vinyl coated steel cable with chrome plated heavy duty ABS plastic cap
- Uses #8 fasteners (not included)
- Single hole mount, 1 1/4" Ø
- Connections: 3/4" NH-M (standard garden hose) to 1/2" NPT-F

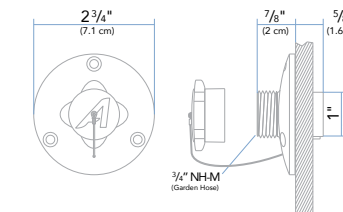

OEM #	Aftermarket #	Finish
P56-0201-SS	P56-0200-SS	Stainless Steel & Chrome

MARINE GRADE

SPIGOTS



Stainless Steel Spigot

- All cast 316 stainless steel body and handle
- All 316 stainless steel compression cartridge
- All 316 stainless steel mounting hardware
- Wall or deck mounting option
- Single hole mount, 3/4" - 1" Ø
- Connections: 1/2" NPS-M supply to 3/4" NH-M (standard garden hose)

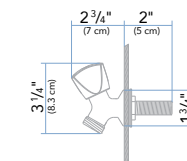

OEM #	Aftermarket #	Finish
--	133-0216-SS	Stainless Steel

TRINIDAD™ SERIES



SOLACE 415CS
FEATURING AIDACK™ ELITE FOLDING FAUCET# 132-1726-CP
& BUILD-IN SOAP DISPENSER# 130-0011-CP
& STAINLESS STEEL SINK# 544-1610-UM



Folding Tap



TRINIDAD™ SERIES

OEM #	Aftermarket #	Finish
--	133-0208-CP	Chrome

- Spout rotates 180° front/back
- All brass body and spout with metal handle
- Compression valve
- Single hole mount, 3/4" - 1" Ø
- Connection: 1/2" NPS-M

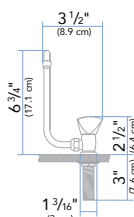

Elite Folding Tap J-Spout

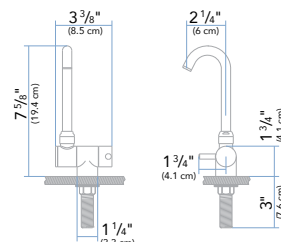

AIDACK™ SERIES

OEM #	Aftermarket #	Finish
132-1709-CP	--	Chrome

- Spout rotates 180° front/back and swivels 180° side/side
- All brass body and spout with metal handle
- Ceramic disc valve
- Single hole mount, 3/4" - 1" Ø
- Connection: 1/2" NPS-M



Elite Folding Tap J-Spout

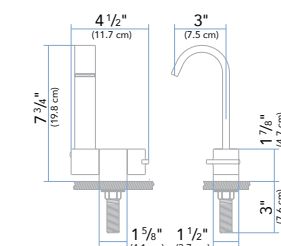

ARTAINE™ SERIES

OEM #	Aftermarket #	Finish
132-2009-CP	--	Chrome
132-2009-NP	--	Brushed Nickel

- Spout rotates 180° front/back and swivels 180° side/side
- All brass body and ribbon spout with metal handle
- Ceramic disc valve
- Single hole mount, 3/4" - 1" Ø
- Connection: 1/2" NPS-M



Elite Folding Tap J-Spout

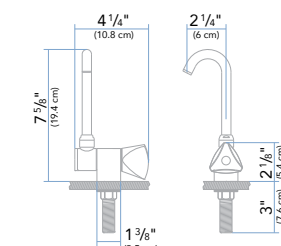

TRINIDAD™ SERIES

OEM #	Aftermarket #	Finish
--	133-0209-CP	Chrome

- Spout rotates 180° front/back and swivels 180° side/side
- All brass body and spout with metal handle
- Ceramic disc valve
- Single hole mount, 3/4" - 1" Ø
- Connection: 1/2" NPS-M



Elite Folding Tap Arc Spout



OEM #	Aftermarket #	Finish
132-1729-CP	--	Chrome

- Spout rotates 180° front/back and swivels 180° side/side
- All brass body and spout with metal handle
- Ceramic disc valve
- Single hole mount, 3/4" - 1" Ø
- Connection: 1/2" NPS-M

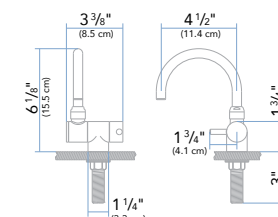

AIDACK™ SERIES



Elite Folding Tap Arc Spout



OEM #	Aftermarket #	Finish
132-0229-CP	--	Chrome

- Spout rotates 180° front/back and swivels 180° side/side
- All brass body and spout with metal handle
- Ceramic disc valve
- Single hole mount, 3/4" - 1" Ø
- Connection: 1/2" NPS-M

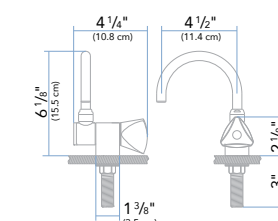

TRINIDAD™ SERIES



Elite Folding Tap Angled Spout



OEM #	Aftermarket #	Finish
132-1739-CP	--	Chrome

- Spout rotates 180° front/back and swivels 180° side/side
- All brass body and spout with metal handle
- Ceramic disc valve
- Single hole mount, 3/4" - 1" Ø
- Connection: 1/2" NPS-M

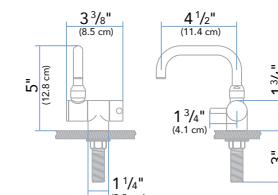

AIDACK™ SERIES



Elite Folding Tap Angled Spout



OEM #	Aftermarket #	Finish
132-0239-CP	--	Chrome

- Spout rotates 180° front/back and swivels 180° side/side
- All brass body and spout with metal handle
- Ceramic disc valve
- Single hole mount, 3/4" - 1" Ø
- Connection: 1/2" NPS-M

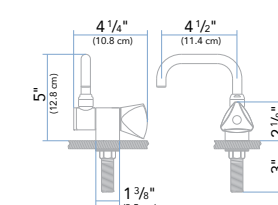

TRINIDAD™ SERIES



Elite Folding Faucet J-Spout

- Spout rotates 180° front/back and swivels 180° side/side
- All brass body and spout with metal handle
- Flexible stainless steel braided supply line hoses
- Ceramic disc valve
- Single hole mount, 1" Ø
- Connections: 1/2" NPS-M

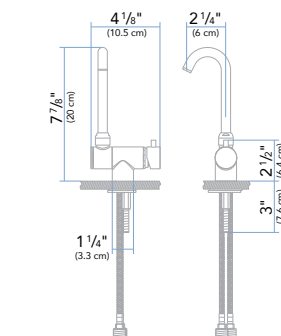

AIDACK™ SERIES

OEM #	Aftermarket #	Finish
132-1725-CP	--	Chrome



Elite Folding Faucet J-Spout

- Spout rotates 180° front/back and swivels 180° side/side
- All brass body and ribbon spout with metal handle
- Flexible stainless steel braided supply line hoses
- Ceramic disc valve
- Single hole mount, 1" Ø
- Connections: 1/2" NPS-M

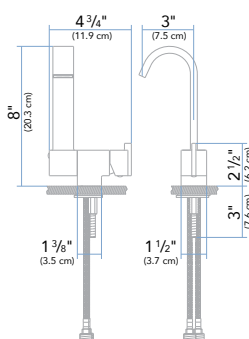

ARTAINE™ SERIES

OEM #	Aftermarket #	Finish
132-2025-CP	--	Chrome
132-2025-NP	--	Brushed Nickel



Elite Folding Faucet J-Spout

- Spout rotates 180° front/back and swivels 180° side/side
- All brass body and spout with metal handles
- Ceramic disc valves
- Two hole mount, 3/4" - 1" Ø (2 1/2" - 2 3/4" CC)
- Connections: 1/2" NPS-M

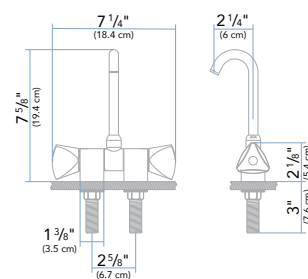

TRINIDAD™ SERIES

OEM #	Aftermarket #	Finish
--	133-0210-CP	Chrome



EDGEWATER 200CC
FEATURING DECK-MOUNT SPRAYER# 134-0009-CP

OEM # - Not Labeled Or Packaged For Resale Aftermarket # - Labeled And Packaged For Resale NOTE: Dimension Drawings ±1/16" (for reference only - may not be to scale)



Elite Folding Faucet Arc Spout

- Spout rotates 180° front/back and swivels 180° side/side
- All brass body and spout with metal handle
- Flexible stainless steel braided supply line hoses
- Ceramic disc valve
- Single hole mount, 1" Ø
- Connections: 1/2" NPS-M

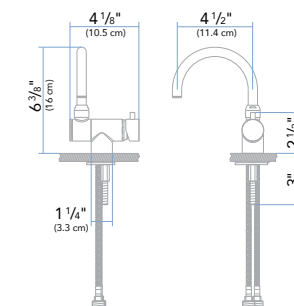

AIDACK™ SERIES

OEM #	Aftermarket #	Finish
132-1726-CP	--	Chrome



Elite Folding Faucet Arc Spout

- Spout rotates 180° front/back and swivels 180° side/side
- All brass body and spout with metal handles
- Ceramic disc valves
- Two hole mount, 3/4" - 1" Ø (2 1/2" - 2 3/4" CC)
- Connections: 1/2" NPS-M

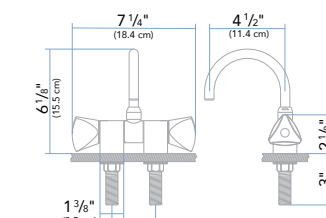

TRINIDAD™ SERIES

OEM #	Aftermarket #	Finish
132-0230-CP	--	Chrome



Elite Folding Faucet Angled Spout

- Spout rotates 180° front/back and swivels 180° side/side
- All brass body and spout with metal handle
- Flexible stainless steel braided supply line hoses
- Ceramic disc valve
- Single hole mount, 1" Ø
- Connections: 1/2" NPS-M

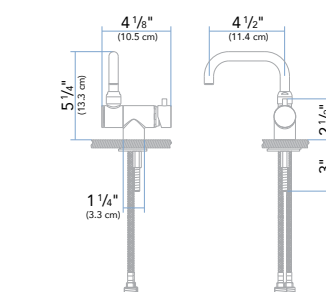

AIDACK™ SERIES

OEM #	Aftermarket #	Finish
132-1727-CP	--	Chrome



Elite Folding Faucet Angled Spout

- Spout rotates 180° front/back and swivels 180° side/side
- All brass body and spout with metal handles
- Ceramic disc valves
- Two hole mount, 3/4" - 1" Ø (2 1/2" - 2 3/4" CC)
- Connections: 1/2" NPS-M

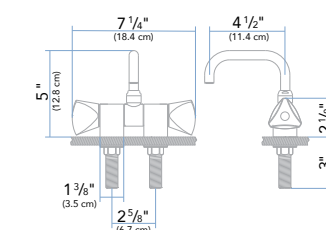

TRINIDAD™ SERIES

OEM #	Aftermarket #	Finish
132-0240-CP	--	Chrome

OEM # - Not Labeled Or Packaged For Resale Aftermarket # - Labeled And Packaged For Resale NOTE: Dimension Drawings ±1/16" (for reference only - may not be to scale)

PULL-OUT TAPS COLD ONLY

MARINE GRADE



Pull-Out Deck Tap

AIDACK™ / CLASSIC SPRAYER SERIES

	OEM #	Aftermarket #	Body Finish	Sprayer Finish	Hose Length	Hose Type
<ul style="list-style-type: none"> 2-function spray/aerated stream with water conserving "stand-by" button (NOTE: "stand-by" is NOT a complete water shut-off, it allows a small amount of water to continue to trickle) Heavy duty, UV protected, ABS plastic and chrome plated brass sprayer Heavy duty pull-out hose All brass body with locking teeth and metal handle Flexible stainless steel braided supply line hose Ceramic disc valve Two hole mount, 1" Ø (1" - 1 1/8" CC) Connection: 1/2" NPS-M 	134-1712-CA	--	Chrome	Arctic White & Chrome w/Locking Teeth	6' (1.8m)	White Rubber
	134-1735-CA	--	Chrome	Arctic White & Chrome w/Locking Teeth	10' (3m)	White Rubber
	134-1734-CA	--	Chrome	Arctic White & Chrome w/Locking Teeth	6' (1.8m)	Stainless Steel
	134-1712-CW	--	Chrome	Warm White & Chrome w/Locking Teeth	6' (1.8m)	White Rubber
	134-1735-CW	--	Chrome	Warm White & Chrome w/Locking Teeth	10' (3m)	White Rubber
	134-1734-CW	--	Chrome	Warm White & Chrome w/Locking Teeth	6' (1.8m)	Stainless Steel
	134-1712-CK	--	Chrome	Black & Chrome w/Locking Teeth	6' (1.8m)	Black Rubber
	134-1734-CK	--	Chrome	Black & Chrome w/Locking Teeth	6' (1.8m)	Stainless Steel

"Locking Teeth" prevent sprayer from rotating while in faucet body or bulkhead holder

Bulkhead Sprayer Holder
with Ambassador Marine's unique LOCKING TEETH
sold separately (see page 39)



Pull-Out Deck Tap

AIDACK™ / SMALL SPRAYER SERIES

	OEM #	Aftermarket #	Body Finish	Sprayer Finish	Hose Length	Hose Type
<ul style="list-style-type: none"> Heavy duty, UV protected, ABS plastic and chrome plated brass sprayer Complete water shut-off when trigger is not engaged Depressing trigger allows for intermittent water flow - lifting trigger locks it on for continuous water flow Heavy duty pull-out hose All brass body with locking teeth and metal handle Flexible stainless steel braided supply line hose Ceramic disc valve Two hole mount, 1" Ø (1" - 1 1/8" CC) Connection: 1/2" NPS-M 	134-1720-CA	--	Chrome	Arctic White & Chrome w/Locking Teeth	6' (1.8m)	White Rubber
	134-1748-CA	--	Chrome	Arctic White & Chrome w/Locking Teeth	10' (3m)	White Rubber
	134-1736-CA	--	Chrome	Arctic White & Chrome w/Locking Teeth	6' (1.8m)	Stainless Steel
	134-1720-CW	--	Chrome	Warm White & Chrome w/Locking Teeth	6' (1.8m)	White Rubber
	134-1748-CW	--	Chrome	Warm White & Chrome w/Locking Teeth	10' (3m)	White Rubber
	134-1736-CW	--	Chrome	Warm White & Chrome w/Locking Teeth	6' (1.8m)	Stainless Steel
	134-1720-CP	--	Chrome	Chrome w/Locking Teeth	6' (1.8m)	Black Rubber
	134-1736-CP	--	Chrome	Chrome w/Locking Teeth	6' (1.8m)	Stainless Steel
	134-1720-CK	--	Chrome	Black & Chrome w/Locking Teeth	6' (1.8m)	Black Rubber
	134-1736-CK	--	Chrome	Black & Chrome w/Locking Teeth	6' (1.8m)	Stainless Steel

"Locking Teeth" prevent sprayer from rotating while in faucet body or bulkhead holder

Bulkhead Sprayer Holder
with Ambassador Marine's unique LOCKING TEETH
sold separately (see page 39)



MARINE GRADE

COLD ONLY PULL-OUT TAPS



Pull-Out Deck Tap

AIDACK™ / KITCHEN SPRAYER SERIES

	OEM #	Aftermarket #	Body Finish	Sprayer Finish	Hose Length	Hose Type
<ul style="list-style-type: none"> 2-function spray/aerated stream Heavy duty, UV protected, ABS plastic and chrome plated brass sprayer Heavy duty pull-out hose All brass body with locking teeth and metal handle Flexible stainless steel braided supply line hose Ceramic disc valve Two hole mount, 1" Ø (1" - 1 1/8" CC) Connection: 1/2" NPS-M 	134-1777-CW	--	Chrome	Chrome w/Locking Teeth	6' (1.8m)	White Rubber
	134-1777-CP	--	Chrome	Chrome w/Locking Teeth	6' (1.8m)	Black Rubber
	134-1779-CW	--	Chrome	Chrome w/Locking Teeth	10' (3m)	White Rubber
	134-1778-CW	--	Chrome	Chrome w/Locking Teeth	6' (1.8m)	Stainless Steel

"Locking Teeth" prevent sprayer from rotating while in faucet body or bulkhead holder

Bulkhead Sprayer Holder
with Ambassador Marine's unique LOCKING TEETH
sold separately (see page 39)



Pull-Out Deck Tap

AIDACK™ / LARGE SPRAYER SERIES

	OEM #	Aftermarket #	Body Finish	Sprayer Finish	Hose Length	Hose Type
<ul style="list-style-type: none"> Heavy duty, UV protected, ABS plastic and chrome plated brass sprayer Complete water shut-off when trigger is not engaged Depressing trigger allows for intermittent water flow - lifting trigger locks it on for continuous water flow Heavy duty pull-out hose All brass body with locking teeth and metal handle Flexible stainless steel braided supply line hose Ceramic disc valve Two hole mount, 1" Ø (1" - 1 1/8" CC) Connection: 1/2" NPS-M 	134-1759-CW∞	--	Chrome	Warm White & Chrome w/Locking Teeth	6' (1.8m)	White Rubber
	134-1761-CW∞	--	Chrome	Warm White & Chrome w/Locking Teeth	10' (3m)	White Rubber
	134-1760-CW∞	--	Chrome	Warm White & Chrome w/Locking Teeth	6' (1.8m)	Stainless Steel
	134-1759-CP∞	--	Chrome	Chrome w/Locking Teeth	6' (1.8m)	Black Rubber
	134-1760-CP∞	--	Chrome	Chrome w/Locking Teeth	6' (1.8m)	Stainless Steel
	134-1759-CK∞	--	Chrome	Black & Chrome w/Locking Teeth	6' (1.8m)	Black Rubber
	134-1760-CK∞	--	Chrome	Black & Chrome w/Locking Teeth	6' (1.8m)	Stainless Steel

"Locking Teeth" prevent sprayer from rotating while in faucet body or bulkhead holder

Bulkhead Sprayer Holder
with Ambassador Marine's unique LOCKING TEETH
sold separately (see page 39)



PULL-OUT FAUCETS HOT/COLD MARINE GRADE



Head/Shower Combo Faucet TRINIDAD™ / CLASSIC SPRAYER SERIES

	OEM #	Aftermarket #	Body Finish	Sprayer Finish	Hose Length	Hose Type
• 2-function spray/aerated stream with water conserving "stand-by" button (NOTE: "stand-by" is NOT a complete water shut-off, it allows a small amount of water to continue to trickle)	134-0204-CA	--	Chrome	Arctic White & Chrome w/Locking Teeth	6' (1.8m)	White Rubber
	134-0262-CA	--	Chrome	Arctic White & Chrome w/Locking Teeth	10' (3m)	White Rubber
• Heavy duty, UV protected, ABS plastic and chrome plated brass sprayer	134-0224-CA	--	Chrome	Arctic White & Chrome w/Locking Teeth	6' (1.8m)	Stainless Steel
	134-0204-CW	135-0204-CW	Chrome	Warm White & Chrome w/Locking Teeth	6' (1.8m)	White Rubber
• Heavy duty pull-out hose	134-0262-CW	--	Chrome	Warm White & Chrome w/Locking Teeth	10' (3m)	White Rubber
	134-0224-CW	--	Chrome	Warm White & Chrome w/Locking Teeth	6' (1.8m)	Stainless Steel
• All brass body with locking teeth and metal handles	134-0263-CW [∞]	--	Chrome	Warm White & Chrome NO Locking Teeth	6' (1.8m)	White Rubber
	134-0264-CW [∞]	--	Chrome	Warm White & Chrome NO Locking Teeth	10' (3m)	White Rubber
• Flexible stainless steel braided supply line hoses	134-0230-CW [∞]	--	Chrome	Warm White & Chrome NO Locking Teeth	6' (1.8m)	Stainless Steel
	134-0204-CK	--	Chrome	Black & Chrome w/Locking Teeth	6' (1.8m)	Black Rubber
• Ceramic disc valves	134-0224-CK	--	Chrome	Black & Chrome w/Locking Teeth	6' (1.8m)	Stainless Steel
	134-0263-CK [∞]	--	Chrome	Black & Chrome NO Locking Teeth	6' (1.8m)	Black Rubber
• Single hole mount, 1 1/4" Ø	134-0230-CK [∞]	--	Chrome	Black & Chrome NO Locking Teeth	6' (1.8m)	Stainless Steel
	134-0230-CK [∞]	--	Chrome	Black & Chrome NO Locking Teeth	6' (1.8m)	Stainless Steel

"Locking Teeth" prevent sprayer from rotating while in faucet body or bulkhead holder

Bulkhead Sprayer Holder
with Ambassador Marine's unique LOCKING TEETH
sold separately (see page 39)



Head/Shower Combo Faucet TRINIDAD™ / SMALL SPRAYER SERIES

	OEM #	Aftermarket #	Body Finish	Sprayer Finish	Hose Length	Hose Type
• Heavy duty, UV protected, ABS plastic and chrome plated brass sprayer	134-0213-CA	--	Chrome	Arctic White & Chrome w/Locking Teeth	6' (1.8m)	White Rubber
	134-0266-CA	--	Chrome	Arctic White & Chrome w/Locking Teeth	10' (3m)	White Rubber
• Complete water shut-off when trigger is not engaged	134-0265-CA	--	Chrome	Arctic White & Chrome w/Locking Teeth	6' (1.8m)	Stainless Steel
	134-0213-CW	--	Chrome	Warm White & Chrome w/Locking Teeth	6' (1.8m)	White Rubber
• Depressing trigger allows for intermittent water flow – lifting trigger locks it on for continuous water flow	134-0266-CW	--	Chrome	Warm White & Chrome w/Locking Teeth	10' (3m)	White Rubber
	134-0265-CW	--	Chrome	Warm White & Chrome w/Locking Teeth	6' (1.8m)	Stainless Steel
• Heavy duty pull-out hose	134-0213-CP	--	Chrome	Chrome w/Locking Teeth	6' (1.8m)	Black Rubber
	134-0265-CP	--	Chrome	Chrome w/Locking Teeth	6' (1.8m)	Stainless Steel
• All brass body with locking teeth and metal handles	134-0213-CK	--	Chrome	Black & Chrome w/Locking Teeth	6' (1.8m)	Black Rubber
	134-0265-CK	--	Chrome	Black & Chrome w/Locking Teeth	6' (1.8m)	Stainless Steel

"Locking Teeth" prevent sprayer from rotating while in faucet body or bulkhead holder

Bulkhead Sprayer Holder
with Ambassador Marine's unique LOCKING TEETH
sold separately (see page 39)



MARINE GRADE HOT/COLD PULL-OUT FAUCETS



Head/Shower Combo Faucet TRINIDAD™ / KITCHEN SPRAYER SERIES

	OEM #	Aftermarket #	Body Finish	Sprayer Finish	Hose Length	Hose Type
• 2-function spray/aerated stream	134-0227-CW	--	Chrome	Chrome w/Locking Teeth	6' (1.8m)	White Rubber
	134-0227-CP	--	Chrome	Chrome w/Locking Teeth	6' (1.8m)	Black Rubber
• Heavy duty, UV protected, ABS plastic and chrome plated brass sprayer	134-0229-CW	--	Chrome	Chrome w/Locking Teeth	10' (3m)	White Rubber
	134-0228-CP	--	Chrome	Chrome w/Locking Teeth	6' (1.8m)	Stainless Steel

"Locking Teeth" prevent sprayer from rotating while in faucet body or bulkhead holder

Bulkhead Sprayer Holder
with Ambassador Marine's unique LOCKING TEETH
sold separately (see page 39)



- Flexible stainless steel braided supply line hoses
- Ceramic disc valves
- Single hole mount, 1 1/4" Ø
- Connections: 1/2" NPS-M



Head/Shower Combo Faucet TRINIDAD™ / LARGE SPRAYER SERIES

	OEM #	Aftermarket #	Body Finish	Sprayer Finish	Hose Length	Hose Type
• Heavy duty, UV protected, ABS plastic and chrome plated brass sprayer	134-0215-CW [∞]	--	Chrome	Warm White & Chrome w/Locking Teeth	6' (1.8m)	White Rubber
	134-0268-CW [∞]	--	Chrome	Warm White & Chrome w/Locking Teeth	10' (3m)	White Rubber
• Complete water shut-off when trigger is not engaged	134-0267-CW [∞]	--	Chrome	Warm White & Chrome w/Locking Teeth	6' (1.8m)	Stainless Steel
	134-0215-CP [∞]	--	Chrome	Chrome w/Locking Teeth	6' (1.8m)	Black Rubber
• Depressing trigger allows for intermittent water flow – lifting trigger locks it on for continuous water flow	134-0267-CP [∞]	--	Chrome	Chrome w/Locking Teeth	6' (1.8m)	Stainless Steel
	134-0215-CK [∞]	--	Chrome	Black & Chrome w/Locking Teeth	6' (1.8m)	Black Rubber
• Heavy duty pull-out hose	134-0267-CK [∞]	--	Chrome	Black & Chrome w/Locking Teeth	6' (1.8m)	Stainless Steel

"Locking Teeth" prevent sprayer from rotating while in faucet body or bulkhead holder

Bulkhead Sprayer Holder
with Ambassador Marine's unique LOCKING TEETH
sold separately (see page 39)



- Flexible stainless steel braided supply line hoses
- Ceramic disc valves
- Single hole mount, 1 1/4" Ø
- Connections: 1/2" NPS-M

PULL-OUT FAUCETS HOT/COLD MARINE GRADE

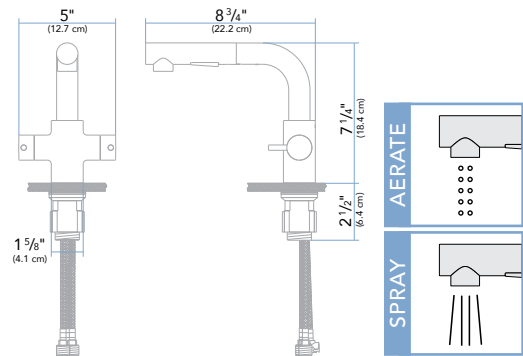

Pull-Out Galley Faucet

- 2-function spray/aerated stream pull-out slim wand sprayer
- Heavy duty pull-out hose with retraction and quick-connect fitting
- All brass body and high arc swivel spout with metal handles
- Flexible stainless steel braided supply line hoses
- Ceramic disc valves
- Easy-Grip mounting hardware
- Single hole mount, 1 1/4" Ø
- Connections: 1/2" NPS-M

OEM #	Aftermarket #	Finish	Sprayer Type	Hose Length	Hose Type
--	133-1734-CP	Chrome	2-Function	6' (1.8m)	Stainless Steel
132-1735-CP	--	Chrome	2-Function	10' (3m)	Stainless Steel

AIDACK™ SERIES

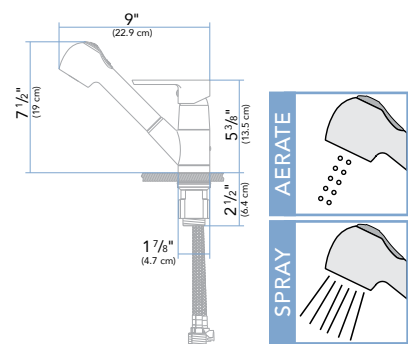

Pull-Out Galley Faucet

- 2-function spray/aerated stream pull-out sprayer
- Heavy duty pull-out hose with retraction and quick-connect fitting
- Swivel spout
- Flexible stainless steel braided supply line hoses
- Ceramic disc valve
- Easy-Grip mounting hardware
- Single hole mount, 1 1/4" Ø
- Connections: 1/2" NPS-M

OEM #	Aftermarket #	Finish	Sprayer Type	Hose Length	Hose Type
132-2112-CP	--	Chrome	2-Function	4' (1.2m)	Stainless Steel
132-2112-NP	--	Brushed Nickel	2-Function	4' (1.2m)	Stainless Steel

IRVA™ SERIES

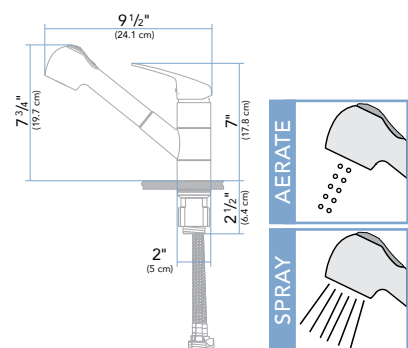

Pull-Out Galley Faucet

- 2-function spray/aerated stream pull-out sprayer
- Heavy duty pull-out hose with retraction and quick-connect fitting
- Swivel spout
- Flexible stainless steel braided supply line hoses
- Ceramic disc valve
- Single hole mount, 1 1/4" Ø
- Connections: 1/2" NPS-M

OEM #	Aftermarket #	Finish	Sprayer Type	Hose Length	Hose Type
132-1003-NP	--	Brushed Nickel	2-Function	4' (1.2m)	Stainless Steel

NAUTILUS™ SERIES

Built-In Soap Dispensers

sold separately (see page 31)



MARINE GRADE HOT/COLD PULL-OUT FAUCETS

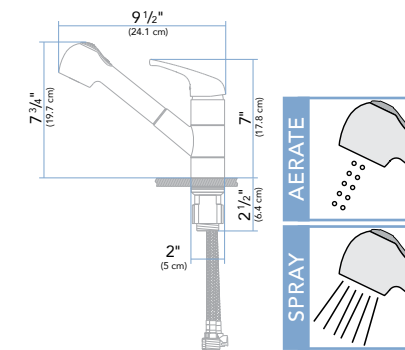

Pull-Out Galley Faucet

- 2-function spray/aerated stream pull-out sprayer
- Heavy duty pull-out hose with retraction and quick-connect fitting
- Swivel spout
- Flexible stainless steel braided supply line hoses
- Ceramic disc valve
- Easy-Grip mounting hardware
- Single hole mount, 1 1/4" Ø
- Connections: 1/2" NPS-M

OEM #	Aftermarket #	Finish	Sprayer Type	Hose Length	Hose Type
132-0003-CP	--	Chrome	2-Function	4' (1.2m)	Stainless Steel
132-0031-CP	--	Chrome	2-Function	6' (1.8m)	Stainless Steel
132-0003-NP	--	Brushed Nickel	2-Function	4' (1.2m)	Stainless Steel
132-0031-NP	--	Brushed Nickel	2-Function	6' (1.8m)	Stainless Steel

PACIFICA™ (UNIVERSAL) SERIES

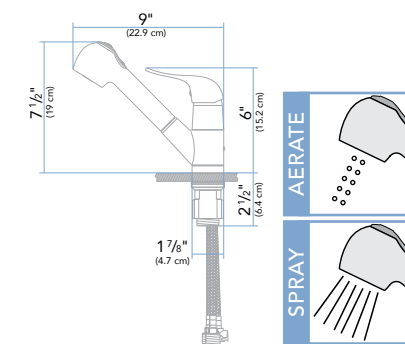

Pull-Out Galley Faucet

- 2-function spray/aerated stream pull-out sprayer
- Heavy duty pull-out hose with retraction and quick-connect fitting
- Swivel spout
- Flexible stainless steel braided supply line hoses
- Ceramic disc valve
- Easy-Grip mounting hardware
- Single hole mount, 1 1/4" Ø
- Connections: 1/2" NPS-M

OEM #	Aftermarket #	Finish	Sprayer Type	Hose Length	Hose Type
--	133-0112-CP	Chrome	2-Function	4' (1.2m)	Stainless Steel

STASIS™ SERIES

Built-In Soap Dispensers

sold separately (see page 31)



CROWLINE E285
FEATURING AIDACK™ ELITE FOLDING TAP# 132-1729-CP
& STAINLESS STEEL SINK# S14-2500-BR

GALLEY FAUCETS HOT/COLD

MARINE GRADE



Galley Faucet

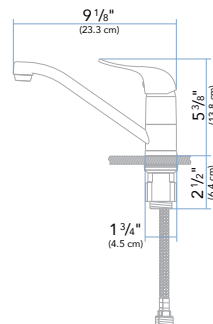

STASIS™ SERIES

OEM #	Aftermarket #	Finish
132-0101-CP	--	Chrome

- All brass body and swivel spout with metal handle
- Flexible stainless steel braided supply line hoses
- Ceramic disc valve
- Easy-Grip mounting hardware
- Single hole mount, 1 1/4" Ø
- Connections: 1/2" NPS-M



Galley Faucet High Arc Spout

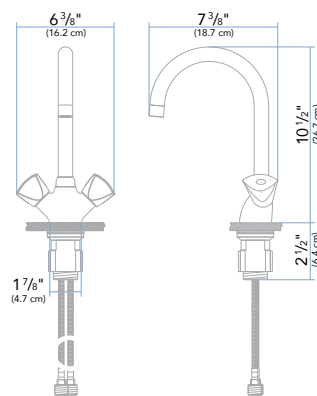

TRINIDAD™ SERIES

OEM #	Aftermarket #	Finish
--	133-0202-CP	Chrome

- All brass body and swivel spout with metal handles
- Flexible stainless steel braided supply line hoses
- Ceramic disc valves
- Easy-Grip mounting hardware
- Single hole mount, 1 1/4" Ø
- Connections: 1/2" NPS-M



Galley Faucet Cast Spout

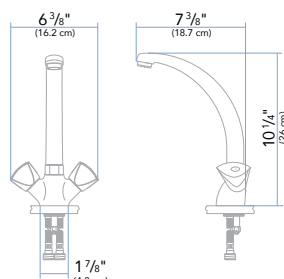

TRINIDAD™ SERIES

OEM #	Aftermarket #	Finish
132-0205-CP≈	--	Chrome
132-0205-CG∞	--	Chrome & 18k Gold

- All brass body and cast swivel spout with metal handles
- Flexible stainless steel braided supply line hoses
- Ceramic disc valves
- Single hole mount, 1 1/4" Ø
- Connections: 1/2" NPS-M

Built-In Soap Dispensers

sold separately (see page 31)



MARINE GRADE

GALLEY ACCESSORIES



Built-In Soap Dispenser

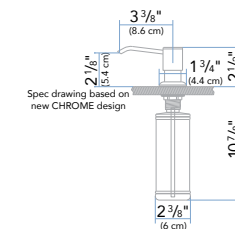

- Lift-out nozzle and pump allows for easy refilling from above counter
- Heavy duty pump and nozzle for thicker soaps / lotions
- All brass nozzle and housing
- Clear plastic bottle for easy fill monitoring
- Single hole mount, 1" - 1 1/4" Ø

OEM #	Aftermarket #	Finish
130-0011-CP	--	Chrome
130-0011-NP≈	--	Brushed Nickel

MARINE GRADE

COLD ONLY TAPS



Galley Tap High Arc Spout

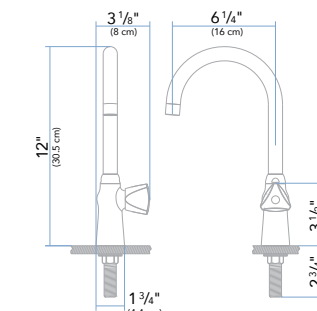

TRINIDAD™ SERIES

OEM #	Aftermarket #	Finish
132-0206-CP	133-0206-CP	Chrome

- All cast brass body with brass spout and metal handle
- High arc swivel spout
- Ceramic disc valve
- Single hole mount, 3/4" - 1" Ø
- Connection: 1/2" NPS-M



Deck Tap

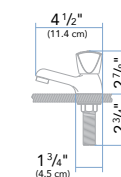

TRINIDAD™ SERIES

OEM #	Aftermarket #	Finish
--	133-0211-CP	Chrome

- All cast brass body with metal handle
- Ceramic disc valve
- Single hole mount, 3/4" - 1" Ø
- Connection: 1/2" NPS-M



PREMIER PONTOONS ESCALANTE
FEATURING TRINIDAD™ GALLEY TAP# 132-0206-CP

OEM # - Not Labeled Or Packaged For Resale Aftermarket # - Labeled And Packaged For Resale NOTE: Dimension Drawings ±1/16" (for reference only - may not be to scale) ≈ To Be Refreshed/Replaced When Inventory Is Depleted ∞ To Be Refreshed/Replaced When Inventory Is Depleted

HEAD FAUCETS HOT/COLD

MARINE GRADE

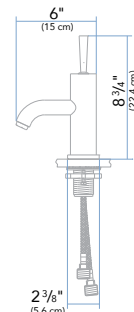

Head Faucet

- "Joystick" control
- All brass body and spout with metal handle
- Flexible stainless steel braided supply line hoses
- Ceramic disc valve
- Single hole mount, 1 1/4" Ø
- Connections: 1/2" NPS-M

OEM #	Aftermarket #	Finish
132-0600-CP [∞]	--	Chrome

ALLURE™ SERIES

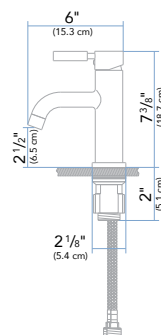

Head Faucet

- All brass body and spout with metal handle
- Flexible stainless steel braided supply line hoses
- Ceramic disc valve
- Single hole mount, 1 1/4" Ø
- Connections: 1/2" NPS-M

OEM #	Aftermarket #	Finish
132-0700-CP	--	Chrome

AVIANI™ SERIES

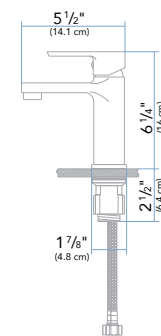

Head Faucet

- All brass body with metal handle
- Flexible stainless steel braided supply line hoses
- Ceramic disc valve
- Single hole mount, 1 1/4" Ø
- Connections: 1/2" NPS-F

OEM #	Aftermarket #	Finish
132-2100-CP	--	Chrome
132-2100-NP	--	Brushed Nickel

IRVA™ SERIES

MARINE GRADE

HOT/COLD HEAD FAUCETS



Head Faucet

- All brass body with metal handle
- Flexible stainless steel braided supply line hoses
- Ceramic disc valve
- Single hole mount, 1 1/4" Ø
- Connections: 1/2" NPS-M

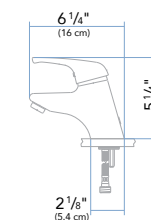

PACIFICA™ (UNIVERSAL) SERIES

OEM #	Aftermarket #	Finish
132-0800-CP [≈]	--	Chrome
132-0800-CG [∞]	--	Chrome & 18k Gold



Head Faucet

- All brass body with metal handle
- Flexible stainless steel braided supply line hoses
- Ceramic disc valve
- Single hole mount, 1 1/4" Ø
- Connections: 1/2" NPS-M

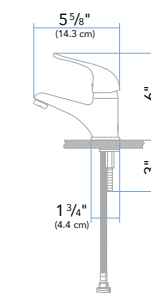

STASIS™ SERIES

OEM #	Aftermarket #	Finish
132-0100-CP [≈]	133-0100-CP [≈]	Chrome

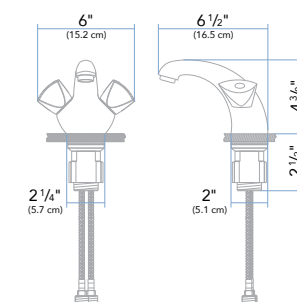

Head Faucet

- All brass body with metal handles
- Flexible stainless steel braided supply line hoses
- Ceramic disc valves
- Easy-Grip mounting hardware
- Single hole mount, 1 1/4" Ø
- Connections: 1/2" NPS-M

OEM #	Aftermarket #	Finish
--	133-0207-CP	Chrome

TRINIDAD™ SERIES

WALL-MOUNT FAUCETS HOT/COLD MARINE GRADE

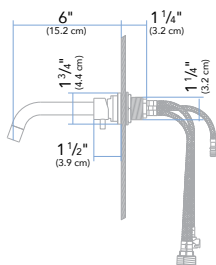

Wall-Mount Faucet

AIDACK™ SERIES

- Specifically designed for thin (fiberglass) walls
- Control valve can be installed on left or right side of spout with variable spacing
- Easy installation – mounts directly to bulkhead (no strapping required)
- All brass body and spout with metal handle
- Flexible stainless steel braided supply lines and valve-to-spout connector hose with quick-connect
- Ceramic disc valve
- Two-hole mount, 1 1/4" Ø (or 1 1/4" Ø + 3/4" - 1" Ø)
- Connections: 1/2" NPS-M

OEM #	Aftermarket #	Finish
132-1724-CP	--	Chrome

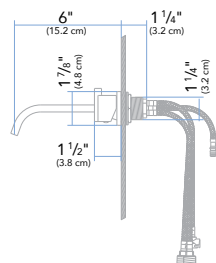

Wall-Mount Faucet

ARTAINÉ™ SERIES

- Specifically designed for thin (fiberglass) walls
- Control valve can be installed on left or right side of spout with variable spacing
- Easy installation – mounts directly to bulkhead (no strapping required)
- All brass body and ribbon spout with metal handle
- Flexible stainless steel braided supply lines and valve-to-spout connector hose with quick-connect
- Ceramic disc valve
- Two-hole mount, 1 1/4" Ø (or 1 1/4" Ø + 3/4" - 1" Ø)
- Connections: 1/2" NPS-M

OEM #	Aftermarket #	Finish
132-2024-CP	--	Chrome
132-2024-NP	--	Brushed Nickel

VESSEL FAUCETS HOT/COLD MARINE GRADE

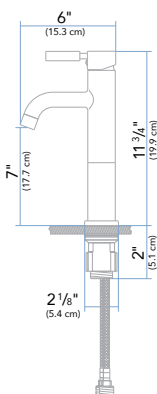

Vessel Faucet

AVIANI™ SERIES

- Sized specifically to fit Ambassador Marine's vessel sinks
- All brass body and spout with metal handle
- Flexible stainless steel braided supply line hoses
- Ceramic disc valve
- Single hole mount, 1 1/4" Ø
- Connections: 1/2" NPS-M

OEM #	Aftermarket #	Finish
132-0723-CP	--	Chrome

OEM # – Not Labeled Or Packaged For Resale Aftermarket # – Labeled And Packaged For Resale NOTE: Dimension Drawings ±1/16" (for reference only – may not be to scale)

MARINE GRADE HOT/COLD MINI SHOWER MIXERS

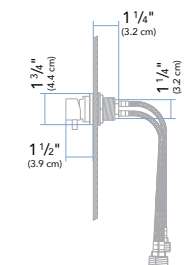

Mini Shower Mixer Thin Wall / Fiberglass Mount

AIDACK™ SERIES

- Wall or deck mounting option
- Designed for thin (fiberglass) walls/surfaces
- All brass valve body with metal handle
- Flexible stainless steel braided supply line hoses
- Ceramic disc valve
- Easy installation – mounts directly to bulkhead/deck (no strapping required)
- Single hole mount, 1 1/4" Ø
- Connections: 1/2" NPS-M

OEM #	Aftermarket #	Finish
136-1706-CP	--	Chrome

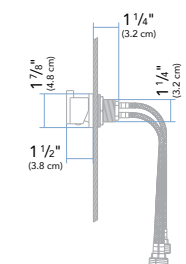

Mini Shower Mixer Thin Wall / Fiberglass Mount

ARTAINÉ™ SERIES

- Wall or deck mounting option
- Designed for thin (fiberglass) walls/surfaces
- All brass valve body with metal handle
- Flexible stainless steel braided supply line hoses
- Ceramic disc valve
- Easy installation – mounts directly to bulkhead/deck (no strapping required)
- Single hole mount, 1 1/4" Ø
- Connections: 1/2" NPS-M

OEM #	Aftermarket #	Finish
136-2006-CP	--	Chrome
136-2006-NP	--	Brushed Nickel

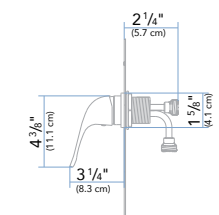

Mini Shower Mixer Thin Wall / Fiberglass Mount

STASIS™ SERIES

- Wall or deck mounting option
- Designed for thin (fiberglass) walls/surfaces
- All brass valve body with metal handle
- Ceramic disc valve
- Easy installation – mounts directly to bulkhead/deck (no strapping required)
- Single hole mount, 1 1/4" Ø
- Connections: 1/2" NPS-M

OEM #	Aftermarket #	Finish
136-0106-CP≈	--	Chrome

OEM # – Not Labeled Or Packaged For Resale Aftermarket # – Labeled And Packaged For Resale NOTE: Dimension Drawings ±1/16" (for reference only – may not be to scale)
≈ To Be Refreshed/Replaced When Inventory Is Depleted

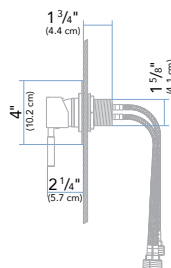

Shower Mixer Thin Wall / Fiberglass Mount

- Wall or deck mounting option
- Designed for thin (fiberglass) walls/surfaces
- All brass valve body and trim plate with metal handle
- Flexible stainless steel braided supply line hoses
- Ceramic disc valve
- Easy installation – mounts directly to bulkhead/deck (no strapping required)
- Single hole mount, 1 3/4" - 2" Ø
- Connections: 1/2" NPS-M

OEM #	Aftermarket #	Finish
134-0732-CP	--	Chrome

AVIANI™ SERIES

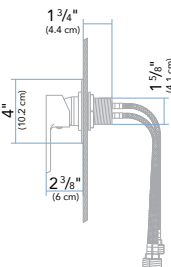

Shower Mixer Thin Wall / Fiberglass Mount

- Wall or deck mounting option
- Designed for thin (fiberglass) walls/surfaces
- All brass valve body and trim plate with metal handle
- Flexible stainless steel braided supply line hoses
- Ceramic disc valve
- Easy installation – mounts directly to bulkhead/deck (no strapping required)
- Single hole mount, 1 3/4" - 2" Ø
- Connections: 1/2" NPS-M

OEM #	Aftermarket #	Finish
134-2132-CP	--	Chrome
134-2132-NP	--	Brushed Nickel

IRVA™ SERIES

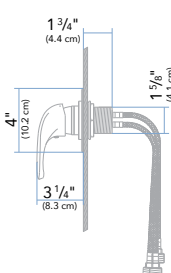

Shower Mixer Thin Wall / Fiberglass Mount

- Wall or deck mounting option
- Designed for thin (fiberglass) walls/surfaces
- All brass valve body and trim plate with metal handle
- Flexible stainless steel braided supply line hoses
- Ceramic disc valve
- Easy installation – mounts directly to bulkhead/deck (no strapping required)
- Single hole mount, 1 3/4" - 2" Ø
- Connections: 1/2" NPS-M

OEM #	Aftermarket #	Finish
134-0832-CP	--	Chrome

PACIFICA™ (UNIVERSAL) SERIES

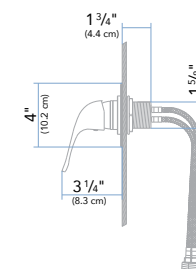

Shower Mixer Thin Wall / Fiberglass Mount

- Wall or deck mounting option
- Designed for thin (fiberglass) walls/surfaces
- All brass valve body and trim plate with metal handle
- Flexible stainless steel braided supply line hoses
- Ceramic disc valve
- Easy installation – mounts directly to bulkhead/deck (no strapping required)
- Single hole mount, 1 3/4" - 2" Ø
- Connections: 1/2" NPS-M

OEM #	Aftermarket #	Finish
134-0132-CP	135-0132-CP	Chrome

STASIS™ SERIES



External Shower Mixer Thin Wall / Fiberglass Mount

- Heavy duty, UV protected, ABS plastic sprayer
- Complete water shut-off when trigger is not engaged
- Depressing trigger allows for intermittent water flow – lifting trigger locks it on for continuous water flow
- Heavy duty hose
- ABS plastic 2-position bulkhead sprayer holder
- Designed for thin (fiberglass) walls/surfaces
- All brass body with metal handles
- Compression valves
- Easy installation – mounts directly to bulkhead (no strapping required)
- Two hole mount, 1" Ø (4" CC)
- Connections: 1/2" NPS-M

OEM #	Aftermarket #	Body Finish	Sprayer Finish	Hose Length	Hose Type
134-0214-CA	--	Chrome	Arctic White	6' (1.8m)	White Rubber
134-0217-CA	--	Chrome	Arctic White	10' (3m)	White Rubber
134-0207-CA	--	Chrome	Arctic White	6' (1.8m)	Stainless Steel
134-0214-CW	--	Chrome	Warm White	6' (1.8m)	White Rubber
134-0217-CW	--	Chrome	Warm White	10' (3m)	White Rubber
134-0207-CW	--	Chrome	Warm White	6' (1.8m)	Stainless Steel
134-0214-CP	--	Chrome	Chrome	6' (1.8m)	Black Rubber
134-0207-CP	--	Chrome	Chrome	6' (1.8m)	Stainless Steel
134-0214-CK	--	Chrome	Black	6' (1.8m)	Black Rubber
134-0207-CK	--	Chrome	Black	6' (1.8m)	Stainless Steel

TRINIDAD™ SERIES



SOLACE 32 CS
FEATURING AIDACK™ PULL-OUT DECK TAP# 134-1734-CK

HAND-HELD SHOWERS

MARINE GRADE

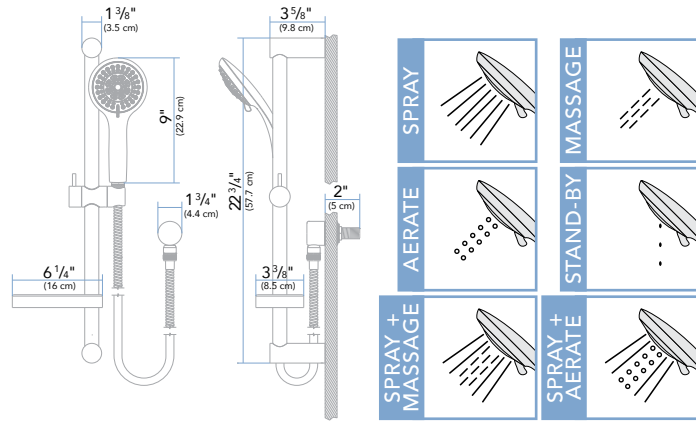

Elite Slide Bar Shower

- 6-function, heavy duty, ABS plastic sprayer with self-cleaning jets
- Water conserving "stand-by" setting (NOTE: "stand-by" is NOT a complete water shut-off, it allows a small amount of water to continue to trickle)
- Heavy duty hose
- All brass 90° bulkhead elbow with brass nipple
- Extra deep adjustable plastic soap dish
- Easy-locking adjustable height and rotating sprayer holder grips firmly where positioned anywhere along the bar to allow for infinite positioning
- 1" diameter metal bar and all brass posts with stainless steel mounting hardware
- Single hole mount, 1" Ø
- Connections: 1/2" NPS-M

OEM #	Aftermarket #	Finish	Sprayer Type	Hose Length	Hose Type
--	135-0000-CP	Chrome	6-Function	6' (1.8m)	Stainless Steel

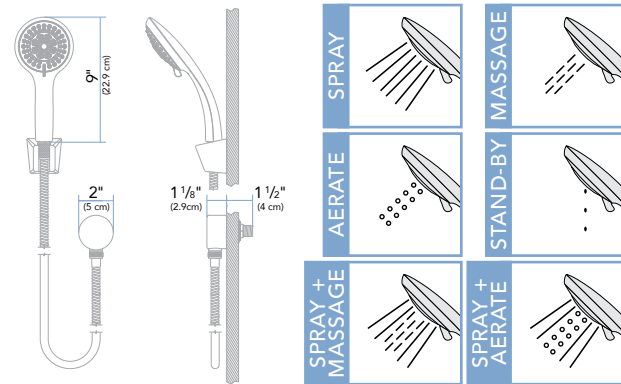

Hand-Held Shower

- 6-function, heavy duty, ABS plastic sprayer with self-cleaning jets
- Water conserving "stand-by" setting (NOTE: "stand-by" is NOT a complete water shut-off, it allows a small amount of water to continue to trickle)
- Heavy duty hose
- ABS plastic 90° bulkhead elbow with brass nipple
- 2-position ABS plastic bulkhead sprayer holder with stainless steel mounting hardware
- Single hole mount, 1" Ø
- Connections: 1/2" NPS-M

OEM #	Aftermarket #	Finish	Sprayer Type	Hose Length	Hose Type
134-0003-CP	135-0003-CP	Chrome	6-Function	6' (1.8m)	Stainless Steel



REGULATOR 28
FEATURING STASIS™ HEAD FAUCET# 132-0100-CP
& STAINLESS STEEL SINK# S24-1408-UM

OEM # – Not Labeled Or Packaged For Resale Aftermarket # – Labeled And Packaged For Resale NOTE: Dimension Drawings ±1/16" (for reference only – may not be to scale)

MARINE GRADE

SHOWER ACCESSORIES

Bulkhead Sprayer Holder 2-Position

- Works with most standard 1/2" conical hoses
- Two positions allows sprayers to sit up-right or angled
- Heavy duty, ABS plastic
- Stainless steel mounting screws



OEM #	Aftermarket #	Finish
--	131-0042-CP	Chrome

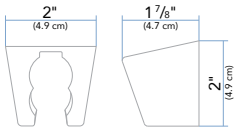

Bulkhead Sprayer Holder w/Locking Teeth

- Specific for use with Ambassador Marine sprayers with 15/1 Metric-F connection
- Unique "Locking Teeth" prevent sprayer with corresponding Locking Teeth from rotating while in faucet body or bulkhead holder
- Heavy duty, ABS plastic
- Stainless steel mounting screws



Aidack™ Pull-Out Deck Taps & Trinidad™ Head/Shower Combo Faucets

OEM #	Aftermarket #	Finish
--	131-0212-CP	Chrome

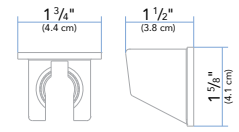

FOR USE WITH:

"Locking Teeth" prevent sprayer from rotating while in faucet body or bulkhead holder

Stand-By Switch

- Works with most standard 1/2" hoses
- All brass
- NOTE: "stand-by" is NOT a complete water shut-off, it allows a small amount of water to continue to trickle
- Connections: 1/2" NPS-M & 1/2" NPS-F



OEM #	Aftermarket #	Finish
--	131-0013-CP	Chrome

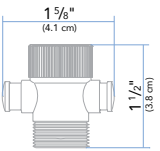

90° Bulkhead Elbow

- Works with most standard 1/2" hoses
- All brass
- Allows hose to hang flat against the bulkhead
- Designed for thin (fiberglass) walls/surfaces
- Easy installation – mounts directly to bulkhead, brass pipe nipple and lock nut included
- Single hole mount, 1" Ø
- Connections: 1/2" NPS-M & 1/2" NPS-M



OEM #	Aftermarket #	Finish
130-0015-CP	131-0015-CP	Chrome
130-0015-CG∞	--	Chrome & 18k Gold

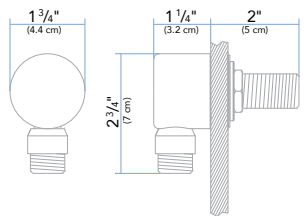

Tub Spout

- All brass
- Pull-up diverter control to switch between tub and shower
- Single hole mount, 1" Ø
- Connections: 1/2" NPS-F



OEM #	Aftermarket #	Finish
134-0006-CP∞	--	Chrome
134-0006-GP∞	--	18k Gold

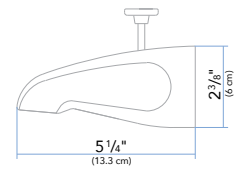

OEM # – Not Labeled Or Packaged For Resale Aftermarket # – Labeled And Packaged For Resale NOTE: Dimension Drawings ±1/16" (for reference only – may not be to scale)

HEAD ACCESSORIES

MARINE GRADE



Head Accessories

ELINA™ SERIES

- All metal with brass body and base
- Mounting hardware included

OEM #	Aftermarket #	Finish	Item
130-1910-CP	--	Chrome	Robe Hook
130-1907-CP	--	Chrome	Towel Ring
130-1908-CP	--	Chrome	Cup Holder
130-1909-CP	--	Chrome	Soap Dish
130-1901-CP	--	Chrome	Single Post T.P. Holder
130-1925-CP	--	Chrome	18" (45.7 cm) Towel Bar Set
130-1938-CP	--	Chrome	24" (60.9 cm) Towel Bar Set

COORDINATES WITH:

AIDACK™ SERIES
ALLURE™ SERIES
AVIANI™ SERIES



Head Accessories

ERISSA™ SERIES

- All metal with brass body and base
- Mounting hardware included

OEM #	Aftermarket #	Finish	Item
130-2210-CP	--	Chrome	Robe Hook
130-2207-CP	--	Chrome	Towel Ring
130-2208-CP	--	Chrome	Cup Holder
130-2209-CP	--	Chrome	Soap Dish
130-2201-CP	--	Chrome	Single Post T.P. Holder
130-2225-CP	--	Chrome	18" (45.7 cm) Towel Bar Set
130-2239-CP	--	Chrome	Soap Basket
130-2210-NP	--	Brushed Nickel	Robe Hook
130-2207-NP	--	Brushed Nickel	Towel Ring
130-2208-NP	--	Brushed Nickel	Cup Holder
130-2209-NP	--	Brushed Nickel	Soap Dish
130-2201-NP	--	Brushed Nickel	Single Post T.P. Holder
130-2225-NP	--	Brushed Nickel	18" (45.7 cm) Towel Bar Set
130-2239-NP	--	Brushed Nickel	Soap Basket

COORDINATES WITH:

ARTAINE™ SERIES

OEM # -- Not Labeled Or Packaged For Resale Aftermarket # -- Labeled And Packaged For Resale NOTE: Dimension Drawings ±1/16" (for reference only - may not be to scale)

For more information, please visit ambassadormarine.com

HEAD ACCESSORIES

MARINE GRADE



Head Accessories

MIAH™ SERIES

- All metal
- Mounting hardware included

OEM #	Aftermarket #	Finish	Item
130-1810-CP	--	Chrome	Robe Hook
130-1807-CP	--	Chrome	Towel Ring
130-1808-CP	--	Chrome	Cup Holder
130-1809-CP	--	Chrome	Soap Dish
130-1839-CP	--	Chrome	Soap Basket
130-1801-CP	--	Chrome	Single Post T.P. Holder
130-1826-CP	--	Chrome	Double Post T.P. Holder Set
130-1825-CP	--	Chrome	18" (45.7 cm) Towel Bar Set
130-1838-CP	--	Chrome	24" (60.9 cm) Towel Bar Set
130-1810-NP	--	Brushed Nickel	Robe Hook
130-1807-NP	--	Brushed Nickel	Towel Ring
130-1808-NP	--	Brushed Nickel	Cup Holder
130-1809-NP	--	Brushed Nickel	Soap Dish
130-1839-NP	--	Brushed Nickel	Soap Basket
130-1801-NP	--	Brushed Nickel	Single Post T.P. Holder
130-1826-NP	--	Brushed Nickel	Double Post T.P. Holder Set
130-1825-NP	--	Brushed Nickel	18" (45.7 cm) Towel Bar Set
130-1838-NP	--	Brushed Nickel	24" (60.9 cm) Towel Bar Set

COORDINATES WITH:

IRVA™ SERIES
PACIFICA™ SERIES
STASIS™ SERIES
TRINIDAD™ SERIES

MARINE GRADE

DRINK HOLDERS

Single Drink Holder

- Solid cast 316 stainless steel
- Deck-mount
- Ideal for mugs with handles
- Uses #10 fasteners (not included)



OEM #	Aftermarket #	Finish
P56-8821-SS	P56-8820-SS	Stainless Steel

Double Drink Holder

- Solid cast 316 stainless steel
- Deck-mount
- Ideal for mugs with handles
- Uses #10 fasteners (not included)

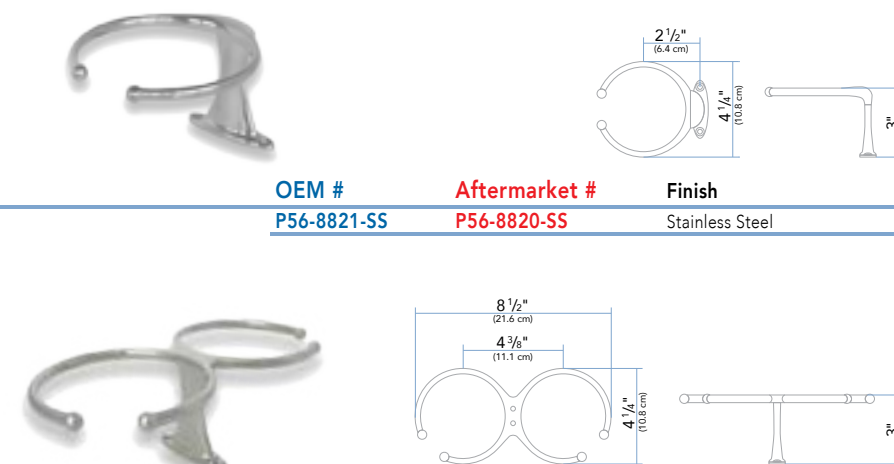

OEM #	Aftermarket #	Finish
P56-8801-SS	P56-8800-SS	Stainless Steel

OEM # -- Not Labeled Or Packaged For Resale Aftermarket # -- Labeled And Packaged For Resale NOTE: Dimension Drawings ±1/16" (for reference only - may not be to scale)

For more information, please visit ambassadormarine.com



Small Marine Sprayer

	OEM #	Aftermarket #	Sprayer Finish	Elbow	Connection	Integrated Hook
• Complete water shut-off when trigger is not engaged	138-0000-AW	138-0000-AW-R	Arctic White	No	1/2" NPS-M	Yes
• Depressing trigger allows for intermittent water flow – lifting trigger locks it on for continuous water flow	138-0001-AW	138-0001-AW-R	Arctic White	No	1/2" NPS-M	No
• Heavy duty, UV protected, ABS plastic	138-0002-AW	138-0002-AW-R	Arctic White & Chrome	Yes	1/2" NPS-M	Yes
• With or without chrome plated brass elbow	138-0003-AW	138-0003-AW-R	Arctic White & Chrome	Yes	1/2" NPS-M	No
• With or without removable hook	138-0005-AW	138-0005-AW-R	Arctic White & Chrome	Yes	15/1 Metric-F w/ Locking Teeth	No
• 316 stainless steel internal plunger rod	138-0000-WH	139-0000-WH	Warm White	No	1/2" NPS-M	Yes
• Connection: 1/2" NPS-M or 15/1 Metric-F	138-0001-WH	138-0001-WH-R	Warm White	No	1/2" NPS-M	No
	138-0002-WH	138-0002-WH-R	Warm White & Chrome	Yes	1/2" NPS-M	Yes
	138-0003-WH	138-0003-WH-R	Warm White & Chrome	Yes	1/2" NPS-M	No
	138-0005-WH	138-0005-WH-R	Warm White & Chrome	Yes	15/1 Metric-F w/ Locking Teeth	No
	138-0000-CP	138-0000-CP-R	Chrome	No	1/2" NPS-M	Yes
	138-0001-CP	138-0001-CP-R	Chrome	No	1/2" NPS-M	No
	138-0002-CP	138-0002-CP-R	Chrome	Yes	1/2" NPS-M	Yes
	138-0003-CP	138-0003-CP-R	Chrome	Yes	1/2" NPS-M	No
	138-0005-CP	138-0005-CP-R	Chrome	Yes	15/1 Metric-F w/ Locking Teeth	No
	138-0000-KP	138-0000-KP-R	Black	No	1/2" NPS-M	Yes
	138-0001-KP	138-0001-KP-R	Black	No	1/2" NPS-M	No
	138-0002-KP	138-0002-KP-R	Black & Chrome	Yes	1/2" NPS-M	Yes
	138-0003-KP	138-0003-KP-R	Black & Chrome	Yes	1/2" NPS-M	No
	138-0005-KP	138-0005-KP-R	Black & Chrome	Yes	15/1 Metric-F w/ Locking Teeth	No

"Locking Teeth" prevent sprayer from rotating while in faucet body or bulkhead holder



Large Marine Sprayer

	OEM #	Aftermarket #	Sprayer Finish	Elbow	Connection	Integrated Hook
• Complete water shut-off when trigger is not engaged	138-0100-WH [∞]	--	Warm White	No	1/2" NPS-M	Yes
• Depressing trigger allows for intermittent water flow – lifting trigger locks it on for continuous water flow	138-0102-WH [∞]	--	Warm White & Chrome	Yes	1/2" NPS-M	Yes
• Heavy duty, UV protected, ABS plastic	138-0105-WH [∞]	--	Warm White & Chrome	Yes	15/1 Metric-F w/ Locking Teeth	No
• With or without chrome plated brass elbow	138-0100-CP [∞]	--	Chrome	No	1/2" NPS-M	Yes
• With or without removable hook	138-0102-CP [∞]	--	Chrome	Yes	1/2" NPS-M	Yes
• 316 stainless steel internal plunger rod	138-0105-CP [∞]	--	Chrome	Yes	15/1 Metric-F w/ Locking Teeth	No
• Connection: 1/2" NPS-M or 15/1 Metric-F	138-0100-KP [∞]	--	Black	No	1/2" NPS-M	Yes
	138-0102-KP [∞]	--	Black & Chrome	Yes	1/2" NPS-M	Yes
	138-0105-KP [∞]	--	Black & Chrome	Yes	15/1 Metric-F w/ Locking Teeth	No

"Locking Teeth" prevent sprayer from rotating while in faucet body or bulkhead holder

OEM # – Not Labeled Or Packaged For Resale Aftermarket # – Labeled And Packaged For Resale NOTE: Dimension Drawings ±1/16" (for reference only – may not be to scale) ∞ Available While Supplies Last



Hammer-Head Marine Sprayer

	OEM #	Aftermarket #	Sprayer Finish	Elbow	Connection	Integrated Hook
• Complete water shut-off when trigger is not engaged	138-0300-CA	138-0300-CA-R	Arctic White & Chrome	No	1/2" NPS-M	Yes
• Depressing trigger allows for intermittent water flow – lifting trigger locks it on for continuous water flow	138-0301-CA	138-0301-CA-R	Arctic White & Chrome	No	1/2" NPS-M	No
• Heavy duty, UV protected, ABS plastic and chrome plated brass	138-0303-CA	138-0303-CA-R	Arctic White & Chrome	Yes	1/2" NPS-M	No
• All brass head and trigger	138-0300-CW	138-0300-CW-R	Warm White & Chrome	No	1/2" NPS-M	Yes
• With or without elbow	138-0301-CW	138-0301-CW-R	Warm White & Chrome	No	1/2" NPS-M	No
• With or without removable hook	138-0303-CW	138-0303-CW-R	Warm White & Chrome	Yes	1/2" NPS-M	No
• Connection: 1/2" NPS-M	138-0309-CW [∞]	--	Warm White & Chrome	No	1/2" NPS-M For "Elite Base" Only	No
	138-0311-CW [∞]	--	Warm White & Chrome	Yes	1/2" NPS-M For "Elite Base" Only	No
	138-0300-CK	138-0300-CK-R	Black & Chrome	No	1/2" NPS-M	Yes
	138-0301-CK	138-0301-CK-R	Black & Chrome	No	1/2" NPS-M	No
	138-0303-CK	138-0303-CK-R	Black & Chrome	Yes	1/2" NPS-M	No
	138-0309-CK [∞]	--	Black & Chrome	No	1/2" NPS-M For "Elite Base" Only	No
	138-0311-CK [∞]	--	Black & Chrome	Yes	1/2" NPS-M For "Elite Base" Only	No



Classic Marine Sprayer

	OEM #	Aftermarket #	Sprayer Finish	Elbow	Connection	Integrated Hook
• 2-function spray/aerated stream with water conserving "stand-by" button (NOTE: "stand-by" is NOT a complete water shut-off, it allows a small amount of water to continue to trickle)	138-0205-CA	138-0205-CA-R	Arctic White & Chrome	Yes	15/1 Metric-F w/ Locking Teeth	--
• Heavy duty, UV protected, ABS plastic and chrome plated brass	138-0203-CW	138-0203-CW-R	Warm White & Chrome	Yes	1/2" NPS-M	--
• Connection: 1/2" NPS-M or 15/1 Metric-F	138-0205-CW	138-0205-CW-R	Warm White & Chrome	Yes	15/1 Metric-F w/ Locking Teeth	--
	138-0207-CW [∞]	--	Warm White & Chrome	Yes	15/1 Metric-F NO Locking Teeth	--
	138-0203-CK	138-0203-CK-R	Black & Chrome	Yes	1/2" NPS-M	--
	138-0205-CK	138-0205-CK-R	Black & Chrome	Yes	15/1 Metric-F w/ Locking Teeth	--
	138-0207-CK [∞]	--	Black & Chrome	Yes	15/1 Metric-F NO Locking Teeth	--

"Locking Teeth" prevent sprayer from rotating while in faucet body or bulkhead holder



Pull-Out Kitchen Sprayer

	OEM #	Aftermarket #	Sprayer Finish	Elbow	Connection	Integrated Hook
• 2-function spray/aerated stream	138-0401-CP	--	Chrome	No	1/2" NPS-M	No
• Heavy duty, UV protected, ABS plastic	138-0405-CP	--	Chrome	Yes	15/1 Metric-F w/ Locking Teeth	No
• With or without chrome plated brass elbow	138-0401-NP	--	Brushed Nickel	No	1/2" NPS-M	No
• Connection: 1/2" NPS-M or 15/1 Metric-F						

"Locking Teeth" prevent sprayer from rotating while in faucet body or bulkhead holder

OEM # – Not Labeled Or Packaged For Resale Aftermarket # – Labeled And Packaged For Resale NOTE: Dimension Drawings ±1/16" (for reference only – may not be to scale) ∞ Available While Supplies Last

15/1 Metric-M



1/2" NPS-F



Hose

15/1 Metric-M + 1/2" NPS-F

- Brass fittings
- Female fitting(s) include rubber washer(s)

Rubber Hoses

- Heavy duty, UV protected, nylon hose
- UV protection prevents discoloring and reduces cracking

Stainless Steel Hoses

- Heavy duty, continuous polished stainless steel ribbon wrapped around soft inner nylon hose
- Extremely flexible with little-to-no "memory"

FOR USE WITH:
Aidack™ Pull-Out Deck Taps & Trinidad™ Head/Shower Combo Faucets

OEM #	Aftermarket #	Finish	Hose Length	Hose Type
130-0017-WH	131-0017-WH	White	6' (1.8m)	Rubber
130-0028-WH	130-0028-WH-R	White	10' (3m)	Rubber
130-0017-KP	130-0017-KP-R	Black	6' (1.8m)	Rubber
130-0028-KP	130-0028-KP-R	Black	10' (3m)	Rubber
130-0017-SS	130-0017-SS-R	Stainless Steel	6' (1.8m)	Stainless Steel
130-0028-SS	130-0028-SS-R	Stainless Steel	10' (3m)	Stainless Steel

1/2" NPS-F
Conical



1/2" NPS-F



Hose

1/2" NPS-F Conical + 1/2" NPS-F

- Brass fittings
- Female fitting(s) include rubber washer(s)

Rubber Hoses

- Heavy duty, UV protected, nylon hose
- UV protection prevents discoloring and reduces cracking

Stainless Steel Hoses

- Heavy duty, continuous polished stainless steel ribbon wrapped around soft inner nylon hose
- Extremely flexible with little-to-no "memory"

FOR USE WITH:
Recessed / Transom / Slide Bar / Hand-Held Showers & Deck Sprayers with Elite Deck Holders

OEM #	Aftermarket #	Finish	Hose Length	Hose Type
130-0033-WH	130-0033-WH-R	White	6' (1.8m)	Rubber
130-0018-WH	130-0018-WH-R	White	10' (3m)	Rubber
130-0033-KP	130-0033-KP-R	Black	6' (1.8m)	Rubber
130-0018-KP	130-0018-KP-R	Black	10' (3m)	Rubber
130-0033-SS	130-0033-SS-R	Stainless Steel	6' (1.8m)	Stainless Steel
130-0018-SS	130-0018-SS-R	Stainless Steel	10' (3m)	Stainless Steel
130-0031-CK∞	--	Chrome & Black	6' (1.8m)	Rubber

1/2" NPS-F
Conical



1/2" NPS-F
Adapter



Hose

1/2" NPS-F Conical + 1/2" NPS-F Adapter

- Brass fittings
- Female fitting(s) include rubber washer(s)

Rubber Hoses

- Heavy duty, UV protected, nylon hose
- UV protection prevents discoloring and reduces cracking

Stainless Steel Hoses

- Heavy duty, continuous polished stainless steel ribbon wrapped around soft inner nylon hose
- Extremely flexible with little-to-no "memory"

FOR USE WITH:
Deck Sprayers with Standard Deck Holders

OEM #	Aftermarket #	Finish	Hose Length	Hose Type
130-0032-WH	130-0032-WH-R	White	6' (1.8m)	Rubber
130-0029-WH	130-0029-WH-R	White	10' (3m)	Rubber
130-0032-KP	130-0032-KP-R	Black	6' (1.8m)	Rubber
130-0029-KP	130-0029-KP-R	Black	10' (3m)	Rubber
130-0032-SS	130-0032-SS-R	Stainless Steel	6' (1.8m)	Stainless Steel
130-0029-SS	130-0029-SS-R	Stainless Steel	10' (3m)	Stainless Steel

OEM # - Not Labeled Or Packaged For Resale Aftermarket # - Labeled And Packaged For Resale NOTE: Dimension Drawings ±1/16" (for reference only - may not be to scale)

Spout
Head



Quick-Connect
(Type B)



Hose

Spout Head + Quick-Connect (B)

- Proprietary quick-connect fitting
- Heavy duty, continuous polished stainless steel ribbon wrapped around soft inner nylon hose
- Extremely flexible with little-to-no "memory"
- Brass fittings

FOR USE WITH:
Pull-Out Faucets with Quick-Connect (B) Pull-Out Hose Connections

OEM #	Aftermarket #	Finish	Hose Length	Hose Type
130-0043-SS	130-0043-SS-R	Stainless Steel	4' (1.2m)	Stainless Steel
130-0044-SS	130-0044-SS-R	Stainless Steel	6' (1.8m)	Stainless Steel
130-0045-SS	130-0045-SS-R	Stainless Steel	10' (3m)	Stainless Steel

Spout
Head



Quick-Connect
(Type A)
Shown without adapter, sold separately



Hose

Spout Head + Quick-Connect Adapter (A)

- Proprietary quick-connect fitting
- Requires screw-on quick-connect adapter, sold separately
- Heavy duty, continuous polished stainless steel ribbon wrapped around soft inner nylon hose
- Extremely flexible with little-to-no "memory"
- Brass fittings

FOR USE WITH:
Pull-Out Faucets with Quick-Connect (A) Pull-Out Hose Connections

OEM #	Aftermarket #	Finish	Hose Length	Hose Type
130-0037-SS∞	--	Stainless Steel	4' (1.2m)	Stainless Steel
130-0034-SS∞	--	Stainless Steel	6' (1.8m)	Stainless Steel



EDGEWATER 370CC
FEATURING TRINIDAD™ HEAD/SHOWER COMBO FAUCET# 134-0213-CP

OEM # - Not Labeled Or Packaged For Resale Aftermarket # - Labeled And Packaged For Resale NOTE: Dimension Drawings ±1/16" (for reference only - may not be to scale)
∞ Available While Supplies Last

VESSEL SINKS

MARINE GRADE

Our **Glass Vessel Sinks** work with over mount installations only and may be installed with or without a decorative base ring. All sinks are made from heavy tempered glass. Drain kit sold separately (see pages 57 through 62).

If you need a configuration that is not shown, simply ask your sales representative for options. Additional configurations (colors / textures / sizes) may be available. Minimum annual commitment and additional lead-time may be required for non-standard configurations.



Half Sphere Glass Vessel – Smooth Glass

- Height: 4 3/4"
- Outside dimensions: 12" Ø
- Heavy tempered glass
- Over-counter mount only
- Optional mounting base ring, sold separately
- Fits 1 3/4" drains, sold separately

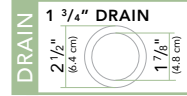

OEM #	Aftermarket #	Finish	Package Type
V21-1402-CL	V21-1402-CL-R	Clear	Each

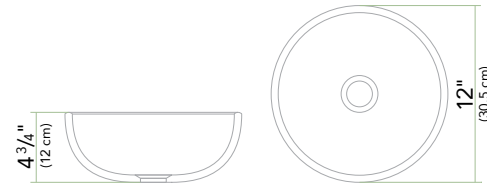

Rectangle Glass Vessel – Smooth Glass

- Height: 5 1/2"
- Outside dimensions: 16 1/2" x 16 1/2"
- Heavy tempered glass
- Over-counter mount only
- Optional mounting base ring, sold separately
- Fits 1 3/4" drains, sold separately

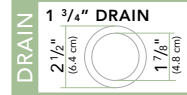

OEM #	Aftermarket #	Finish	Package Type
V41-1533-CL∞	V41-1533-CL-R∞	Clear	Each



Glass Vessel Mounting Base (Optional)

- Optional— for use with glass vessel sinks
- Lifts sink 1/2" off counter top
- Solid brass
- For use with 1 3/4" drains



OEM #	Aftermarket #	Finish
V03-0050-CP	V03-0050-CP-R	Chrome
V03-0050-NP	V03-0050-NP-R	Brushed Nickel



REGULATOR 25
FEATURING RECESSED SHOWER# 136-0043-CW



OEM # – Not Labeled Or Packaged For Resale Aftermarket # – Labeled And Packaged For Resale NOTE: Dimension Drawings ±1/16" (for reference only – may not be to scale) ∞ Available While Supplies Last

MARINE GRADE

VESSEL SINKS

Our **Porcelain Vessel Sinks** work with over mount installations only. All sinks are made from real porcelain. Drain kit sold separately (see pages 57 through 62).

If you need a configuration that is not shown, simply ask your sales representative for options. Additional configurations (colors / textures / sizes) may be available. Minimum annual commitment and additional lead-time may be required for non-standard configurations.



Half Sphere Porcelain Vessel – Smooth Surface

- Height: 5 3/4"
- Outside dimensions: 12 1/2" Ø
- Real porcelain
- Over-counter mount only
- Fits 1 3/4" drains, sold separately

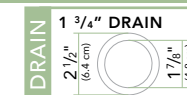

OEM #	Aftermarket #	Finish	Package Type
V28-1502-WH	V28-1502-WH-R	White	Each

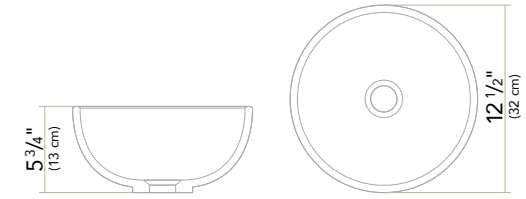

Rectangle Porcelain Vessel – Smooth Surface

- Height: 5 1/2"
- Outside dimensions: 18 3/4" x 15"
- Faucet mounts directly on sink, 1 1/2" hole
- Real porcelain
- Over-counter mount only
- Fits 1 3/4" drains, sold separately

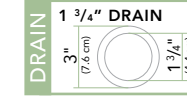

OEM #	Aftermarket #	Finish	Package Type
V48-3534-WH	V48-3534-WH-R	White	Each

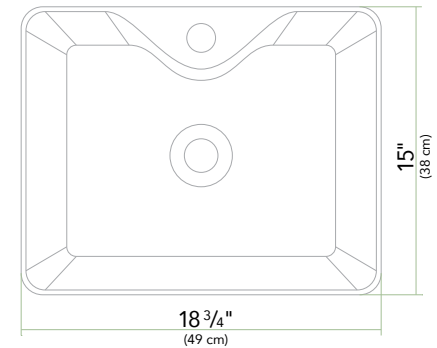

GLASS AND PORCELAIN VESSEL SINKS ARE AVAILABLE IN A WIDE VARIETY OF COLORS, SHAPES, SIZES AND TEXTURES.

Our exclusive partnerships allow us to quickly add virtually any style glass or porcelain vessel requested, ask your sales representative for options. Minimum annual commitment and additional lead-time may be required.

GLASS COLORS

- Clear
- Blue
- Smoke
- Green
- Frost
- Amber
- Purple
- Stone
- and many more!

PORCELAIN COLORS

- White
- Biscuit
- Almond
- and many more!



GLASS TEXTURES

- Smooth
- Rain
- Squares
- Triangles
- Scalloped
- and many more!

OEM # – Not Labeled Or Packaged For Resale Aftermarket # – Labeled And Packaged For Resale NOTE: Dimension Drawings ±1/16" (for reference only – may not be to scale)

STAINLESS STEEL SINKS

MARINE GRADE

Most of our **Stainless Steel Sinks** work with over or under mount installations. All sinks are made from heavy gauge 304 stainless steel and features our exclusive **SoundKOTE** – Noise Reduction Technology. Drain kit sold separately (see pages 57 through 62).

If you need a configuration that is not shown, simply ask your sales representative for options. Additional configurations (finishes / flanges / drain sizes) may be available. Minimum annual commitment and additional lead-time may be required for non-standard configurations.



Half Sphere Stainless Steel Sink

- Depth: 4 3/4"
- Outside dimensions: 9 1/2" Ø
- Bowl dimensions: 8" Ø
- 304 stainless steel, heavy gauge
- Passivated
- SoundKOTE®– Noise Reduction Technology
- Over- or under-counter mount
- Fits 2" drains, sold separately



OEM #	Aftermarket #	Finish	Package Type
S24-1408-UM	S24-1408-UM-R	Ultra-Mirror	Each
S24-1408-UM-10p	--	Ultra-Mirror	10-Pack
S24-1408-BR	S24-1408-BR-R	Brushed	Each
S24-1408-BR-10p	--	Brushed	10-Pack

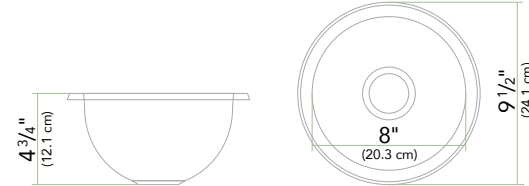

Half Sphere Stainless Steel Sink

- Depth: 4 1/4"
- Outside dimensions: 10 1/2" Ø
- Bowl dimensions: 9" Ø
- 304 stainless steel, heavy gauge
- Passivated
- SoundKOTE®– Noise Reduction Technology
- Over- or under-counter mount
- With mounting tabs, for over-counter mounting
- Fits 2" drains, sold separately



OEM #	Aftermarket #	Finish	Package Type
S26-1409-UM	S26-1409-UM-R	Ultra-Mirror	Each
S26-1409-UM-10p	--	Ultra-Mirror	10-Pack
S26-1409-BR	S26-1409-BR-R	Brushed	Each
S26-1409-BR-10p	--	Brushed	10-Pack

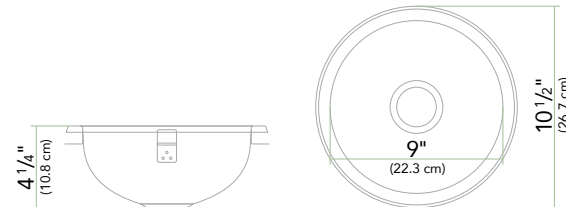

Drains

sold separately (see pages 57-62)



Under-Mount Sink Brackets

optional for solid surfaces or stone counters
sold separately (see page 62)



SOLACE 41CS
FEATURING AIDACK™ ELITE FOLDING FAUCET# 132-1427-CP
& STAINLESS STEEL SINK# S44-1610-UM

OEM # – Not Labeled Or Packaged For Resale Aftermarket # – Labeled And Packaged For Resale NOTE: Dimension Drawings ±1/8" (for reference only – may not be to scale)

STAINLESS STEEL SINKS

MARINE GRADE



Half Sphere Stainless Steel Sink

- Depth: 4 7/8"
- Outside dimensions: 11 1/2" Ø
- Bowl dimensions: 10 1/4" Ø
- 304 stainless steel, heavy gauge
- Passivated
- SoundKOTE®– Noise Reduction Technology
- Over- or under-counter mount
- Fits 1 1/2" drains, sold separately



OEM #	Aftermarket #	Finish	Package Type
S24-6400-UM	S24-6400-UM-R	Ultra-Mirror	Each
S24-6400-UM-10p	--	Ultra-Mirror	10-Pack

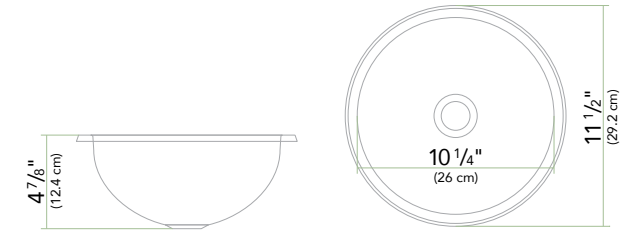

Half Sphere Stainless Steel Sink

- Depth: 4 3/4"
- Outside dimensions: 11 1/2" Ø
- Bowl dimensions: 10 1/4" Ø
- 304 stainless steel, heavy gauge
- Passivated
- SoundKOTE®– Noise Reduction Technology
- Over- or under-counter mount
- Fits 2" drains, sold separately



OEM #	Aftermarket #	Finish	Package Type
S24-1400-UM	S24-1400-UM-R	Ultra-Mirror	Each
S24-1400-UM-10p	--	Ultra-Mirror	10-Pack



Half Sphere Stainless Steel Sink

- Depth: 5 7/8"
- Outside dimensions: 13 1/4" Ø
- Bowl dimensions: 11 3/4" Ø
- 304 stainless steel, heavy gauge
- Passivated
- SoundKOTE®– Noise Reduction Technology
- Over- or under-counter mount
- Fits 2" drains, sold separately

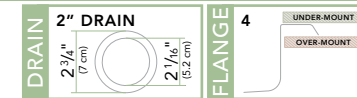

OEM #	Aftermarket #	Finish	Package Type
S24-1501-UM	S24-1501-UM-R	Ultra-Mirror	Each
S24-1501-UM-10p	--	Ultra-Mirror	10-Pack



Drains

sold separately (see pages 57-62)



Under-Mount Sink Brackets

optional for solid surfaces or stone counters
sold separately (see page 62)



OEM # – Not Labeled Or Packaged For Resale Aftermarket # – Labeled And Packaged For Resale NOTE: Dimension Drawings ±1/8" (for reference only – may not be to scale)

STAINLESS STEEL SINKS

MARINE GRADE

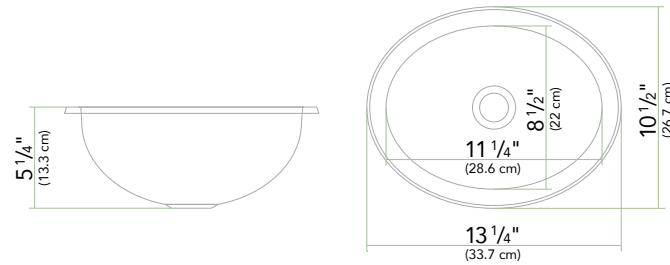

Oval Stainless Steel Sink

- Depth: 5 1/4"
- Outside dimensions: 13 1/4" x 10 1/2"
- Bowl dimensions: 11 1/4" x 8 1/2"
- 304 stainless steel, heavy gauge
- Passivated
- SoundKOTE®- Noise Reduction Technology
- Over- or under-counter mount
- Fits 1 1/2" drains, sold separately



OEM #	Aftermarket #	Finish	Package Type
S64-6530-UM	S64-6530-UM-R	Ultra-Mirror	Each
S64-6530-UM-10p	--	Ultra-Mirror	10-Pack
S64-6530-BR	S64-6530-BR-R	Brushed	Each
S64-6530-BR-10p	--	Brushed	10-Pack

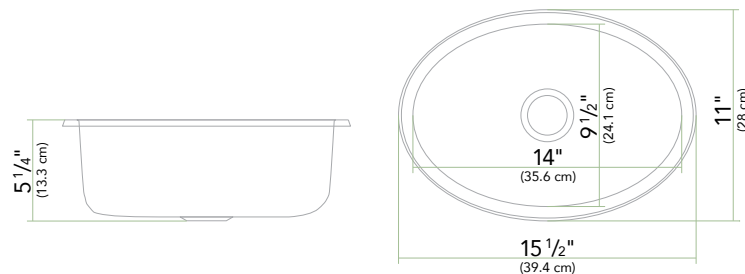

Oval Stainless Steel Sink

- Depth: 5 1/4"
- Outside dimensions: 13 1/4" x 10 1/2"
- Bowl dimensions: 11 1/4" x 8 1/2"
- 304 stainless steel, heavy gauge
- Passivated
- SoundKOTE®- Noise Reduction Technology
- Over- or under-counter mount
- Fits 2" drains, sold separately



OEM #	Aftermarket #	Finish	Package Type
S64-1515-UM	S64-1515-UM-R	Ultra-Mirror	Each
S64-1515-UM-10p	--	Ultra-Mirror	10-Pack

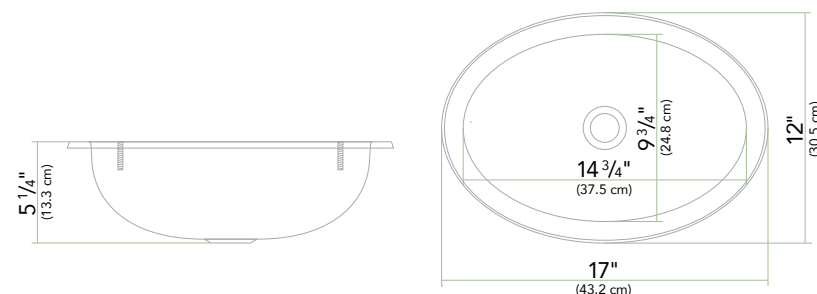

Oval Stainless Steel Sink

- Depth: 5 1/4"
- Outside dimensions: 17" x 12"
- Bowl dimensions: 14 3/4" x 9 3/4"
- 304 stainless steel, heavy gauge
- Passivated
- SoundKOTE®- Noise Reduction Technology
- Over- or under-counter mount
- With mounting studs, for over-counter mounting
- Fits 1 1/2" drains, sold separately



OEM #	Aftermarket #	Finish	Package Type
S67-6515-UM	S67-6515-UM-R	Ultra-Mirror	Each
S67-6515-UM-10p	--	Ultra-Mirror	10-Pack
S67-6515-BR	S67-6515-BR-R	Brushed	Each
S67-6515-BR-10p	--	Brushed	10-Pack

Drains

sold separately (see pages 57-62)



Under-Mount Sink Brackets

optional for solid surfaces or stone counters
sold separately (see page 62)

OEM # - Not Labeled Or Packaged For Resale Aftermarket # - Labeled And Packaged For Resale NOTE: Dimension Drawings ±1/16" (for reference only - may not be to scale)

STAINLESS STEEL SINKS

MARINE GRADE



Cylinder Stainless Steel Sink

- Depth: 5 1/4"
- Outside dimensions: 11 1/2" Ø
- Bowl dimensions: 10 1/8" Ø
- 304 stainless steel, heavy gauge
- Passivated
- SoundKOTE®- Noise Reduction Technology
- Over- or under-counter mount
- Fits 2" drains, sold separately



OEM #	Aftermarket #	Finish	Package Type
S14-2500-UM	S14-2500-UM-R	Ultra-Mirror	Each
S14-2500-UM-10p	--	Ultra-Mirror	10-Pack
S14-2500-BR	S14-2500-BR-R	Brushed	Each
S14-2500-BR-10p	--	Brushed	10-Pack

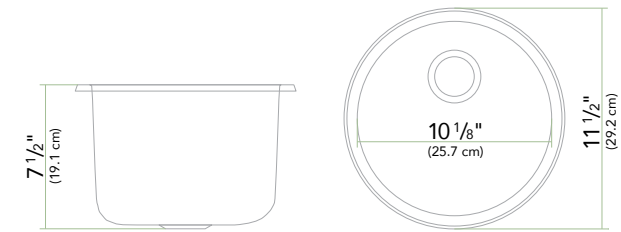

Cylinder Stainless Steel Sink

- Depth: 7 1/2"
- Outside dimensions: 11 1/2" Ø
- Bowl dimensions: 10 1/8" Ø
- 304 stainless steel, heavy gauge
- Passivated
- SoundKOTE®- Noise Reduction Technology
- Over- or under-counter mount
- Fits 2" drains, sold separately



OEM #	Aftermarket #	Finish	Package Type
S14-2700-UM	S14-2700-UM-R	Ultra-Mirror	Each
S14-2700-UM-10p	--	Ultra-Mirror	10-Pack

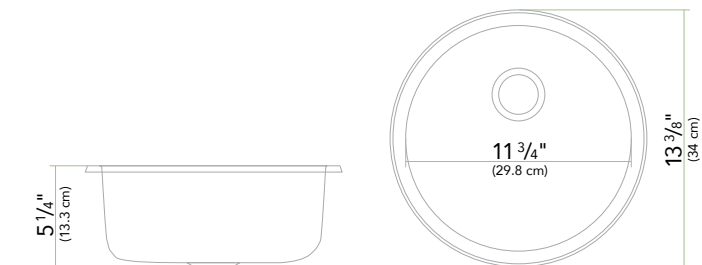

Cylinder Stainless Steel Sink

- Depth: 5 1/4"
- Outside dimensions: 13 3/8" Ø
- Bowl dimensions: 11 3/4" Ø
- 304 stainless steel, heavy gauge
- Passivated
- SoundKOTE®- Noise Reduction Technology
- Over- or under-counter mount
- Fits 2" drains, sold separately



OEM #	Aftermarket #	Finish	Package Type
S14-2501-UM	S14-2501-UM-R	Ultra-Mirror	Each
S14-2501-UM-10p	--	Ultra-Mirror	10-Pack
S14-2501-BR	S14-2501-BR-R	Brushed	Each
S14-2501-BR-10p	--	Brushed	10-Pack

Drains

sold separately (see pages 57-62)



Under-Mount Sink Brackets

optional for solid surfaces or stone counters
sold separately (see page 62)

OEM # - Not Labeled Or Packaged For Resale Aftermarket # - Labeled And Packaged For Resale NOTE: Dimension Drawings ±1/16" (for reference only - may not be to scale)

STAINLESS STEEL SINKS

MARINE GRADE

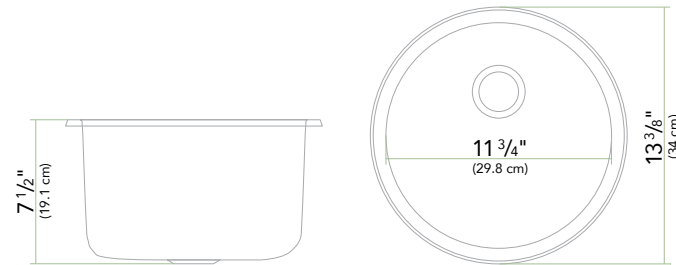

Cylinder Stainless Steel Sink

- Depth: 7 1/4"
- Outside dimensions: 13 3/8" Ø
- Bowl dimensions: 11 3/4" Ø
- 304 stainless steel, heavy gauge
- Passivated
- SoundKOTE®- Noise Reduction Technology
- Over- or under-counter mount
- Fits 2" drains, sold separately

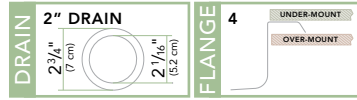

OEM #	Aftermarket #	Finish	Package Type
S14-2701-UM	S14-2701-UM-R	Ultra-Mirror	Each
S14-2701-UM-10p	--	Ultra-Mirror	10-Pack



Cylinder Stainless Steel Sink

- Depth: 6"
- Outside dimensions: 15" Ø
- Bowl dimensions: 12 3/8" Ø
- 304 stainless steel, heavy gauge
- Passivated
- SoundKOTE®- Noise Reduction Technology
- Over- or under-counter mount
- Fits 2" drains, sold separately



OEM #	Aftermarket #	Finish	Package Type
S14-2602-UM	S14-2602-UM-R	Ultra-Mirror	Each
S14-2602-UM-10p	--	Ultra-Mirror	10-Pack

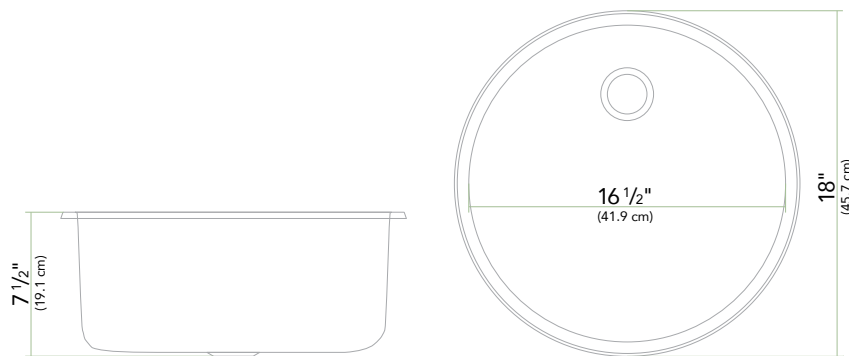

Cylinder Stainless Steel Sink

- Depth: 7 1/2"
- Outside dimensions: 18" Ø
- Bowl dimensions: 16 1/2" Ø
- 304 stainless steel, heavy gauge
- Passivated
- SoundKOTE®- Noise Reduction Technology
- Over- or under-counter mount
- Fits 2" drains, sold separately



OEM #	Aftermarket #	Finish	Package Type
S14-2706-BR	S14-2706-BR-R	Brushed	Each
S14-2706-BR-5p	--	Brushed	5-Pack

Drains

sold separately (see pages 57-62)



Under-Mount Sink Brackets

optional for solid surfaces or stone counters
sold separately (see page 62)



OEM # - Not Labeled Or Packaged For Resale Aftermarket # - Labeled And Packaged For Resale NOTE: Dimension Drawings ±1/16" (for reference only - may not be to scale)

MARINE GRADE

STAINLESS STEEL SINKS

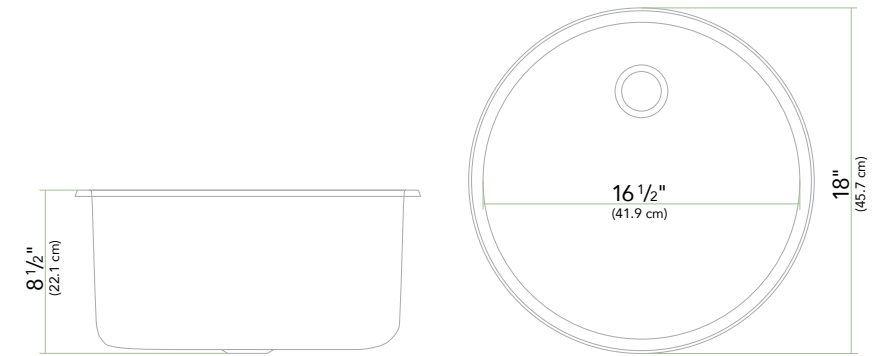

Cylinder Stainless Steel Sink

- Depth: 8 1/2"
- Outside dimensions: 18" Ø
- Bowl dimensions: 16 1/2" Ø
- 304 stainless steel, heavy gauge
- Passivated
- SoundKOTE®- Noise Reduction Technology
- Over- or under-counter mount
- Fits 2" drains, sold separately



OEM #	Aftermarket #	Finish	Package Type
S14-2806-UM	S14-2806-UM-R	Ultra-Mirror	Each
S14-2806-UM-5p	--	Ultra-Mirror	5-Pack

Drains

sold separately (see pages 57-62)



Under-Mount Sink Brackets

optional for solid surfaces or stone counters
sold separately (see page 62)



INTREPID 477 EVOLUTION
FEATURING TRINIDAD™ ELITE FOLDING FAUCET# 133-0210-CP
& STAINLESS STEEL SINK# S26-1409-BR



SEA RAY SLX 310
FEATURING AIDACK™ ELITE FOLDING TAP# 132-1739-CP
& STAINLESS STEEL SINK# S64-6530-UM

OEM # - Not Labeled Or Packaged For Resale Aftermarket # - Labeled And Packaged For Resale NOTE: Dimension Drawings ±1/16" (for reference only - may not be to scale)

STAINLESS STEEL SINKS

MARINE GRADE

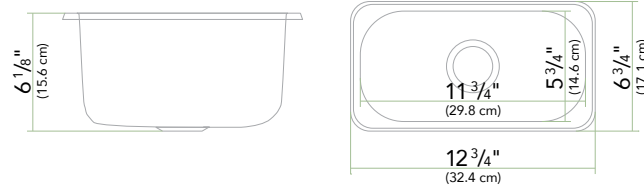

Rectangle Stainless Steel Sink

- Depth: 6 1/8"
- Outside dimensions: 12 3/4" x 6 3/4"
- Bowl dimensions: 11 3/4" x 5 3/4"
- 304 stainless steel, heavy gauge
- Passivated
- SoundKOTE®- Noise Reduction Technology
- Over- or under-counter mount
- Fits 2" drains, sold separately



OEM #	Aftermarket #	Finish	Package Type
S44-1610-UM	S44-1610-UM-R	Ultra-Mirror	Each
S44-1610-UM-10p	--	Ultra-Mirror	10-Pack
S44-1610-BR	S44-1610-BR-R	Brushed	Each
S44-1610-BR-10p	--	Brushed	10-Pack

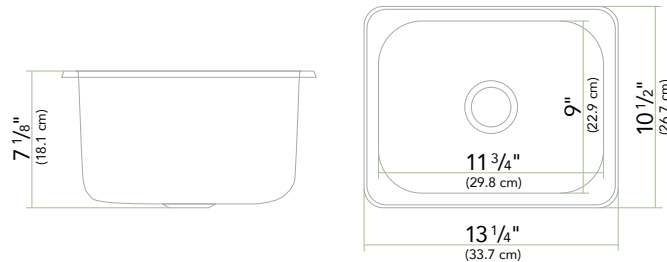

Rectangle Stainless Steel Sink

- Depth: 7 1/8"
- Outside dimensions: 13 1/4" x 10 1/2"
- Bowl dimensions: 11 3/4" x 9"
- 304 stainless steel, heavy gauge
- Passivated
- SoundKOTE®- Noise Reduction Technology
- Over- or under-counter mount
- Fits 2" drains, sold separately

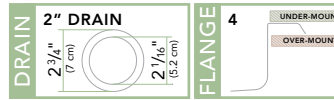

OEM #	Aftermarket #	Finish	Package Type
S44-1711-BR	S44-1711-BR-R	Brushed	Each
S44-1711-BR-5p	--	Brushed	5-Pack

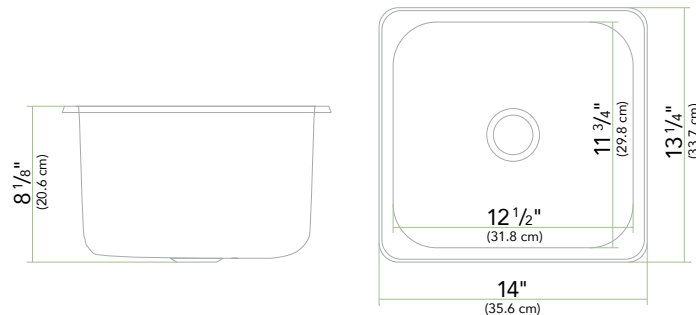

Rectangle Stainless Steel Sink

- Depth: 8 1/8"
- Outside dimensions: 14" x 13 1/4"
- Bowl dimensions: 12 1/2" x 11 3/4"
- 304 stainless steel, heavy gauge
- Passivated
- SoundKOTE®- Noise Reduction Technology
- Over- or under-counter mount
- Fits 2" drains, sold separately



OEM #	Aftermarket #	Finish	Package Type
S44-1831-UM	S44-1831-UM-R	Ultra-Mirror	Each
S44-1831-UM-5p	--	Ultra-Mirror	5-Pack
S44-1831-BR	S44-1831-BR-R	Brushed	Each
S44-1831-BR-5p	--	Brushed	5-Pack

Drains

sold separately (see pages 57-62)



Under-Mount Sink Brackets

optional for solid surfaces or stone counters
sold separately (see page 62)



OEM # - Not Labeled Or Packaged For Resale Aftermarket # - Labeled And Packaged For Resale NOTE: Dimension Drawings ±1/16" (for reference only - may not be to scale)

STAINLESS STEEL SINKS

MARINE GRADE

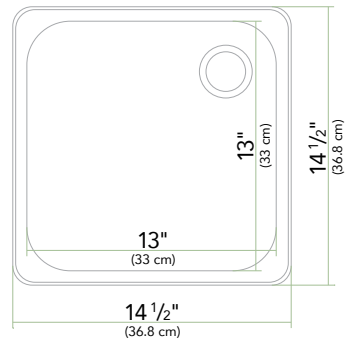

Rectangle Stainless Steel Sink

- Depth: 6 1/8"
- Outside dimensions: 14 1/2" x 14 1/2"
- Bowl dimensions: 13" x 13"
- 304 stainless steel, heavy gauge
- Passivated
- SoundKOTE®- Noise Reduction Technology
- Over- or under-counter mount
- Fits 2" drains, sold separately

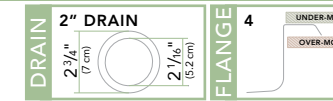

OEM #	Aftermarket #	Finish	Package Type
S44-4614-UM	S44-4614-UM-R	Ultra-Mirror	Each
S44-4614-UM-5p	--	Ultra-Mirror	5-Pack
S44-4614-BR	S44-4614-BR-R	Brushed	Each
S44-4614-BR-5p	--	Brushed	5-Pack

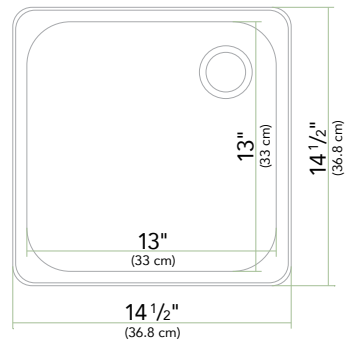

Rectangle Stainless Steel Sink

- Depth: 9 3/4"
- Outside dimensions: 14 1/2" x 14 1/2"
- Bowl dimensions: 13" x 13"
- 304 stainless steel, heavy gauge
- Passivated
- SoundKOTE®- Noise Reduction Technology
- Over- or under-counter mount
- Fits 2" drains, sold separately

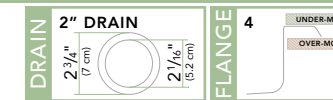

OEM #	Aftermarket #	Finish	Package Type
S44-4914-UM	S44-4914-UM-R	Ultra-Mirror	Each
S44-4914-UM-5p	--	Ultra-Mirror	5-Pack
S44-4914-BR	S44-4914-BR-R	Brushed	Each
S44-4914-BR-5p	--	Brushed	5-Pack

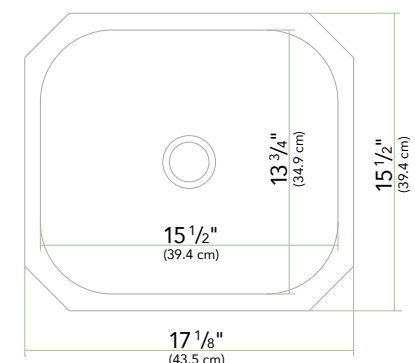

Rectangle Stainless Steel Sink

- Depth: 7 1/2"
- Outside dimensions: 17 1/8" x 15 1/2"
- Bowl dimensions: 15 1/2" x 13 3/4"
- 304 stainless steel, heavy gauge
- Passivated
- Super-SoundKOTE®- Noise Reduction Technology
- Under-counter mount only
- Fits 2" drains, sold separately

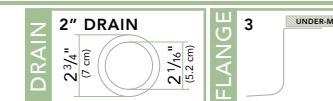

OEM #	Aftermarket #	Finish	Package Type
S43-1718-BR∞	S43-1718-BR-R∞	Brushed	Each

Drains

sold separately (see pages 57-62)



Under-Mount Sink Brackets

optional for solid surfaces or stone counters
sold separately (see page 62)



OEM # - Not Labeled Or Packaged For Resale Aftermarket # - Labeled And Packaged For Resale NOTE: Dimension Drawings ±1/16" (for reference only - may not be to scale)

STAINLESS STEEL SINKS

MARINE GRADE

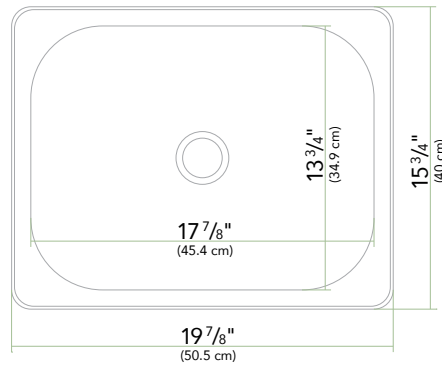

Rectangle Stainless Steel Sink

- Depth: 7 1/2"
- Outside dimensions: 19 7/8" x 15 3/4"
- Bowl dimensions: 17 7/8" x 13 3/4"
- 304 stainless steel, heavy gauge
- Passivated
- SoundKOTE®- Noise Reduction Technology
- Over- or under-counter mount
- Fits 2" drains, sold separately



OEM #	Aftermarket #	Finish	Package Type
S44-1732-BR	S44-1732-BR-R	Brushed	Each
S44-1732-BR-5p	--	Brushed	5-Pack



ALBEMARLE 36 EXPRESS
FEATURING STASIS™ HEAD FAUCET# 132-0100-CP
& STAINLESS STEEL SINK# S67-6515-BR

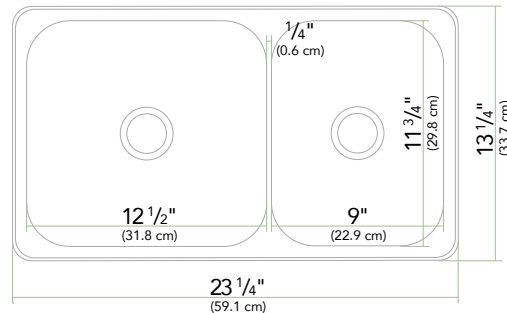
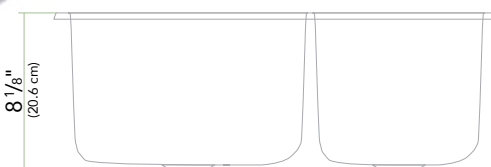

Double Rectangle Stainless Steel Sink

- Depth: 8 1/8"
- Outside dimensions: 23 1/4" x 13 1/4"
- Bowl dimensions: 12 1/2" x 11 3/4" + 9" x 11 3/4"
- 304 stainless steel, heavy gauge
- Passivated
- SoundKOTE®- Noise Reduction Technology
- Over- or under-counter mount
- Fits 2" drains, sold separately



OEM #	Aftermarket #	Finish	Package Type
S54-1823-UM	S54-1823-UM-R	Ultra-Mirror	Each
S54-1823-UM-5p	--	Ultra-Mirror	5-Pack

Drains

sold separately (see pages 57-62)



Under-Mount Sink Brackets

optional for solid surfaces or stone counters
sold separately (see page 62)



OEM # - Not Labeled Or Packaged For Resale Aftermarket # - Labeled And Packaged For Resale NOTE: Dimension Drawings ±1/8" (for reference only - may not be to scale)

MARINE GRADE

DRAINS - 1 3/4"

Our 1 3/4" Drains are made from heavy duty plastic and/or brass and are available in a wide variety of configurations and finishes, to match our sinks and your décor.

Most vessel sinks use a 1 3/4" drain and are generally used as head sinks. 1 3/4" drains are the standard size drain for vessel sinks in North America and Europe.

If you need a configuration that is not shown, ask your sales representative for options.
Minimum annual commitment and additional lead-time may be required for non-standard configurations.

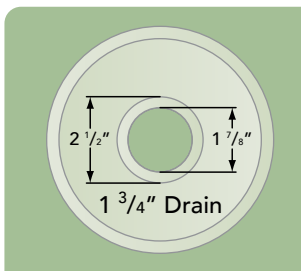

1 3/4" Touch Drain

With 1 1/4"-M Thread

- Tap to open/close
- All brass
- Connection: 1 1/4"-M thread

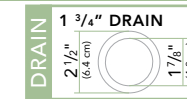

OEM #	Aftermarket #	Finish	Overflow Intake	Connection
V03-0704-CP	V03-0704-CP-R	Chrome	No	1 1/4"-M Thread
V03-0704-NP	V03-0704-NP-R	Brushed Nickel	No	1 1/4"-M Thread

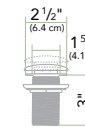

1 3/4" SERIES

1 3/4" Touch / Trap Drain

With 3/4" & 1" Hose Barb

- Tap to open/close
- Easy trap access
- All brass top
- Connection: 3/4" & 1" hose barb

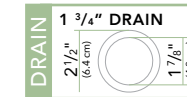

OEM #	Aftermarket #	Finish	Overflow Intake	Connection
V03-0708-CP	V03-0708-CP-R	Chrome	No	3/4" & 1" Hose Barb
V03-0708-NP	V03-0708-NP-R	Brushed Nickel	No	3/4" & 1" Hose Barb

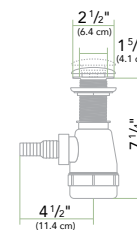

1 3/4" SERIES

1 3/4" Touch / Trap Drain

With 1 1/4" & 1 1/2" Hose Barb

- Tap to open/close
- Easy trap access
- All brass top
- Connection: 1 1/4" & 1 1/2" hose barb

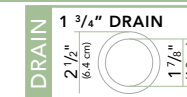

OEM #	Aftermarket #	Finish	Overflow Intake	Connection
V03-0709-CP	V03-0709-CP-R	Chrome	No	1 1/4" & 1 1/2" Hose Barb
V03-0709-NP	V03-0709-NP-R	Brushed Nickel	No	1 1/4" & 1 1/2" Hose Barb

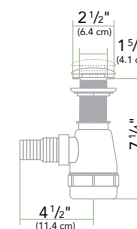

1 3/4" SERIES

1 3/4" Touch / Trap Drain

With 1 1/4"-M Thread

- Tap to open/close
- Easy trap access
- All brass top
- Connection: 1 1/4"-M thread



OEM #	Aftermarket #	Finish	Overflow Intake	Connection
V03-0716-CP	V03-0716-CP-R	Chrome	No	1 1/4"-M Thread
V03-0716-NP	V03-0716-NP-R	Brushed Nickel	No	1 1/4"-M Thread

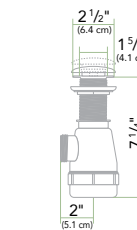

1 3/4" SERIES

OEM # - Not Labeled Or Packaged For Resale Aftermarket # - Labeled And Packaged For Resale NOTE: Dimension Drawings ±1/8" (for reference only - may not be to scale)

DRAINS – 1 1/2"

MARINE GRADE

Our 1 1/2" Drains are made from heavy duty plastic, brass and/or stainless steel and are available in a wide variety of configurations and finishes, to match our sinks and your décor.

Sinks with 1 1/2" drains are generally used as head sinks. 1 1/2" drains are the standard size drain for lavatory sinks in North America.

If you need a configuration that is not shown, ask your sales representative for options. Minimum annual commitment and additional lead-time may be required for non-standard configurations.

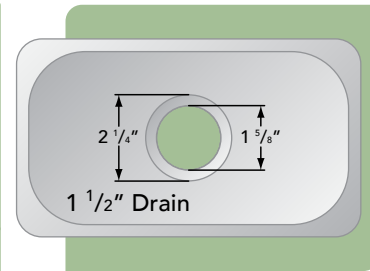

1 1/2" 95° Elbow Drain

With 1" Hose Barb

- Low profile
- Chain stopper
- Finished stainless steel flange to match sink finish
- Connection: 1" hose barb

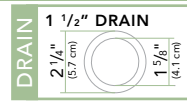

OEM #	Aftermarket #	Finish	Overflow Intake	Connection
S01-0101-UP	S01-0101-UP-R	Ultra-Mirror	--	1" Hose Barb
S01-0101-BP	S01-0101-BP-R	Brushed	--	1" Hose Barb



1 1/2" Straight Drain

With 1 1/4"-M Thread

- Low profile
- Chain stopper
- Finished stainless steel flange to match sink finish
- Connection: 1 1/4"-M thread

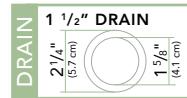

OEM #	Aftermarket #	Finish	Overflow Intake	Connection
S01-0104-UP	S01-0104-UP-R	Ultra-Mirror	--	1 1/4"-M Thread
S01-0104-BP	S01-0104-BP-R	Brushed	--	1 1/4"-M Thread



1 1/2" Flip Drain

With 1 1/4"-M Thread

- Low profile
- Flip to open/close
- With or without overflow intake
- All brass
- Connection: 1 1/4"-M thread

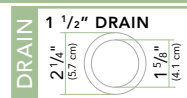

OEM #	Aftermarket #	Finish	Overflow Intake	Connection
S01-0304-CP	S01-0304-CP-R	Chrome	No	1 1/4"-M Thread
S01-0504-CP	S01-0504-CP-R	Chrome	Yes	1 1/4"-M Thread
S01-0304-NP	S01-0304-NP-R	Brushed Nickel	No	1 1/4"-M Thread
S01-0504-NP	S01-0504-NP-R	Brushed Nickel	Yes	1 1/4"-M Thread



1 1/2" Flip Drain

With 1 1/4"-M Sweat

- Flip to open/close
- With or without overflow intake
- All brass
- Connection: 1 1/4"-M sweat fitting

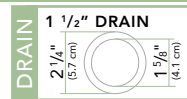

OEM #	Aftermarket #	Finish	Overflow Intake	Connection
S01-0311-CP	S01-0311-CP-R	Chrome	No	1 1/4"-M Sweat
S01-0511-CP	S01-0511-CP-R	Chrome	Yes	1 1/4"-M Sweat
S01-0311-NP	S01-0311-NP-R	Brushed Nickel	No	1 1/4"-M Sweat
S01-0511-NP	S01-0511-NP-R	Brushed Nickel	Yes	1 1/4"-M Sweat

1 1/2" SERIES

1 1/2" SERIES

1 1/2" SERIES

1 1/2" SERIES

OEM # – Not Labeled Or Packaged For Resale Aftermarket # – Labeled And Packaged For Resale NOTE: Dimension Drawings ±1/16" (for reference only – may not be to scale)

MARINE GRADE

DRAINS – 1 1/2"



1 1/2" Flip / Trap Drain

With 3/4" & 1" Hose Barb

- Flip to open/close
- With or without overflow intake
- Easy trap access
- All brass top
- Connection: 3/4" & 1" hose barb

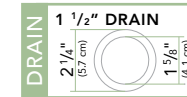

OEM #	Aftermarket #	Finish	Overflow Intake	Connection
S01-0308-CP	S01-0308-CP-R	Chrome	No	3/4" & 1" Hose Barb
S01-0508-CP	S01-0508-CP-R	Chrome	Yes	3/4" & 1" Hose Barb
S01-0308-NP	S01-0308-NP-R	Brushed Nickel	No	3/4" & 1" Hose Barb
S01-0508-NP	S01-0508-NP-R	Brushed Nickel	Yes	3/4" & 1" Hose Barb

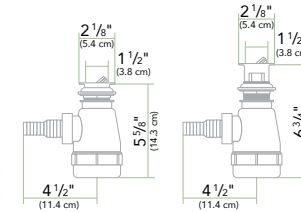

1 1/2" SERIES



1 1/2" Flip / Trap Drain

With 1 1/4" & 1 1/2" Hose Barb

- Flip to open/close
- With or without overflow intake
- Easy trap access
- All brass top
- Connection: 1 1/4" & 1 1/2" hose barb



OEM #	Aftermarket #	Finish	Overflow Intake	Connection
S01-0309-CP	S01-0309-CP-R	Chrome	No	1 1/4" & 1 1/2" Hose Barb
S01-0509-CP	S01-0509-CP-R	Chrome	Yes	1 1/4" & 1 1/2" Hose Barb
S01-0309-NP	S01-0309-NP-R	Brushed Nickel	No	1 1/4" & 1 1/2" Hose Barb
S01-0509-NP	S01-0509-NP-R	Brushed Nickel	Yes	1 1/4" & 1 1/2" Hose Barb

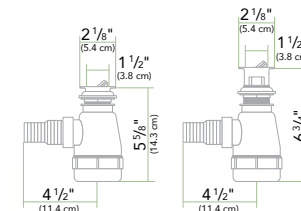

1 1/2" SERIES



1 1/2" Flip / Trap Drain

With 1 1/4"-M Thread

- Flip to open/close
- With or without overflow intake
- Easy trap access
- All brass top
- Connection: 1 1/4"-M thread

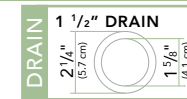

OEM #	Aftermarket #	Finish	Overflow Intake	Connection
S01-0316-CP	S01-0316-CP-R	Chrome	No	1 1/4"-M Thread
S01-0516-CP	S01-0516-CP-R	Chrome	Yes	1 1/4"-M Thread
S01-0316-NP	S01-0316-NP-R	Brushed Nickel	No	1 1/4"-M Thread
S01-0516-NP	S01-0516-NP-R	Brushed Nickel	Yes	1 1/4"-M Thread

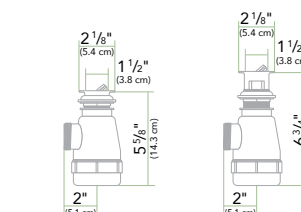

1 1/2" SERIES



SPORTSMAN OPEN 282
FEATURING AIDACK™ ELITE FOLDING TAP# 132-1739-CP

OEM # – Not Labeled Or Packaged For Resale Aftermarket # – Labeled And Packaged For Resale NOTE: Dimension Drawings ±1/16" (for reference only – may not be to scale)

DRAINS – 2"

MARINE GRADE

Our 2" Drains are made from heavy duty plastic and stainless steel and are available in a wide variety of configurations and finishes, to match our sinks and your décor.

Sinks with 2" drains can be used as galley or head sinks. This is the standard size for most sinks in Europe and the rest of the world.

If you need a configuration that is not shown, ask your sales representative for options. Minimum annual commitment and additional lead-time may be required for non-standard configurations.

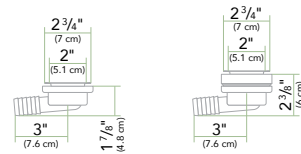
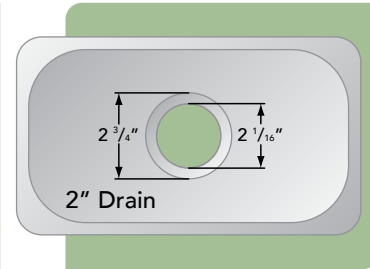

2" 95° Elbow Drain With 1" Hose Barb

- Low profile
- Chain stopper
- With or without stainless steel lift-out basket
- Finished stainless steel flange to match sink finish
- Connection: 1" hose barb

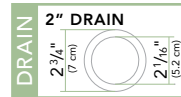

OEM #	Aftermarket #	Finish	Strainer Basket	Connection
S00-0101-UP	S00-0101-UP-R	Ultra-Mirror	No	1" Hose Barb
S00-1102-UP	S00-1102-UP-R	Ultra-Mirror	Yes	1" Hose Barb
S00-0101-BP	S00-0101-BP-R	Brushed	No	1" Hose Barb
S00-1102-BP	S00-1102-BP-R	Brushed	Yes	1" Hose Barb

2" SERIES

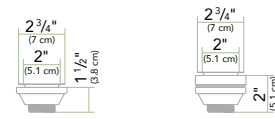

2" Straight Drain With 1 1/4"-M Thread

- Low profile
- Chain stopper
- With or without stainless steel lift-out basket
- Finished stainless steel flange to match sink finish
- Connection: 1 1/4"-M thread

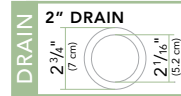

OEM #	Aftermarket #	Finish	Strainer Basket	Connection
S00-0104-UP	S00-0104-UP-R	Ultra-Mirror	No	1 1/4"-M Thread
S00-1104-UP	S00-1104-UP-R	Ultra-Mirror	Yes	1 1/4"-M Thread
S00-0104-BP	S00-0104-BP-R	Brushed	No	1 1/4"-M Thread
S00-1104-BP	S00-1104-BP-R	Brushed	Yes	1 1/4"-M Thread

2" SERIES

2" 95° Elbow Floor Drain With 1" Hose Barb

- Flush mount
- Low profile
- Finished stainless steel flange
- Connection: 1" hose barb

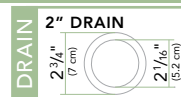

OEM #	Aftermarket #	Finish	Strainer Basket	Connection
S00-0003-UP	S00-0003-UP-R	Ultra-Mirror	--	1" Hose Barb
S00-0003-BP	S00-0003-BP-R	Brushed	--	1" Hose Barb

2" SERIES

OEM # – Not Labeled Or Packaged For Resale Aftermarket # – Labeled And Packaged For Resale NOTE: Dimension Drawings ±1/16" (for reference only – may not be to scale)

MARINE GRADE

DRAINS – 2"

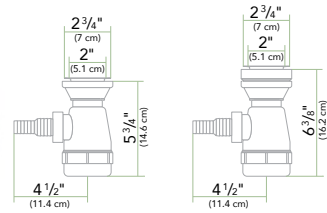

2" Trap Drain With 3/4" & 1" Hose Barb

- Chain stopper
- With or without stainless steel lift-out basket
- Easy trap access
- Finished stainless steel flange to match sink finish
- Connection: 3/4" & 1" hose barb

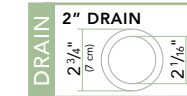

OEM #	Aftermarket #	Finish	Strainer Basket	Connection
S00-0108-UP	S00-0108-UP-R	Ultra-Mirror	No	3/4" & 1" Hose Barb
S00-1108-UP	S00-1108-UP-R	Ultra-Mirror	Yes	3/4" & 1" Hose Barb
S00-0108-BP	S00-0108-BP-R	Brushed	No	3/4" & 1" Hose Barb
S00-1108-BP	S00-1108-BP-R	Brushed	Yes	3/4" & 1" Hose Barb

2" SERIES

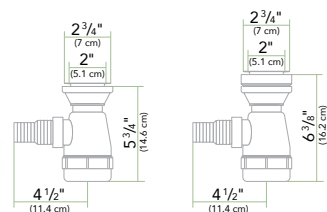

2" Trap Drain With 1 1/4" & 1 1/2" Hose Barb

- Chain stopper
- With or without stainless steel lift-out basket
- Easy trap access
- Finished stainless steel flange to match sink finish
- Connection: 1 1/4" & 1 1/2" hose barb

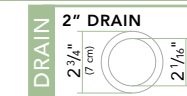

OEM #	Aftermarket #	Finish	Strainer Basket	Connection
S00-0109-UP	S00-0109-UP-R	Ultra-Mirror	No	1 1/4" & 1 1/2" Hose Barb
S00-1109-UP	S00-1109-UP-R	Ultra-Mirror	Yes	1 1/4" & 1 1/2" Hose Barb
S00-0109-BP	S00-0109-BP-R	Brushed	No	1 1/4" & 1 1/2" Hose Barb
S00-1109-BP	S00-1109-BP-R	Brushed	Yes	1 1/4" & 1 1/2" Hose Barb

2" SERIES

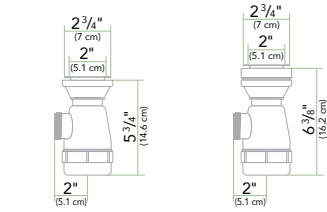

2" Trap Drain With 1 1/4"-M Thread

- Chain stopper
- With or without stainless steel lift-out basket
- Easy trap access
- Finished stainless steel flange to match sink finish
- Connection: 1 1/4"-M thread



OEM #	Aftermarket #	Finish	Strainer Basket	Connection
S00-0116-UP	S00-0116-UP-R	Ultra-Mirror	No	1 1/4"-M Thread
S00-1116-UP	S00-1116-UP-R	Ultra-Mirror	Yes	1 1/4"-M Thread
S00-0116-BP	S00-0116-BP-R	Brushed	No	1 1/4"-M Thread
S00-1116-BP	S00-1116-BP-R	Brushed	Yes	1 1/4"-M Thread

2" SERIES

OEM # – Not Labeled Or Packaged For Resale Aftermarket # – Labeled And Packaged For Resale NOTE: Dimension Drawings ±1/16" (for reference only – may not be to scale)

Glass Vessel Mounting Base (Optional)

- Optional— for use with glass vessel sinks
- Lifts sink 1/2" off counter top
- Solid brass
- For use with 1 3/4" drains



OEM #	Aftermarket #	Finish
V03-0050-CP	V03-0050-CP-R	Chrome
V03-0050-NP	V03-0050-NP-R	Brushed Nickel

Under-Mount Sink Bracket (Optional)

- Optional— for use with any under-mount stainless steel sink installation
- Requires solid surface or stone counter top
- All stainless steel



OEM #	Aftermarket #	Finish	Package Type
S00-0040-SS	--	Stainless Steel	Each
S00-0044-SS	S00-0044-SS-R	Stainless Steel	4-Pack

Hose Barb Adapters

- Sized to fit true 3/4", 1", 1 1/4" and/or 1 1/2" – US standard hoses
- Fits standard 1 1/4"-M thread drain fittings
- Heavy duty plastic
- Use with hose clamp (not included)
- Connection: 1 1/4"-F thread

OEM #	Aftermarket #	Finish	Type	Connection	Barb
S00-0020-PL	S00-0020-PL-R	Gray	Straight	1 1/4"-F Thread	3/4" & 1" Hose
S00-0021-PL	S00-0021-PL-R	Gray	Straight	1 1/4"-F Thread	1 1/4" & 1 1/2" Hose
S00-0022-PL	S00-0022-PL-R	Gray	90° Elbow	1 1/4"-F Thread	3/4" & 1" Hose

Trap Drain Body

- Fits standard 1 1/4"-M threaded drain fittings
- Side port connects to all Ambassador Marine Hose Barb Adapters or any standard 1 1/4"-F threaded waste line
- Easy trap access
- Heavy duty plastic



OEM #	Aftermarket #	Finish	Top Port	Side Port
S00-0016-PL	S00-0016-PL-R	Gray	1 1/4"-F Thread	1 1/4"-M Thread

In-Drain Accessories

- Replacements for items included with Ambassador Marine drains

OEM #	Aftermarket #	Finish	Item	Drain Series
S00-1010-SS	S00-1010-SS-R	Stainless Steel	Lift-Out Strainer Basket	2" Drains
S00-0110-UP	S00-0110-UP-R	Ultra-Mirror	Chain Stopper	2" Drains
S01-0110-PS	S01-0110-PS-R	Black	Chain Stopper	1 1/2" Drains

OEM # – Not Labeled Or Packaged For Resale Aftermarket # – Labeled And Packaged For Resale NOTE: Dimension Drawings ± 1/16" (for reference only – may not be to scale)

We have thousands of replacement parts available to meet your needs and your customers' needs. To identify and request any needed replacement parts, contact our customer service department at 800.270.4262 or info@ambassadormarine.com



LIMITED WARRANTY

Ambassador Marine faucets, sprayers, shower, drains and accessories are guaranteed to be free from material and workmanship defects under normal use and service for a period of five (5) years from the date of purchase. Proof of purchase is required for any and all warranty claims.

Ambassador Marine sinks are guaranteed to be free from material and workmanship defects under normal use and service for a period of one (1) year from the date of purchase. Proof of purchase is required for any and all warranty claims.

This warranty will not apply to products that were improperly installed, misapplied or incompatible with components not manufactured by Ambassador. Failures due to foreign debris are not covered under the terms of this limited warranty. Ambassador will not warrant any product that is physically damaged, neglected or altered outside the Ambassador factory.

Do not attempt to clean your Ambassador product with any kind of chemical or abrasive cleaner. Any abrasive will mar the finish and void the warranty. Do not leave your Ambassador product exposed to salt air without cleaning it regularly with fresh water, after every exposure or use.

All authorized returns are to be shipped postage prepaid to Ambassador Marine's service center. A Return Authorization Number is required and must be clearly visible on the shipping carton. Package all returns carefully. Ambassador will not be responsible for freight damage incurred during shipping to our service center.

No credit or payment will be issued or allowed to consumers on any item deemed defective. Ambassador Marine's total obligation is limited to the repair or replacement of the defective item only, at Ambassador Marine's sole discretion. All returns will be examined and/or tested under Ambassador Marine test criteria. Replacements will be shipped freight prepaid. Products found by Ambassador to NOT be defective (under the terms of this limited warranty) are subject to charges to be paid by the returnee for the testing and packaging of "tested good" items and may be returned only at returnee's expense. Further damage may occur due to testing and is not the responsibility of Ambassador.

In no event will Ambassador, its affiliated companies or agents be responsible for any labor whatsoever, cost of removal or re-installation, incidental and/or consequential damages arising out of the purchase or use of Ambassador products.

This limited warranty is in lieu of, and supersedes all other warranties, expressed or implied, and no other person is authorized to give any other warranty or assume obligation or liability on Ambassador Marine's behalf.

This limited warranty covers Ambassador Marine products sold or distributed in the United States and Canada only. Customers who purchase Ambassador Marine products sold by distributors in other countries must consult their local distributors for their warranty policy.

This warranty gives you certain legal rights which may vary from state to state.

This warranty is only a representation of the complete Ambassador Marine warranty outlined on the Ambassador Marine website.

Ambassador Marine Inc. reserves the right to make product specification changes, price changes and to change or discontinue models without notice or obligation. All spec drawing dimensions ± 1/16", unless noted. Some components may not be drawn to scale. Actual color of product may differ from printed/on-line materials.

TRADE SALES REPRESENTATIVES:

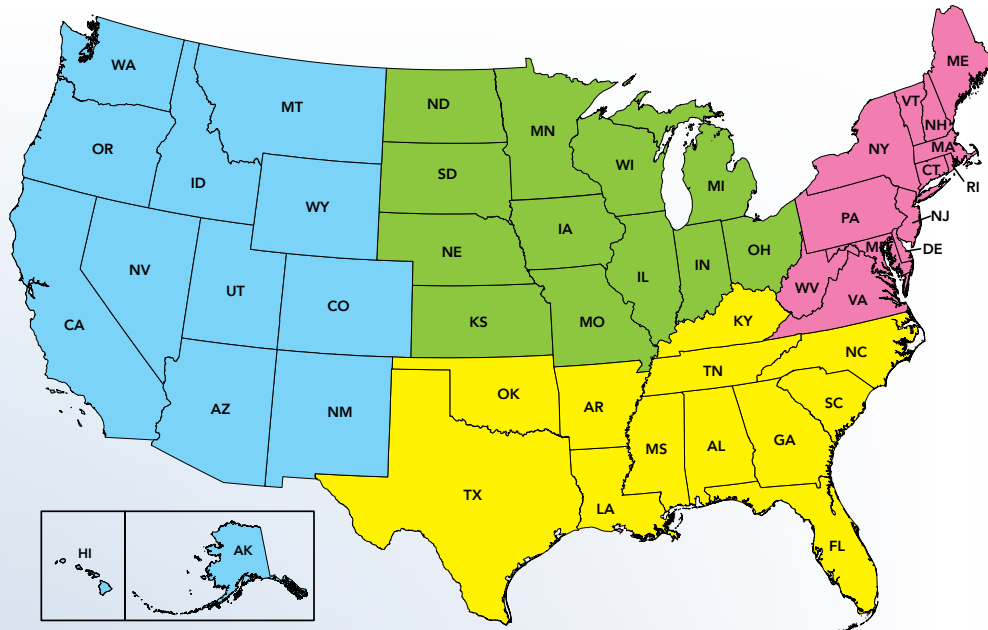

UNITED STATES

GSW AND ASSOCIATES

770.753.1463

Main Office

11807 Northfall Lane #904
Alpharetta, GA 30009 USA

FAX 770.753.1465 • www.gswandassociates.com

MIDWEST OUTDOOR MARKETING

573.317.1103

Main Office

5707 Osage Beach Parkway
Osage Beach, MO 65065 USA
www.momarketing.com

US MARINE MARKETING

843.945.4605

Main Office

1500 Highway 17 N #105
Surfside Beach, SC 29575 USA

FAX 888.203.6494 • www.usmarinemarketing.com

INTERWESTERN SALES

831.884.5105

Main Office

2 Harris Court #A4
Monterey, CA 93940 USA

FAX 831.884.5103 • www.interwesternsales.com

CANADA

INTERWESTERN SALES

831.884.5105

Main Office

2 Harris Court #A4
Monterey, CA 93940 USA

FAX 831.884.5103 • www.interwesternsales.com

CARIBBEAN & LATIN AMERICA

CALA MARINE

305.254.0214

Main Office

13571 SW 135th Avenue #201
Miami, FL 33186 USA

FAX 305.254.0344 • www.cala-marine.com



Ambassador MARINE

...products built for the elements.™

1173 Calle Suerte
Camarillo, California 93012-8052
800.270.4262 • 805.482.0053 • FAX 805.482.0056
www.ambassadormarine.com • info@ambassadormarine.com



COVER PHOTO: STARCRAFT MX Q DC
FEATURING TRINIDAD™ FOLDING TAP# 133-0208-CP
& STAINLESS STEEL SINK# S26-1409-BR

Revised 08/24
© 2024, Ambassador Marine, Inc., All Rights Reserved.