

INSTALLATION INSTRUCTIONS

Thank you for choosing Ambassador Marine.

Your new Ambassador Marine faucet, sprayer, shower or accessory will give you years of trouble-free performance. Please read these instructions carefully before installing your new item. If you have any additional questions about the installation of this product, please feel free to contact one of our friendly customer service representatives at 800.270.4262.

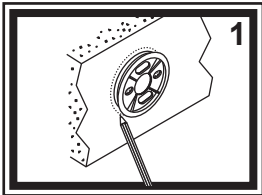
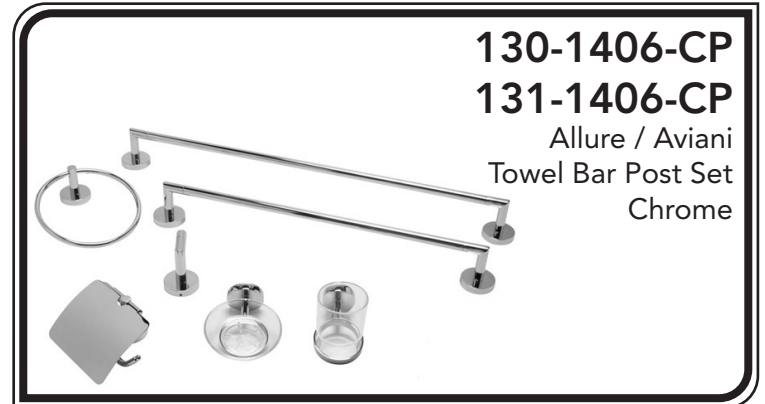

Towel Ring / Robe Hook / Cup Holder / Soap Dish / Single Post TP Holder

1) Hold item on the wall where desired. With a pencil, lightly trace a circle completely around the base of the item. Remove the item. Hold a mounting bracket directly in the center of the outline (see figure 1). Trace a circle around the mounting bracket and the two mounting screw holes.

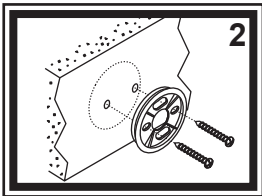

2) Mount the bracket as shown (see figure 2). For mounting into wood, fiberglass, or other solid surface, drill a 1/8" starter hole and attach the bracket to the wall.

3) Secure the item to the bracket (see figure 3) with the set screw pointing down. Tighten the set screw.

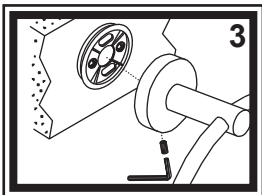

18" Towel Bar / 24" Towel Bar

1) Hold one of the posts on the wall where desired. With a pencil, lightly trace a circle completely around the base of the post. Remove the post. Hold a mounting bracket directly in the center of the outline (see figure 1). Trace a circle around the mounting bracket and the two mounting screw holes.

2) Mount the bracket as shown (see figure 2). For mounting into wood, fiberglass, or other solid surface, drill a 1/8" starter hole and attach the bracket to the wall.

3) Secure the post to the bracket (see figure 3) with the set screw pointing down. Tighten the set screw.

4) For the other end, merely set the bar into the mounted post and hold the other post at the correct spot. NOTE: Mount the second post "in" tightly so that there is no side to side movement of the bar. USE A BUBBLE LEVEL TO INSURE THAT THE BAR IS LEVEL. Trace a circle around the second post (see figure 1) and mount.

Parts

- 1) Mounting Bracket
- 2) Mounting Screws
- 3) Assembly Screw
- 4) Base
- 5) Set Screw
- 6) Body
- 7) O-Ring

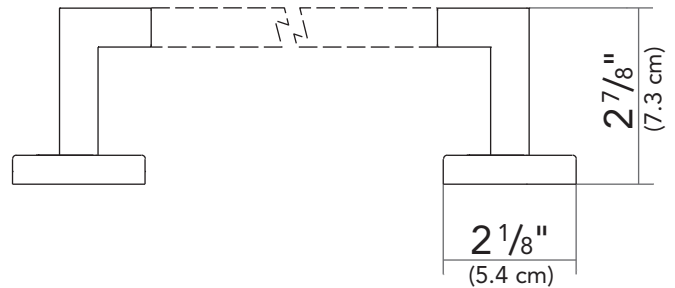
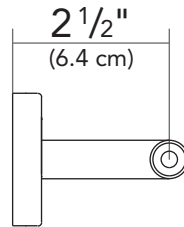
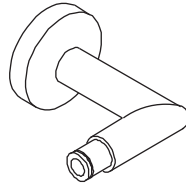
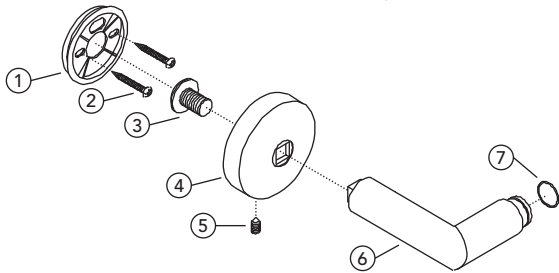

PROPER FINISH CARE

Your new faucet or accessory is protected by a clear-coat. To clean it, you only need to wipe it with a damp, soft cloth. NEVER use any abrasive cleaners, steel wool, or chemicals (including alcohol or ammonia), as they will harm the finish and void your warranty. If the item will be installed in a salt-air environment (boat exterior), regular cleaning with gentle soap and carnauba wax will prolong the life of the finish.

Visit our Web Site at <http://www.ambassadormarine.com>
 Ambassador Marine reserves the right to update specifications, change prices, or make substitutions without notice.

LIMITED WARRANTY

Ambassador Marine faucets and accessories are guaranteed to be free from material and workmanship defects under normal use and service for a period of five (5) years from the date of purchase. This warranty will not apply to faucets or accessories that were improperly installed, misapplied, or incompatible with components not manufactured by Ambassador. Faucet failures due to foreign debris is not covered under the terms of this limited warranty. Ambassador will not warrant any faucet or accessory that is physically damaged, or altered outside the Ambassador factory.

Returns are to be shipped postage prepaid to Ambassador Marine's service center at:
 1090 Lawrence Drive, #103, Newbury Park, CA 91320.

A Return Authorization Number is required and must be clearly visible on the the shipping carton.

Absolutely no credit or payment will be allowed for consumers on any item deemed defective. Ambassador Marine's obligation is limited to the repair or replacement of the defective item only, at Ambassador Marine's sole discretion. All returns will be examined and/or tested under Ambassador Marine test criteria. Replacements will be shipped freight prepaid.

This limited warranty is in lieu of all other warranties, expressed or implied, and no other person is authorized to give any other warranty or assume obligation or liability on Ambassador Marine's behalf. Ambassador Marine shall not be liable for any labor, damages, or other expenses, nor shall Ambassador Marine be liable for any indirect, incidental or consequential damages of any kind incurred by the use or sale of any defective product.

This limited warranty covers Marine Products sold or distributed in the United States and Canada only. Customers who purchase Ambassador Marine products sold by distributors in other countries must consult their local distributors for their warranty policy. This warranty is only a representation of the complete Ambassador Marine warranty outlined on the Ambassador Marine website and/or catalog.