

INSTALLATION INSTRUCTIONS

Thank you for choosing Ambassador Marine.

Your new Ambassador Marine faucet, sprayer, shower or accessory will give you years of trouble-free performance. Please read these instructions carefully before installing your new item. If you have any additional questions about the installation of this product, please feel free to contact one of our friendly customer service representatives at 800.270.4262.

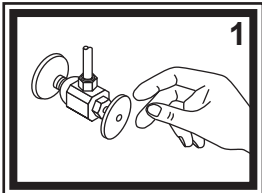

1) Turn off the water supply to your existing faucet (this procedure will vary depending on the specific plumbing system installed on your boat). Cover the sink drain to prevent any small parts or debris from falling in. Remove your existing faucet, taking care not to damage your existing water lines. Clean sink area in preparation for new faucet.

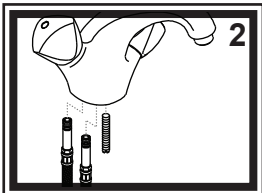

2) Screw mounting bolt into the bottom of the faucet. One end of the bolt is slotted to allow the use of a screwdriver to secure. Screw both connector hoses into the bottom of faucet (note: it is NOT necessary to use Teflon (Plumber's) tape on this connection as the o-rings will prevent leaks). Use a wrench or pliers on the hex nut molded into the brass shaft portion of the hoses. Do NOT attempt to tighten by turning the hose itself.

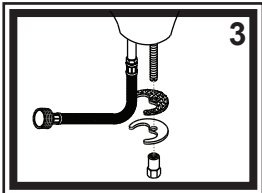

3) Place your new faucet through the hole in your sink. Make sure the black gasket properly lines up with the bottom of the faucet. From under the sink, slide the rubber horseshoe washer then the metal horseshoe washer onto the mounting bolt. Adjust faucet position on the sink as desired. Thread the lock nut onto the mounting bolt and tighten. It may be necessary to re-adjust the faucet position by slightly loosening the lock nut, adjusting to desired location, then re-tightening the lock nut.

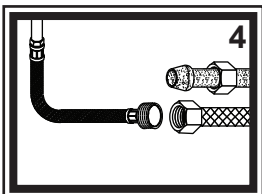

4) Connect water supply lines (not provided) to the connector hoses. Wrap the brass fittings on the connector hoses with Teflon (Plumber's) tape. Follow the appropriate steps depending on your water supply lines. If you have pre-assembled water supply hoses with threaded connectors, simply screw on supply hose. If you have plastic water lines with formed ends, water lines will seat partially up into the brass fittings. Connect by tightening the coupling nuts. We do NOT suggest using sweat fittings as they are prone to blow-outs.

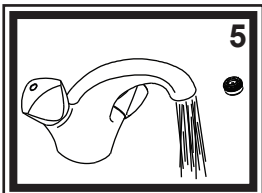

5) After installation is complete, remove the aerator. Be careful not to scratch the finish. Turn the water supply back on and allow both hot and cold water to run for at least one full minute. While water is running, check all connections for leaks. Replace aerator. Connections may need re-tightening.

Parts

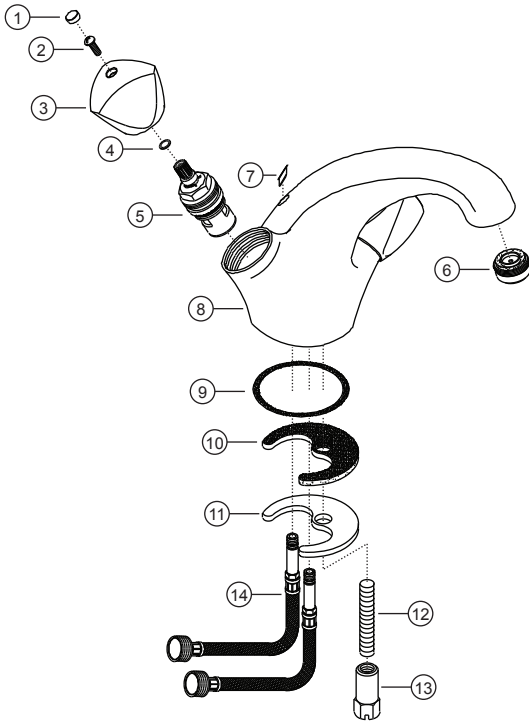

- 1) Blue/Red Cap
- 2) Handle Screw
- 3) Trinidad Handle
- 4) Spacer
- 5) Ceramic Disc Cartridge
- 6) Aerator
- 7) Lift-Rod Hole Plug
- 8) Body
- 9) Gasket
- 10) Rubber Horseshoe Washer
- 11) Metal Horseshoe Washer
- 12) Mounting Bolt
- 13) Lock Nut
- 14) Connector Hoses

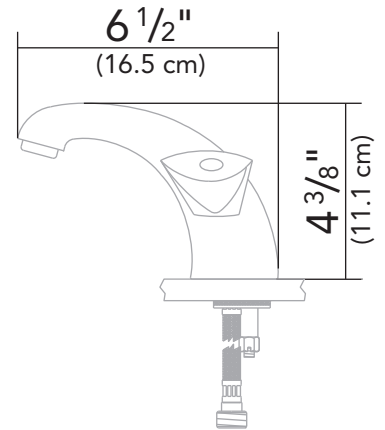
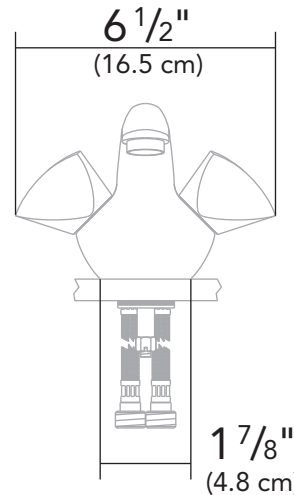

PROPER FINISH CARE

Your new faucet or accessory is protected by a clear-coat. To clean it, you only need to wipe it with a damp, soft cloth. NEVER use any abrasive cleaners, steel wool, or chemicals (including alcohol or ammonia), as they will harm the finish and void your warranty. If the item will be installed in a salt-air environment (boat exterior), regular cleaning with gentle soap and carnauba wax will prolong the life of the finish.

Visit our Web Site at <http://www.ambassadormarine.com>
Ambassador Marine reserves the right to update specifications,
change prices, or make substitutions without notice.

LIMITED WARRANTY

Ambassador Marine faucets and accessories are guaranteed to be free from material and workmanship defects under normal use and service for a period of five (5) years from the date of purchase. This warranty will not apply to faucets or accessories that were improperly installed, misapplied, or incompatible with components not manufactured by Ambassador. Faucet failures due to foreign debris is not covered under the terms of this limited warranty. Ambassador will not warrant any faucet or accessory that is physically damaged, or altered outside the Ambassador factory.

Returns are to be shipped postage prepaid to Ambassador Marine's service center at:
1090 Lawrence Drive, #103, Newbury Park, CA 91320.

A Return Authorization Number is required and must be clearly visible on the shipping carton.

Absolutely no credit or payment will be allowed for consumers on any item deemed defective. Ambassador Marine's obligation is limited to the repair or replacement of the defective item only, at Ambassador Marine's sole discretion. All returns will be examined and/or tested under Ambassador Marine test criteria. Replacements will be shipped freight prepaid.

This limited warranty is in lieu of all other warranties, expressed or implied, and no other person is authorized to give any other warranty or assume obligation or liability on Ambassador Marine's behalf. Ambassador Marine shall not be liable for any labor, damages, or other expenses, nor shall Ambassador Marine be liable for any indirect, incidental or consequential damages of any kind incurred by the use or sale of any defective product.

This limited warranty covers Marine Products sold or distributed in the United States and Canada only. Customers who purchase Ambassador Marine products sold by distributors in other countries must consult their local distributors for their warranty policy. This warranty is only a representation of the complete Ambassador Marine warranty outlined on the Ambassador Marine website and/or catalog.