

INSTALLATION INSTRUCTIONS

Thank you for choosing Ambassador Marine.

Your new Ambassador Marine faucet, sprayer, shower or accessory will give you years of trouble-free performance. Please read these instructions carefully before installing your new item. If you have any additional questions about the installation of this product, please feel free to contact one of our friendly customer service representatives at 800.270.4262.

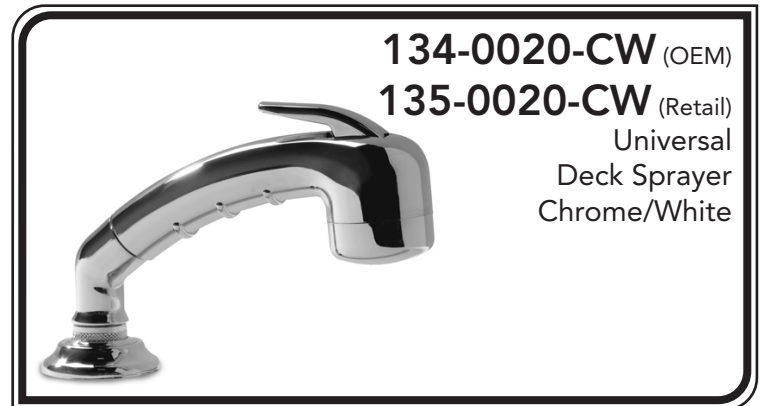

1) Check desired position to make sure there is enough room for the hose to gather under the deck without getting caught on anything. Drill 1" hole in the deck in the desired location.

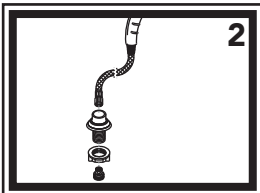

2) Remove hose nest assembly from hose/sprayer assembly. Unscrew 1/2" adapter from hose and pull hose out through the top side of the hose nest shaft. Remove lock nut from hose nest shaft.

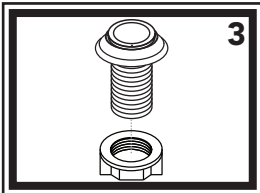

3) Slip hose nest through the hole in the deck. Make sure hose nest collar properly lines up with the hose nest shaft. From under the deck, thread the lock nut onto the hose nest shaft and tighten.

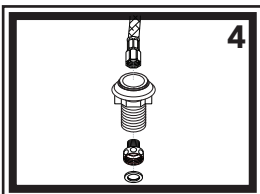

4) Slide hose/sprayer assembly back through the hose nest shaft from above the deck and replace the 1/2" adapter.

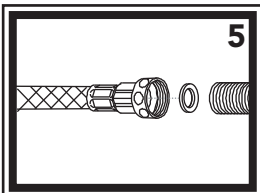

5) Connect to desired 1/2"-Male water source or valve. Make sure the rubber washer is in place in the larger female side of the adapter.

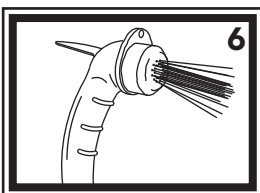

6) This sprayer has two functions: intermittent and continuous. For intermittent spray, simply press down on the trigger. For continuous spray, lift up on the trigger until it locks. To release, simply press the trigger back down. If you wish to add a hook to the sprayer, unscrew the face. Slide the hook onto the sprayer and add the large, black, flat washer inside the face. Replace the face.

Parts

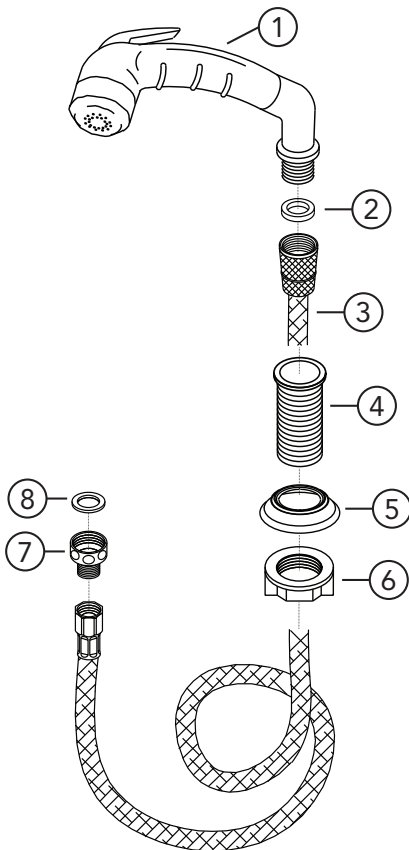

- 1) Small Chrome Sprayer with Elbow (without Hook)
- 2) Washer
- 3) 6' White Rubber Hose
- 4) Hose Nest Shaft
- 5) Hose Nest Collar
- 6) Lock Nut
- 7) 1/2" Adapter
- 8) Washer

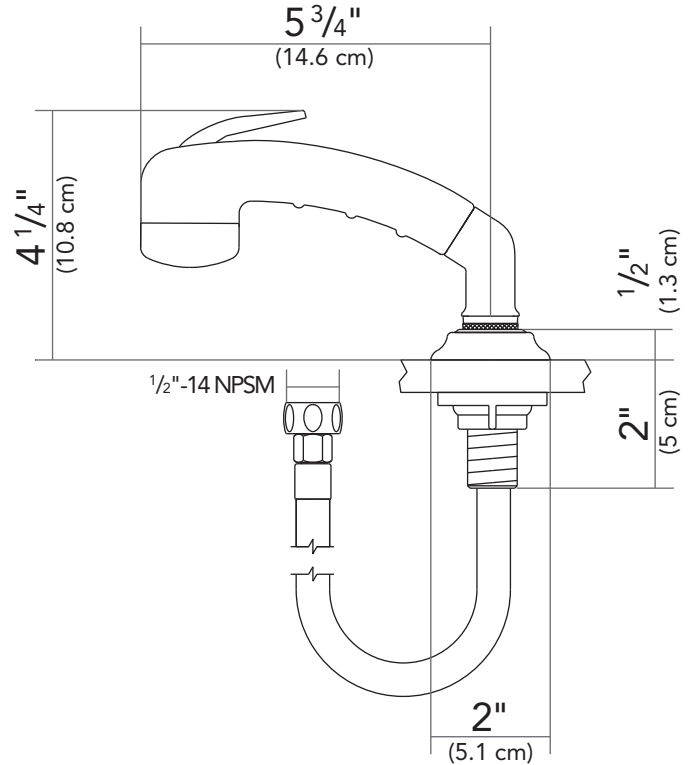

PROPER FINISH CARE

Your new faucet or accessory is protected by a clear-coat. To clean it, you only need to wipe it with a damp, soft cloth. NEVER use any abrasive cleaners, steel wool, or chemicals (including alcohol or ammonia), as they will harm the finish and void your warranty. If the item will be installed in a salt-air environment (boat exterior), regular cleaning with gentle soap and carnauba wax will prolong the life of the finish.

Visit our web site at www.ambassadormarine.com

Ambassador Marine reserves the right to update specifications, change prices, or make substitutions without notice.

LIMITED WARRANTY

Ambassador Marine faucets and accessories are guaranteed to be free from material and workmanship defects under normal use and service for a period of five (5) years from the date of purchase. This warranty will not apply to faucets or accessories that were improperly installed, misapplied, or incompatible with components not manufactured by Ambassador. Faucet failures due to foreign debris is not covered under the terms of this limited warranty. Ambassador will not warrant any faucet or accessory that is physically damaged, or altered outside the Ambassador factory.

Returns are to be shipped postage prepaid to Ambassador Marine's service center at: 1173 Calle Suerte, Camarillo, CA 93012.

A Return Authorization Number is required and must be clearly visible on the shipping carton.

Absolutely no credit or payment will be allowed for consumers on any item deemed defective. Ambassador Marine's obligation is limited to the repair or replacement of the defective item only, at Ambassador Marine's sole discretion. All returns will be examined and/or tested under Ambassador Marine test criteria. Replacements will be shipped freight prepaid.

This limited warranty is in lieu of all other warranties, expressed or implied, and no other person is authorized to give any other warranty or assume obligation or liability on Ambassador Marine's behalf. Ambassador Marine shall not be liable for any labor, damages, or other expenses, nor shall Ambassador Marine be liable for any indirect, incidental or consequential damages of any kind incurred by the use or sale of any defective product.

This limited warranty covers Marine Products sold or distributed in the United States and Canada only. Customers who purchase Ambassador Marine products sold by distributors in other countries must consult their local distributors for their warranty policy. This warranty is only a representation of the complete Ambassador Marine warranty outlined on the Ambassador Marine website and/or catalog.