

INSTALLATION INSTRUCTIONS

Thank you for choosing Ambassador Marine.

Your new Ambassador Marine faucet, sprayer, shower or accessory will give you years of trouble-free performance. Please read these instructions carefully before installing your new item. If you have any additional questions about the installation of this product, please feel free to contact one of our friendly customer service representatives at 800.270.4262.

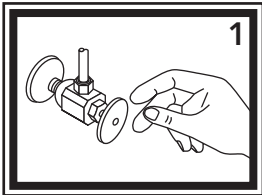

1) Turn off the water supply to your existing faucet (this procedure will vary depending on the specific plumbing system installed on your boat). Cover the drain to prevent any small parts or debris from falling in. Remove your existing faucet, taking care not to damage your existing water lines. Clean area in preparation for new faucet.

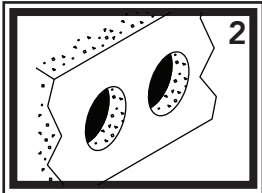

2) Hold valves and bulkhead bracket on the wall where desired. Make sure to leave enough room for your hose to hang freely and extend into the shower. Mark locations on the wall with a pencil. Drill 1" holes in the bulkhead in the desired location for the valves and 1/8" starter holes for the bulkhead bracket screws.

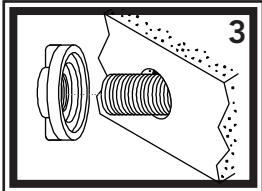

3) Slide valves into holes in the bulkhead. From the back side of the wall attach the lock nuts and tighten. Then attach water source to the 1/2" Male inlets.

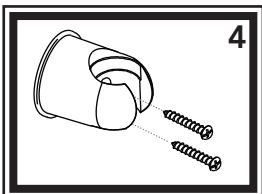

4) Mount bulkhead bracket with the two stainless steel screws provided. The top of the bracket is the side with the larger diameter opening.

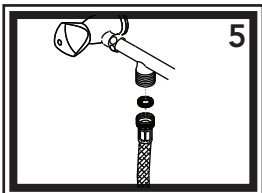

5) Attach hose to connector bar. Make sure black rubber washer is inside the fitting on the hose before attaching.

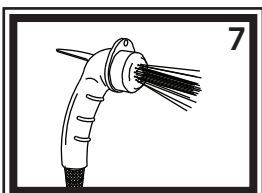

6) Set sprayer in bulkhead bracket. Push down on the sprayer slightly to insure that it is resting securely in the bracket.

7) This sprayer has two functions: intermittent and continuous. For intermittent spray, simply press down on the trigger. For continuous spray, lift up on the trigger until it locks. To release, simply press the trigger back down. If you wish to remove the hook from the sprayer, unscrew the face. Slide the hook ring off the sprayer and remove the large, black, flat washer from inside the face. Replace the face.

Parts

- 1) Blue/Red Cap
- 2) Handle Screw
- 3) Mini Trinidad Handle
- 4) Compression Cartridge
- 5) Body
- 6) Lock Nut
- 7) Bonnet
- 8) O-Ring
- 9) O-Ring
- 10) Connector Bar
- 11) Washer
- 12) 6' Black Rubber Hose
- 13) Mounting Screws
- 14) Bulkhead Holder
- 15) Washer
- 16) Small Black Sprayer w/Hook

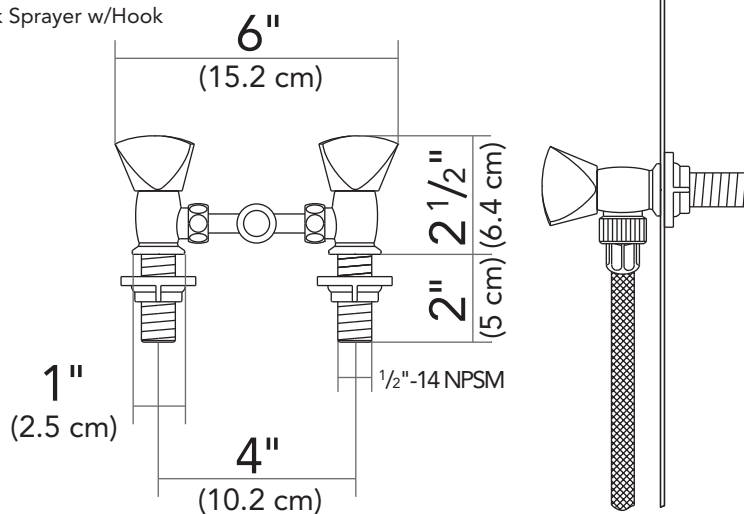
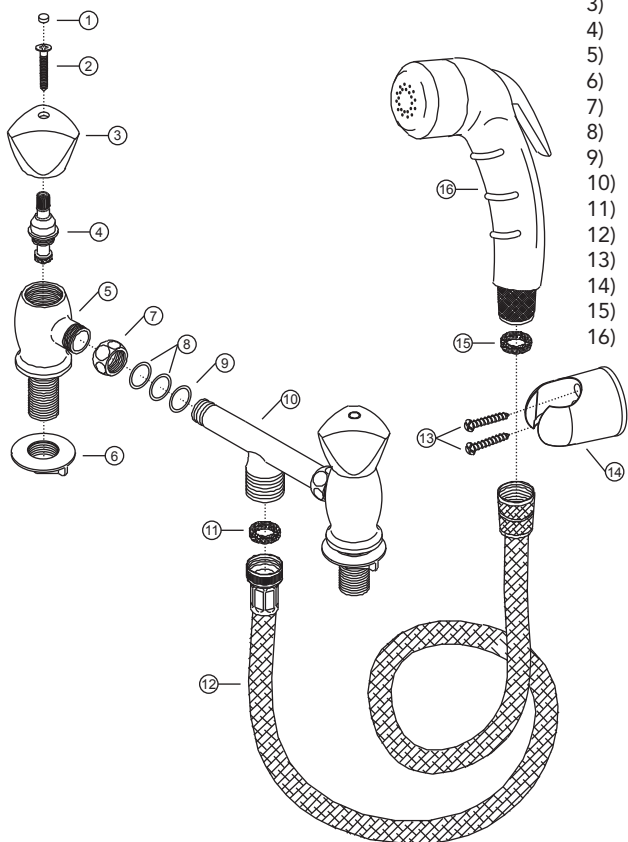

PROPER FINISH CARE

Your new faucet or accessory is protected by a clear-coat. To clean it, you only need to wipe it with a damp, soft cloth. NEVER use any abrasive cleaners, steel wool, or chemicals (including alcohol or ammonia), as they will harm the finish and void your warranty. If the item will be installed in a salt-air environment (boat exterior), regular cleaning with gentle soap and carnauba wax will prolong the life of the finish.

Visit our web site at www.ambassadormarine.com

Ambassador Marine reserves the right to update specifications, change prices, or make substitutions without notice.

LIMITED WARRANTY

Ambassador Marine faucets and accessories are guaranteed to be free from material and workmanship defects under normal use and service for a period of five (5) years from the date of purchase. This warranty will not apply to faucets or accessories that were improperly installed, misapplied, or incompatible with components not manufactured by Ambassador. Faucet failures due to foreign debris is not covered under the terms of this limited warranty. Ambassador will not warrant any faucet or accessory that is physically damaged, or altered outside the Ambassador factory.

Returns are to be shipped postage prepaid to Ambassador Marine's service center at: 1173 Calle Suerte, Camarillo, CA 93012.

A Return Authorization Number is required and must be clearly visible on the the shipping carton.

Absolutely no credit or payment will be allowed for consumers on any item deemed defective. Ambassador Marine's obligation is limited to the repair or replacement of the defective item only, at Ambassador Marine's sole discretion. All returns will be examined and/or tested under Ambassador Marine test criteria. Replacements will be shipped freight prepaid.

This limited warranty is in lieu of all other warranties, expressed or implied, and no other person is authorized to give any other warranty or assume obligation or liability on Ambassador Marine's behalf. Ambassador Marine shall not be liable for any labor, damages, or other expenses, nor shall Ambassador Marine be liable for any indirect, incidental or consequential damages of any kind incurred by the use or sale of any defective product.

This limited warranty covers Marine Products sold or distributed in the United States and Canada only. Customers who purchase Ambassador Marine products sold by distributors in other countries must consult their local distributors for their warranty policy. This warranty is only a representation of the complete Ambassador Marine warranty outlined on the Ambassador Marine website and/or catalog.