

INSTALLATION INSTRUCTIONS

Thank you for choosing Ambassador Marine.

Your new Ambassador Marine faucet, sprayer, shower or accessory will give you years of trouble-free performance. Please read these instructions carefully before installing your new item. If you have any additional questions about the installation of this product, please feel free to contact one of our friendly customer service representatives at 800.270.4262.

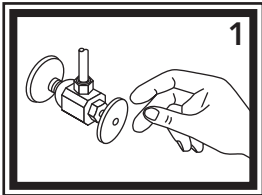
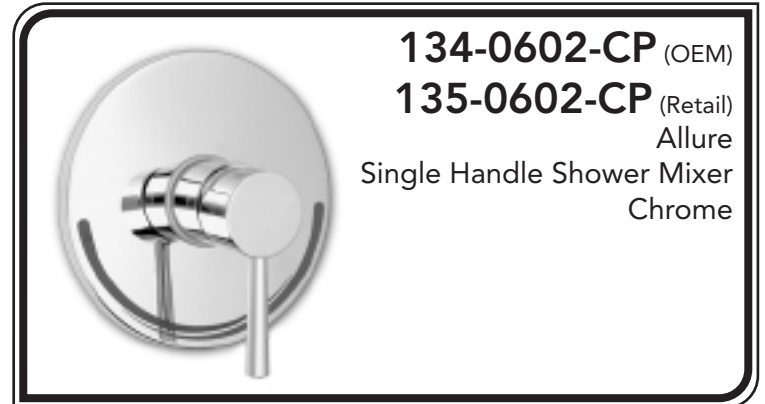

1) Turn off the water supply to your existing faucet (this procedure will vary depending on the specific plumbing system installed on your boat).

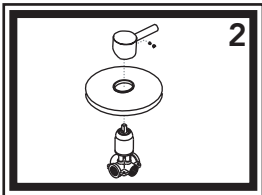

2) Remove handle and wall plate from valve assembly. Remove the blue/red cap and loosen the set screw behind it. Slide handle off the cartridge. Slide wall plate off the trim sleeve. Be careful not to damage the wall plate gasket.

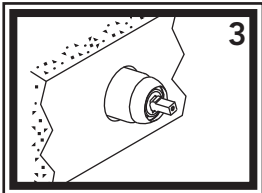

3) From the back side of the bulkhead, slide the valve assembly through the hole in the bulkhead. Note that the brass valve is stamped with "UP". Make sure that the "UP" is on the top side when positioned.

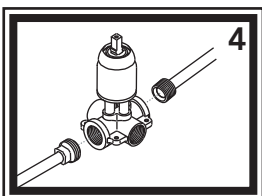

4) Connect hot/cold water supply lines (not provided) to the inlet tubes. The inlet tubes are the 1/2" NPS-Female tubes on the left and right sides of the valve. Wrap the fittings with Teflon (Plumber's) tape. This procedure will vary depending on the specific plumbing system installed on your boat.

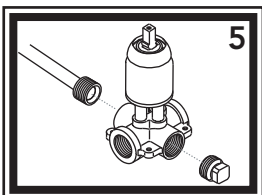

5) Connect 1/2" NPS-Male water line from the shower head or bulkhead elbow (not included) to the shower head (top) port. Wrap the fitting on the water line with Teflon (Plumber's) tape. Thread tub port plug into the tub port (bottom) (if you are not using a tub spout with this installation). Wrap the plug with Teflon (Plumber's) tape.

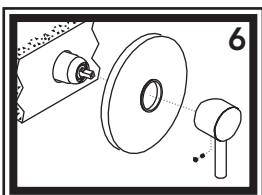

6) Replace handle and wall plate onto valve assembly. Slide wall plate back onto the trim sleeve. Be careful not to damage the wall plate gasket. Tighten the handle screw and replace the blue/red cap. It may be necessary to secure the valve inside the wall to prevent movement. This procedure will vary depending on the specific design of your boat. Suggestions: Use the screw-holes molded into the valve. Use strapping material. Wedge item in place.

7) After installation is complete, turn the water supply back on and allow both hot and cold water to run for at least one full minute. While water is running, check all connections for leaks. Connections may need re-tightening.

Parts

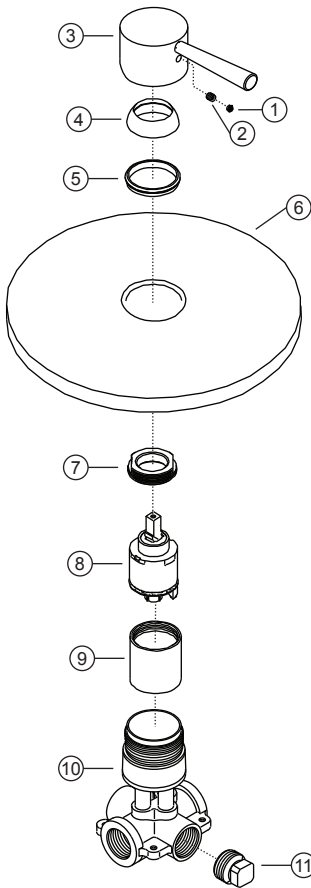

- 1) Blue/Red Cap
- 2) Handle Screw
- 3) Allure Handle
- 4) Cap
- 5) Wall Plate Gasket
- 6) Wall Plate
- 7) Retainer Nut
- 8) Ceramic Disc Cartridge
- 9) Trim Sleeve
- 10) Valve Body
- 11) Tub Spout Port Plug

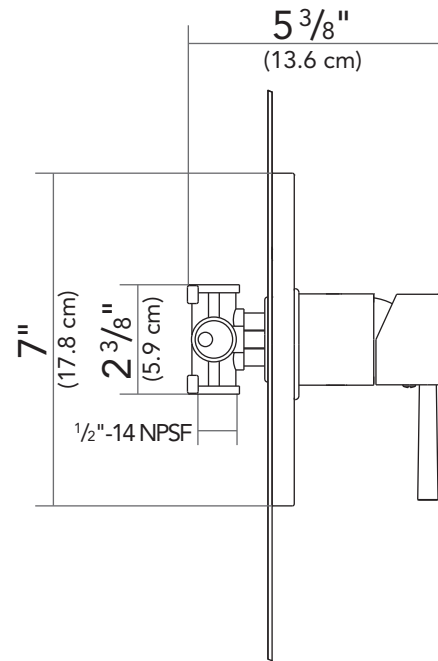

PROPER FINISH CARE

Your new faucet or accessory is protected by a clear-coat. To clean it, you only need to wipe it with a damp, soft cloth. NEVER use any abrasive cleaners, steel wool, or chemicals (including alcohol or ammonia), as they will harm the finish and void your warranty. If the item will be installed in a salt-air environment (boat exterior), regular cleaning with gentle soap and carnauba wax will prolong the life of the finish.

Visit our web site at www.ambassadormarine.com

Ambassador Marine reserves the right to update specifications, change prices, or make substitutions without notice.

LIMITED WARRANTY

Ambassador Marine faucets and accessories are guaranteed to be free from material and workmanship defects under normal use and service for a period of five (5) years from the date of purchase. This warranty will not apply to faucets or accessories that were improperly installed, misapplied, or incompatible with components not manufactured by Ambassador. Faucet failures due to foreign debris is not covered under the terms of this limited warranty. Ambassador will not warrant any faucet or accessory that is physically damaged, or altered outside the Ambassador factory.

Returns are to be shipped postage prepaid to Ambassador Marine's service center at: 1173 Calle Suerte, Camarillo, CA 93012.

A Return Authorization Number is required and must be clearly visible on the shipping carton.

Absolutely no credit or payment will be allowed for consumers on any item deemed defective. Ambassador Marine's obligation is limited to the repair or replacement of the defective item only, at Ambassador Marine's sole discretion. All returns will be examined and/or tested under Ambassador Marine test criteria. Replacements will be shipped freight prepaid.

This limited warranty is in lieu of all other warranties, expressed or implied, and no other person is authorized to give any other warranty or assume obligation or liability on Ambassador Marine's behalf. Ambassador Marine shall not be liable for any labor, damages, or other expenses, nor shall Ambassador Marine be liable for any indirect, incidental or consequential damages of any kind incurred by the use or sale of any defective product.

This limited warranty covers Marine Products sold or distributed in the United States and Canada only. Customers who purchase Ambassador Marine products sold by distributors in other countries must consult their local distributors for their warranty policy. This warranty is only a representation of the complete Ambassador Marine warranty outlined on the Ambassador Marine website and/or catalog.