

INSTALLATION INSTRUCTIONS

Thank you for choosing Ambassador Marine.

Your new Ambassador Marine faucet, sprayer, shower or accessory will give you years of trouble-free performance. Please read these instructions carefully before installing your new item. If you have any additional questions about the installation of this product, please feel free to contact one of our friendly customer service representatives at 800.270.4262.



- 1) Check desired position to make sure there is enough room for the hose to gather under the deck or inside the wall without getting caught on anything. Drill 2 7/8" to 3" hole in the desired location.

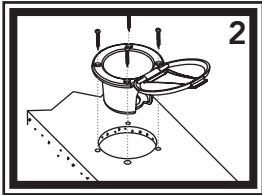

- 2) Place the recessed cup and lid into the hole.

Wall Mount— Place into the hole with the hinge pointing **DOWN**. This will allow the lid to fall out of the way of the hose when in use. Please note: The trigger will stick out through the back hole when the sprayer is resting in the recessed cup. It is important to ensure there is ample clearance for the trigger, in order to prevent accidental discharge. Secure recessed cup and lid using the provided four (4) screws.

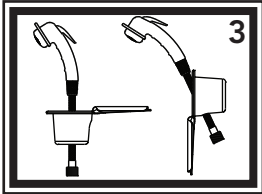

Deck Mount— Place into the hole with the hinge pointing in the desired direction for the lid to easily lay open when in use. Please note: The trigger will stick out through the side hole when the sprayer is resting in the recessed cup. It is important to ensure there is ample clearance for the trigger, in order to prevent accidental discharge. Secure recessed cup and lid using the provided four (4) screws.



- 3) Slide hose/sprayer assembly through the appropriate hole in the recessed cup, as illustrated.

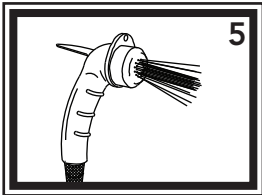

- 4) Connect to desired 1/2"-Male water source or valve. Make sure rubber washer is in place in the female hose fitting.

- 5) This sprayer has two functions: intermittent and continuous. For intermittent spray, simply press down on the trigger. For continuous spray, lift up on the trigger until it locks. To release, simply press the trigger back down.

Parts

- 1) Small Chrome Sprayer
- 2) Washer
- 3) 10' White Rubber Hose
- 4) Washer
- 5) Chrome Plastic Recessed Cup
- 6) Chrome Plastic Lid
- 7) Mounting Screws (4x)

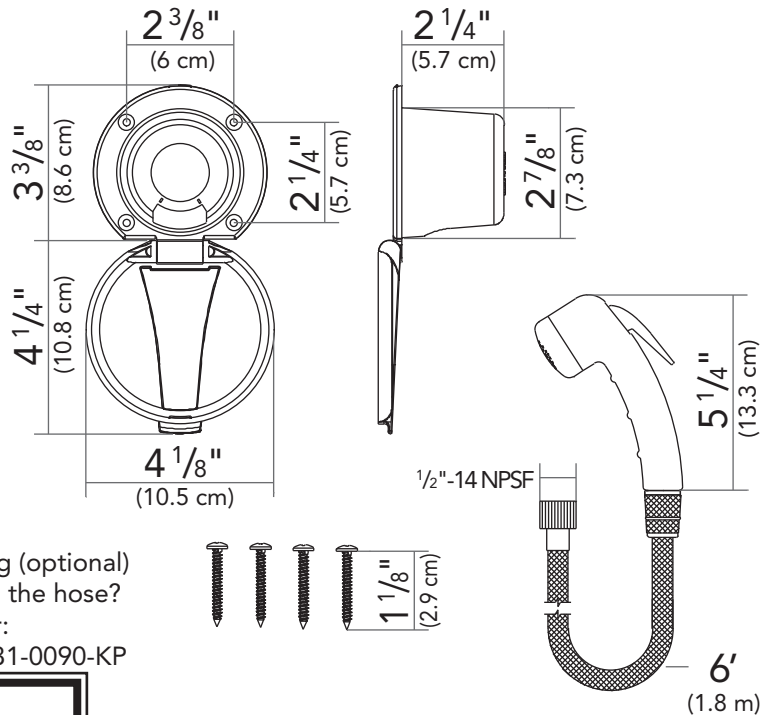
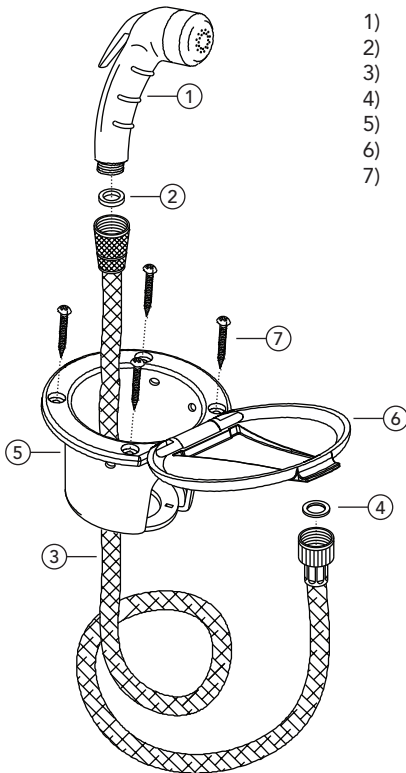

Need our matching (optional)
Mesh Bag to hold the hose?

Ask for:

136-0090-KP or 131-0090-KP

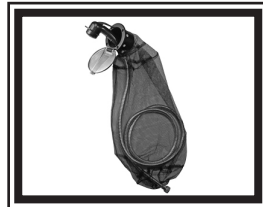

PROPER FINISH CARE

Your new faucet or accessory is protected by a clear-coat. To clean it, you only need to wipe it with a damp, soft cloth. NEVER use any abrasive cleaners, steel wool, or chemicals (including alcohol or ammonia), as they will harm the finish and void your warranty. If the item will be installed in a salt-air environment (boat exterior), regular cleaning with gentle soap and carnauba wax will prolong the life of the finish.

Visit our web site at www.ambassadormarine.com

Ambassador Marine reserves the right to update specifications, change prices, or make substitutions without notice.

LIMITED WARRANTY

Ambassador Marine faucets and accessories are guaranteed to be free from material and workmanship defects under normal use and service for a period of five (5) years from the date of purchase. This warranty will not apply to faucets or accessories that were improperly installed, misapplied, or incompatible with components not manufactured by Ambassador. Faucet failures due to foreign debris is not covered under the terms of this limited warranty. Ambassador will not warrant any faucet or accessory that is physically damaged, or altered outside the Ambassador factory.

Returns are to be shipped postage prepaid to Ambassador Marine's service center at:
1173 Calle Suerte, Camarillo, CA 93012.

A Return Authorization Number is required and must be clearly visible on the shipping carton.

Absolutely no credit or payment will be allowed for consumers on any item deemed defective. Ambassador Marine's obligation is limited to the repair or replacement of the defective item only, at Ambassador Marine's sole discretion. All returns will be examined and/or tested under Ambassador Marine test criteria. Replacements will be shipped freight prepaid.

This limited warranty is in lieu of all other warranties, expressed or implied, and no other person is authorized to give any other warranty or assume obligation or liability on Ambassador Marine's behalf. Ambassador Marine shall not be liable for any labor, damages, or other expenses, nor shall Ambassador Marine be liable for any indirect, incidental or consequential damages of any kind incurred by the use or sale of any defective product.

This limited warranty covers Marine Products sold or distributed in the United States and Canada only. Customers who purchase Ambassador Marine products sold by distributors in other countries must consult their local distributors for their warranty policy. This warranty is only a representation of the complete Ambassador Marine warranty outlined on the Ambassador Marine website and/or catalog.