

## INSTALLATION INSTRUCTIONS

Thank you for choosing Ambassador Marine.

Your new Ambassador Marine faucet, shower, sprayer or accessory will give you years of trouble-free performance. Please read these instructions carefully before installing your new item. If you have any additional questions about the installation of this product, feel free to contact a customer service representative at 1.800.270.4262.

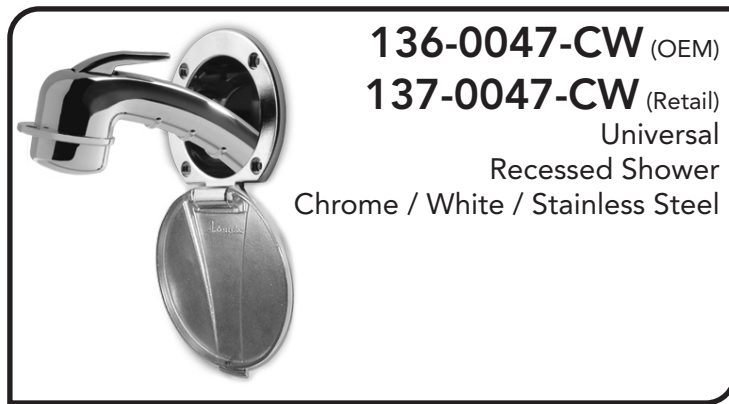

### IF REPLACING AN EXISTING FAUCET:

Turn off the water supply to your existing faucet (this procedure will vary depending on the specific plumbing system installed on your boat). Remove your existing faucet, taking care not to damage your existing water lines. Clean bulkhead (wall) or deck area in preparation for new faucet.

### IF ADDING NEW HOLE TO BULKHEAD/DECK:

See "Installation Hole Requirement" to the right, for this model. Check to ensure there is enough room for the faucet, including necessary supply line(s), pull-out hose, etc. behind the bulkhead (wall) or under the deck. Drill hole, using proper bit for the surface material and diameter.

### Installation Hole Requirement

This unit requires a minimum of this/these hole(s)

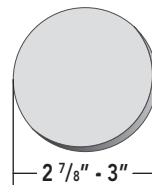

OR

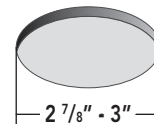

Wall-Mount

Deck-Mount

## INSTALLING YOUR NEW AMBASSADOR MARINE UNIT:

### NEEDED / HELPFUL TOOLS



Safety Glasses



Drill (with Bit)



Adjustable Wrench



Pliers



Plumber's (Teflon) Tape



Clean Rags

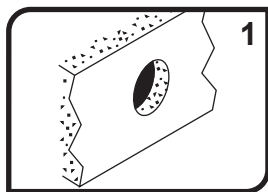

1

1) Check desired position to make sure there is enough room for the hose to gather under the deck or inside the wall without getting kinked or caught on anything. Our option Mesh Bag may help ensure easy use of the hose.

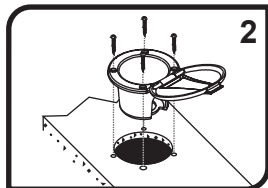

2

2) From the front side of the bulkhead (or above the deck), place the recessed cup and lid through the hole.

**Wall Mount**— Place into the hole with the hinge pointing in the desired direction, either UP or DOWN, not side to side. DOWN is the preferred direction as it will allow the lid to fall out of the way of the hose when in use. Please note: The trigger will stick out through the back hole when the sprayer is resting in the recessed cup. It is important to ensure there is ample clearance for the trigger, in order to prevent accidental discharge. Secure recessed cup and lid using the provided four (4) screws.

**Deck Mount**— Place into the hole with the hinge pointing in the desired direction for the lid to easily lay open when in use. Please note: The trigger will stick out through one of the side holes when the sprayer is resting in the recessed cup. It is important to ensure there is ample clearance for the trigger, in order to prevent accidental discharge. Secure recessed cup and lid using the provided four (4) screws.

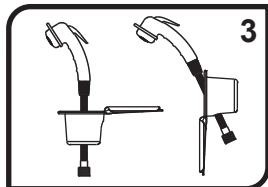

3

3) Attach hose to the sprayer, ensuring the flat 1/2" rubber washer in the hose conical before connecting. Slide hose/sprayer assembly through the appropriate hole in the recessed cup, as illustrated.

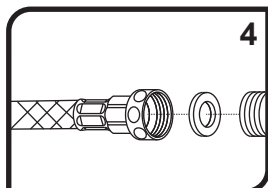

4

4) Connect the hose to desired water source or valve using the remaining 1/2" rubber washer. Water source will vary depending on the specific plumbing system and configuration installed on your boat. To properly connect to the hose, source must be the North American 'STANDARD 1/2" FAUCET' (1/2" NPS\*) male connector. Wrap male fitting with plumber's (Teflon) tape. Follow the appropriate steps depending on your water source. We do NOT suggest using sweat fittings as they are prone to blow-outs. Turn water supply on and allow water to run for at least one full minute. While water is running, check connections for leaks. Connections may need re-tightening.

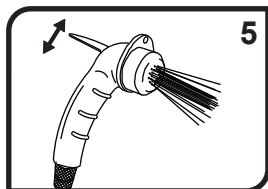

5

5) This sprayer has two functions: intermittent and continuous. For intermittent spray, simply press down on the trigger. For continuous spray, lift up on the trigger until it locks. To release, simply press the trigger back down.

6) The latch tension is adjustable. If you need to make the latch tighter, simply bend the 2 latch prongs in slightly causing a stronger hold. If the latch is too tight, simply bend the 2 latch prongs out slightly allowing a looser hold.

## Parts

- 1) Small Sprayer (with hook)
- 2) 10' Rubber Hose Assembly
  - 2a) Washer
  - 2b) 10' Rubber Hose
  - 2c) Washer
- 3) Recessed Cup & Lid Set (stainless lid / plastic cup)
  - 3a) Mounting Screws
  - 3b) Lid Assembly (w/spring clip latch) (stainless)
    - 3b-1) Lid (w/spring clip latch) (stainless)
    - 3b-2) Hinge Inserts
  - 3c) Recessed Cup (plastic)

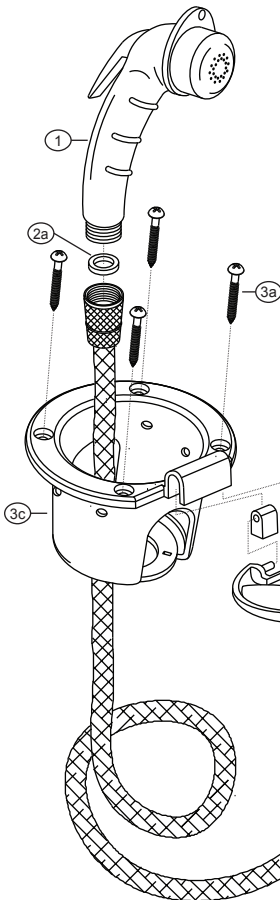

Need the matching  
**Mesh Bag**  
to hold the hose?  
Ask for:  
**137-0090-KP**  
bag is optional



Need the matching  
**Bulkhead  
Sprayer Holder**  
to fit with this  
sprayer? Ask for:  
**131-0042-CP**  
fits standard 1/2" hose conicals



**136-0047-CW** (OEM)

**137-0047-CW** (Retail)

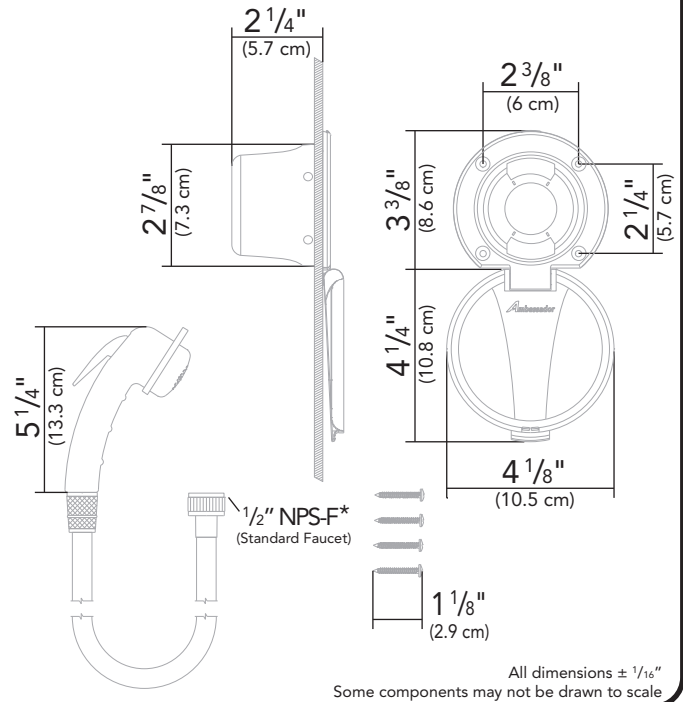

### \* Supply Connection(s) - Understanding NPS vs. NPT

**NPS** = National Pipe Straight

**NPT** = National Pipe Tapered

(-M = Male -F = Female)

Straight Threads (Male)

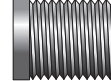

Tapered Threads (Male)

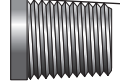

Plumbing fittings are commonly referred to as "NPT", however, in reality, nearly all FAUCETS are actually "NPS". NPS is the North American "STANDARD" for faucets, regardless of brand, style, application, etc. Outside North America, BSP is the most commonly used standard.

Both NPS and NPT have the same thread angle, shape, and pitch (threads per inch). However, NPS threads are straight (parallel) and NPT threads are tapered (reduced).

Straight Pipe thread is commonly found on faucets, showerheads, hose connections and fittings. Tapered Pipe thread is commonly found on pipe ends, nipples and fittings (i.e. couplings, elbows, tees, etc.). Straight Pipe threads need a gasket or o-ring to create a seal. Both styles require sealant or plumber's tape for optimal seal. While NPS and NPT threads will engage, they do not seal properly with each other.

## PROPER FINISH CARE

Your new faucet or accessory is protected by a marine grade finish. To clean it, you only need to wipe it with a damp, soft cloth. NEVER use any abrasive cleaners, steel wool, or chemicals (including alcohol or ammonia), as they will harm the finish and void your warranty. If the item will be installed in a salt-air environment (boat exterior), regular cleaning with gentle soap and carnauba wax will prolong the life of the finish.

## LIMITED WARRANTY

Ambassador Marine faucets and accessories are guaranteed to be free from material and workmanship defects under normal use and service for a period of five (5) years from the date of purchase. This warranty will not apply to faucets or accessories that were improperly installed, misapplied, or incompatible with components not manufactured by Ambassador. Faucet failures due to foreign debris is not covered under the terms of this limited warranty. Ambassador will not warrant any faucet or accessory that is physically damaged, or altered outside the Ambassador factory.

Returns are to be shipped postage prepaid to Ambassador Marine's service center at: Ambassador Marine, 1173 Calle Suerte, Camarillo, CA 93012. A Return Authorization Number is required and must be clearly visible on the shipping carton.

Absolutely no credit or payment will be allowed for consumers on any item deemed defective. Ambassador Marine's obligation is limited to the repair or replacement of the defective item only, at Ambassador Marine's sole discretion. All returns will be examined and/or tested under Ambassador Marine test criteria. Replacements will be shipped freight prepaid.

This limited warranty is in lieu of all other warranties, expressed or implied, and no other person is authorized to give any other warranty or assume obligation or liability on Ambassador Marine's behalf. Ambassador Marine shall not be liable for any labor, damages, or other expenses, nor shall Ambassador Marine be liable for any indirect, incidental or consequential damages of any kind incurred by the use or sale of any defective product.

This limited warranty covers Marine Products sold or distributed in the United States and Canada only. Customers who purchase Ambassador Marine products sold by distributors in other countries must consult their local distributors for their warranty policy. **This warranty is only a representation of the complete Ambassador Marine warranty outlined on the Ambassador Marine website and/or catalog.**



Visit our web site at [www.ambassadormarine.com](http://www.ambassadormarine.com)

Ambassador Marine reserves the right to update specifications, change prices, or make substitutions without notice.

1173 Calle Suerte • Camarillo, CA 93012  
800.270.4262 • 805.482.0053 • Fax 805.482.0056

[www.ambassadormarine.com](http://www.ambassadormarine.com) • [info@ambassadormarine.com](mailto:info@ambassadormarine.com)

Rev. 05/20  
© 2020 Ambassador Marine, Inc., All Rights Reserved