

# SHURflo<sup>®</sup> Marine Grade Faucets

## INSTALLATION INSTRUCTIONS

### OEM Version

**Attention Manufacturers:**  
Please include this Installation  
Instruction sheet with your Owner's  
Documentation.

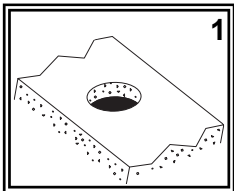

- (1) Check desired position to make sure there is enough room for your hose to gather under the deck without getting caught on anything. Drill 1" hole in the deck in the desired location.

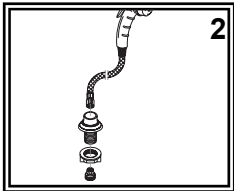

- (2) Remove holder from hose/sprayer assembly. Unscrew 1/2" adapter from hose and pull hose out through the top side of the holder. Remove lock nut from mounting tube.

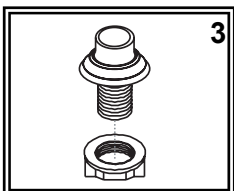

- (3) Slip holder through the hole in the deck. Make sure escutcheon properly lines up with the mounting tube. From the under the deck, thread the lock nut onto the mounting tube and tighten.

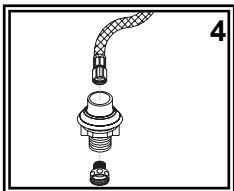

- (4) Slide hose/sprayer assembly back through holder from above the deck and replace the 1/2" adapter.

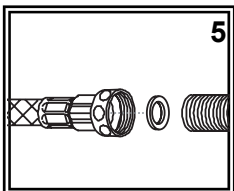

- (5) Connect to desired 1/2" NPT-Male water source or valve. Make sure rubber washer is in place in the larger female side of the adapter.

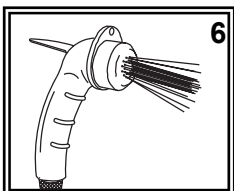

- (6) This sprayer has two functions: intermittent and continuous. For intermittent spray, simply press down on the trigger. For continuous spray, lift up on the trigger until it locks. To release, simply press the trigger back down. If you wish to remove the hook from the sprayer, unscrew the face. Slide the hook ring off the sprayer and remove the large, black, flat washer from inside the face. Replace the face.

**Parts**

- 1) Small Sprayer w/ Elbow
- 2) Mounting Tube
- 3) Escutcheon
- 4) Lock Nut
- 5) Washer
- 6) Hose
- 7) 1/2" Adaptor
- 8) Washer

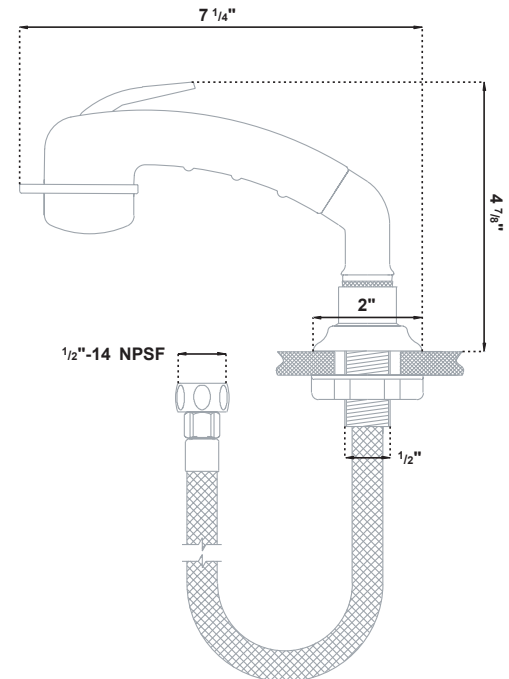
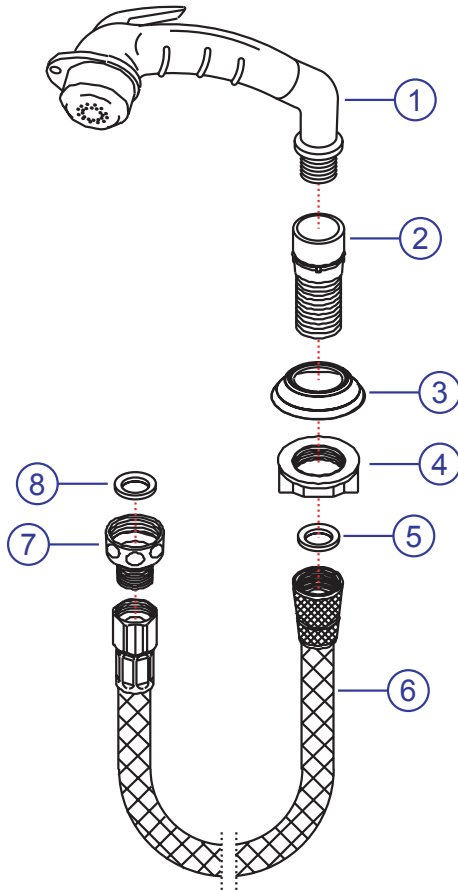

**PROPER FINISH CARE:**

Your new accessory is protected by a clear-coat. To clean it, you only need to wipe it with a damp, soft cloth. **NEVER** use any abrasive cleaners, steel wool, or chemicals, as they will harm the finish and void your warranty. If the accessory will be installed in a salt-air environment (boat exterior), regular cleaning with gentle soap and carnauba wax will prolong the life of the finish.

**LIMITED WARRANTY**

SHURflo Marine Grade Faucets & Accessories are guaranteed to be free from material and workmanship defects under normal use and service for a period of three (3) years from the date of manufactured vessel for all indoor applications and two (2) years from the date of manufactured vessel for all outdoor applications. This limited warranty will not apply to faucets or accessories that were improperly installed, misapplied, or incompatible with components not manufactured by SHURflo. Faucet failure due to foreign debris is not covered under the terms of this limited warranty. SHURflo will not warrant any faucet that is physically damaged, or altered outside the SHURflo factory. Warranty claims may be resolved by a SHURflo service center. All returns are to be shipped with charges pre-paid. Package all returns carefully. SHURflo will not be responsible for freight damage incurred during shipping to a service center. SHURflo's obligation under this warranty policy is limited to the repair or replacement of the faucets & accessories. Faucets or accessories found not defective (under the terms of this limited warranty) are subject to charges to be paid by the returnee for the testing and packaging of "tested good" units. Warranty returns will be shipped on a freight allowed basis. SHURflo reserves the right to choose the method of transportation. SHURflo is not responsible nor will it reimburse for labor necessary to remove and reinstall a faucet or accessory, if found defective. This warranty is only a representation of the complete Marine Products Limited Warranty outlined by Service Bulletin #1050.

*★ SHURflo reserves the right to update specifications, prices, or make substitutions.*



**SHURflo\***  
5900-A Katella Ave.  
Cypress, CA 90630  
(562) 795-5200 (800) 854-3218  
FAX (562) 795-7564  
**Shipping:** 5900-C Katella Ave.  
Cypress, CA 90630

**SHURflo East**  
52748 Park Six Court  
Elkhart, IN 46514-5427  
(574) 262-0478 (800) 762-8094  
FAX (574) 264-2169  
<http://www.shurflo.com>

**SHURflo Ltd.\***  
Unit 5 Sterling Park  
Gatwick Road, Crawley  
West Sussex, RH10 2QT  
United Kingdom  
+44 1293 424000  
FAX +44 1293 421880

