

SHURflo[®] Marine Grade Faucets

INSTALLATION INSTRUCTIONS

Your new SHURflo Marine Grade Faucet Accessory will give you years of trouble-free performance. Thank you for choosing SHURflo Marine Grade Faucets. Please read these instructions carefully before installing your new faucet accessory. If you have any additional questions about the installation of this faucet accessory, please feel free to contact one of our friendly customer service representatives at 1-800-854-3218.



135-0000-CP

Universal
Metal Shower Slide Bar
Chrome

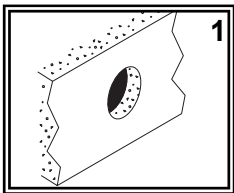

(1) Hold elbow on the wall where desired. Make sure to leave enough room for the hose to hang freely and extend into the shower. Drill 1" hole in the bulkhead in the desired location.

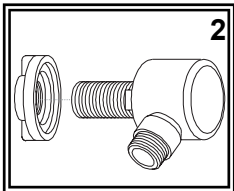

(2) Make sure male nipple is tight into the elbow with Teflon (Plumber's) tape. Slip nipple through the hole in the bulkhead. Make sure gasket properly lines up with the back of the elbow. From the back side of the bulkhead, thread the lock nut onto the brass nipple and tighten.

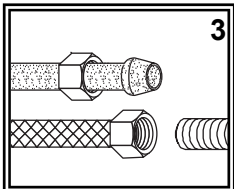

(3) Connect water supply lines (not provided) to the nipple. Wrap the end of the nipple with Teflon (Plumber's) tape. Follow the appropriate steps depending on your water supply lines. If you have a pre-assembled water supply hose with a threaded connector, simply screw on supply hose. If you have plastic water lines with formed ends, water line will seat partially up into the brass nipple. Connect by tightening the coupling nut. We do NOT suggest using sweat fittings as they are prone to blow-outs.

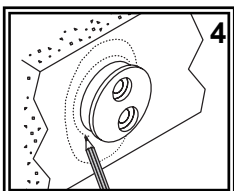

(4) Hold the bottom post on the wall where desired. With a pencil, lightly trace a circle completely around the base of the post. Remove the post. Hold a mounting bracket directly in the center of the outline. Trace a circle around the mounting bracket and the two mounting screw holes.

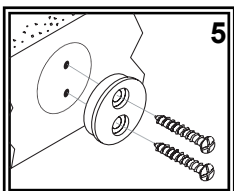

(5) Mount the bracket as shown. For mounting into fiberglass or other solid surface, drill a 1/8" starter hole and attach the bracket to the wall.

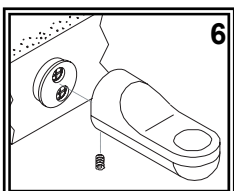

(6) Secure the post to the bracket with the set screw pointing away from the bar. Tighten the set screw.

(7) For the top post, merely set the bar into the bottom post and hold the top post at the correct spot. NOTE: Mount the top post "in" tightly so that there is no up and down movement of the bar. USE A BUBBLE LEVEL TO INSURE THAT THE BAR IS STRAIGHT. Trace a circle around the top post and mount (repeat steps 4-6).

(8) Attach your 1/2" hose to the connector. Turn the water supply on. While water is running, check all connections for leaks. Connections may need re-tightening.

(9) To adjust the height of the holder rotate the knob 1/4 turn to unlock, adjust to desired location and re-lock. You can also tilt the holder by rotating its head.

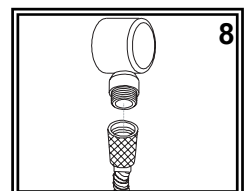
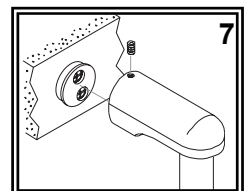

**CAUTION: THIS IS NOT A SAFETY DEVICE.
DO NOT USE AS A GRAB BAR.**

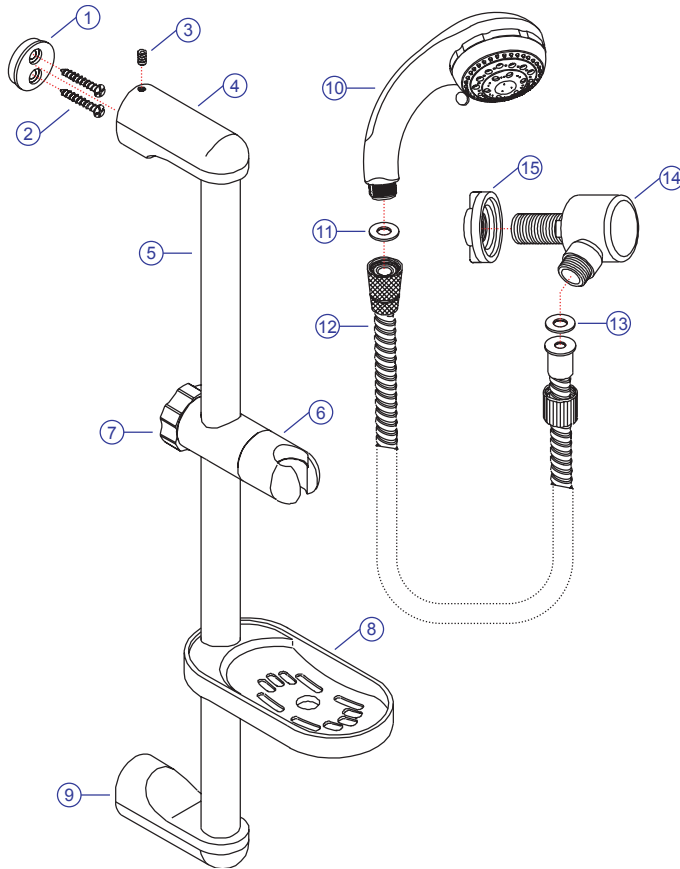

Parts

- 1) Mounting Bracket
- 2) Mounting Screws
- 3) Set Screw
- 4) Top Post
- 5) Bar
- 6) Holder
- 7) Knob
- 8) Soap Dish
- 9) Bottom Post
- 10) Sprayer Head
- 11) Washer
- 12) 72" Stainless Steel Hose
- 13) Washer
- 14) Elbow
- 15) Lock Nut

PROPER FINISH CARE:

Your new faucet is protected by a clear-coat. To clean it, you only need to wipe it with a damp, soft cloth. NEVER use any abrasive cleaners, steel wool, or chemicals, as they will harm the finish and void your warranty. If the faucet will be installed in a salt-air environment (boat exterior), regular cleaning with gentle soap and carnauba wax will prolong the life of the finish.

LIMITED WARRANTY

SHURflo Marine Grade Faucets & Accessories are guaranteed to be free from material and workmanship defects under normal use and service for a period of five (5) years from the date of purchase. This limited warranty will not apply to faucets or accessories that were improperly installed, misapplied, or incompatible with components not manufactured by SHURflo. Faucet failure due to foreign debris is not covered under the terms of this limited warranty. SHURflo will not warrant any faucet that is physically damaged or altered outside the SHURflo factory. Warranty claims may be resolved by a SHURflo service center. All returns are to be shipped with charges pre-paid. Package all returns carefully. SHURflo will not be responsible for freight damage incurred during shipping to a service center. SHURflo's obligation under this warranty policy is limited to the repair or replacement of the faucets & accessories. Faucets or accessories found not defective (under the terms of this limited warranty) are subject to charges to be paid by the returnee for the testing and packaging of "tested good" units. Warranty returns will be shipped on a freight allowed basis. SHURflo reserves the right to choose the method of transportation. SHURflo is not responsible nor will it reimburse for labor necessary to remove and reinstall a faucet or accessory if found defective. This warranty is only a representation of the complete Marine Products Limited Warranty outlined by Service Bulletin #1050.

**SHURflo reserves the right to update specifications, prices, or make substitutions.*



SHURflo*
 5900-A Katella Ave.
 Cypress, CA 90630
 (562) 795-5200 (800) 854-3218
 FAX (562) 795-7564
Shipping: 5900-C Katella Ave.
 Cypress, CA 90630

SHURflo East
 52748 Park Six Court
 Elkhart, IN 46514-5427
 (574) 262-0478 (800) 762-8094
 FAX (574) 264-2169
<http://www.shurflo.com>

SHURflo Ltd.*
 Unit 5 Sterling Park
 Gatwick Road, Crawley
 West Sussex, RH10 2QT
 United Kingdom
 +44 1293 424000
 FAX +44 1293 421880

