

## INSTALLATION INSTRUCTIONS

Thank you for choosing Ambassador Marine.

Your new Ambassador Marine faucet, shower, sprayer or accessory will give you years of trouble-free performance. Please read these instructions carefully before installing your new item. If you have any additional questions about the installation of this product, feel free to contact a customer service representative at 1.800.270.4262.



130-2209-\_\_

Erissa  
Soap Dish

Available Color/Finish Suffix Codes

-CP Chrome  
-NP Brushed Nickel

ANY SUFFIX FOLLOWED WITH "-R" OR "-W" INDICATES - RETAIL PACKAGED

## INSTALLING YOUR NEW AMBASSADOR MARINE UNIT:

### NEEDED / HELPFUL TOOLS

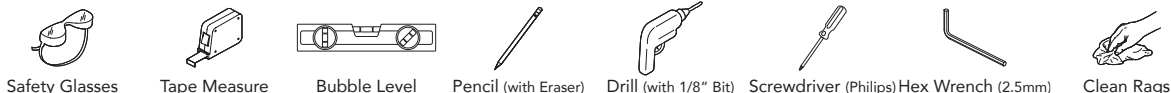

### TOWEL RING / ROBE HOOK / SINGLE POST T.P. HOLDER CUP HOLDER / SOAP DISH / SOAP BASKET

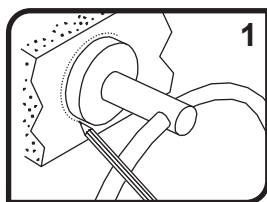

1) Hold the item on the wall where desired. With a pencil, lightly trace a circle/square completely around the base of the item (see figure 1). Remove the item. Hold the mounting bracket directly in the center of outline and trace the ovals/circles of the mounting bracket's screw holes (see figure 2).

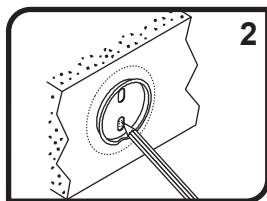

2) Secure the bracket to the wall. Note that the bracket has a dimpled edge, which is the bottom. For mounting into wood, fiberglass, or other solid surface, drill 1/8" starter holes and attach the bracket to the wall as shown (see figure 3). Carefully erase the pencil circle/square from tracing around the base.

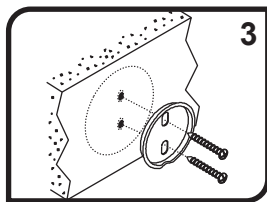

3) Secure the post to the bracket with the set screw pointing down (see figure 4). Tighten the set screw to secure the post to the bracket.

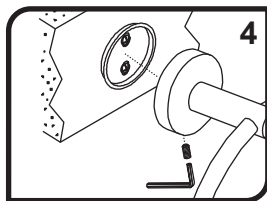

### 18" TOWEL BAR

1) Hold the complete towel bar assembly on the wall where desired. **USE A BUBBLE LEVEL TO INSURE THAT THE BAR IS LEVEL.** With a pencil, lightly trace a circle/square completely around the bases of both posts (see figure 1). Remove the towel bar. Hold a mounting bracket directly in the center of either of the bases' outline and trace the ovals/circles of the mounting bracket's screw holes (see figure 2). Repeat for the other mounting bracket.

2) Secure the brackets to the wall. Note that the brackets have a dimpled edge, which is the bottom. For mounting into wood, fiberglass, or other solid surface, drill 1/8" starter holes and attach the brackets to the wall as shown (see figure 3). Carefully erase the pencil circle/square from tracing around the bases.

3) Secure the posts to the brackets with the set screws pointing down (see figure 4). If both posts do not properly align with the brackets, one or both brackets may need to be slightly adjusted. Slightly loosen the mounting screws securing one of the brackets to the wall, allowing the mounting bracket to shift positioning within the mounting screws, correct the bracket's location on the wall and re-tighten the mounting screws. Tighten the set screws to secure the posts to the brackets.

## Parts

Design: Rev. A

- 1) Mounting Bracket
- 2) Mounting Screws
- 3) Assembly Screws
- 4) Base
- 5) Set Screw
- 6) Assembly Screw
- 7) Washer
- 8) Body
- 9) Cup/Dish Ring
- 10) Sleeve
- 11) Soap Dish (Plastic - Acrylic)

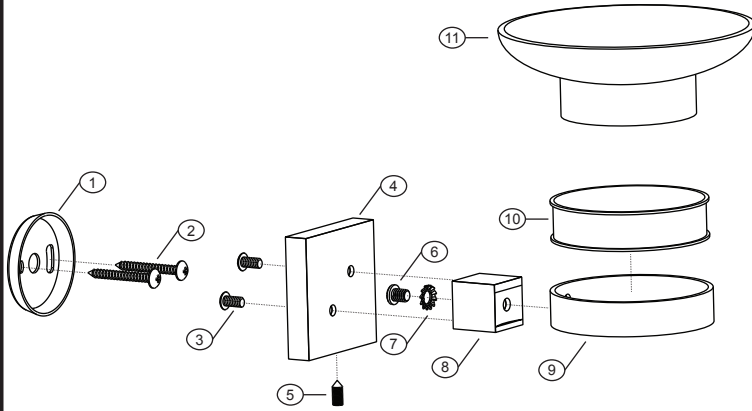

# 130-2209- \_ \_

SEE REVERSE FOR AVAILABLE  
COLOR/FINISH SUFFIX CODES

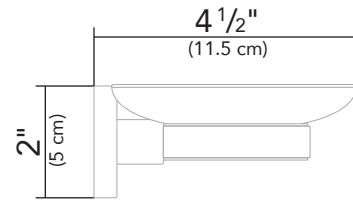
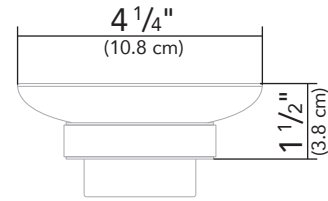

All dimensions  $\pm$   $\frac{1}{16}$ "  
Some components may not be drawn to scale

## PROPER FINISH CARE

Your new faucet or accessory is protected by a marine grade finish. To clean it, you only need to wipe it with a damp, soft cloth. NEVER use any abrasive cleaners, steel wool, or chemicals (including alcohol or ammonia), as they will harm the finish and void your warranty. If the item will be installed in a salt-air environment (boat exterior), regular cleaning with gentle soap and carnauba wax will prolong the life of the finish.

## LIMITED WARRANTY

Ambassador Marine faucets and accessories are guaranteed to be free from material and workmanship defects under normal use and service for a period of five (5) years from the date of purchase. This warranty will not apply to faucets or accessories that were improperly installed, misapplied, or incompatible with components not manufactured by Ambassador. Faucet failures due to foreign debris is not covered under the terms of this limited warranty. Ambassador will not warrant any faucet or accessory that is physically damaged, or altered outside the Ambassador factory.

Returns are to be shipped postage prepaid to Ambassador Marine's service center at: Ambassador Marine, 1173 Calle Suerte, Camarillo, CA 93012. A Return Authorization Number is required and must be clearly visible on the shipping carton.

Absolutely no credit or payment will be allowed for consumers on any item deemed defective. Ambassador Marine's obligation is limited to the repair or replacement of the defective item only, at Ambassador Marine's sole discretion. All returns will be examined and/or tested under Ambassador Marine test criteria. Replacements will be shipped freight prepaid.

This limited warranty is in lieu of all other warranties, expressed or implied, and no other person is authorized to give any other warranty or assume obligation or liability on Ambassador Marine's behalf. Ambassador Marine shall not be liable for any labor, damages, or other expenses, nor shall Ambassador Marine be liable for any indirect, incidental or consequential damages of any kind incurred by the use or sale of any defective product.

This limited warranty covers Marine Products sold or distributed in the United States and Canada only. Customers who purchase Ambassador Marine products sold by distributors in other countries must consult their local distributors for their warranty policy. **This warranty is only a representation of the complete Ambassador Marine warranty outlined on the Ambassador Marine website and/or catalog.**

**Ambassador**  
MARINE

Visit our web site at [www.ambassadormarine.com](http://www.ambassadormarine.com)

Ambassador Marine reserves the right to update specifications,  
change prices, or make substitutions without notice.

1173 Calle Suerte • Camarillo, CA 93012  
800.270.4262 • 805.482.0053 • Fax 805.482.0056  
[www.ambassadormarine.com](http://www.ambassadormarine.com) • [info@ambassadormarine.com](mailto:info@ambassadormarine.com)

Rev. 10/23  
© 2023 Ambassador Marine, Inc., All Rights Reserved