

INSTALLATION INSTRUCTIONS

Thank you for choosing Ambassador Marine.

Your new Ambassador Marine faucet, sprayer, shower or accessory will give you years of trouble-free performance. Please read these instructions carefully before installing your new item. If you have any additional questions about the installation of this product, please feel free to contact one of our friendly customer service representatives at 800.270.4262.

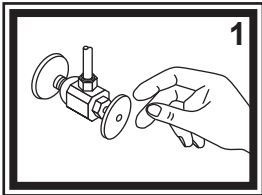

1) Turn off the water supply to your existing faucet (this procedure will vary depending on the specific plumbing system installed on your boat). Cover the sink drain to prevent any small parts or debris from falling in. Remove your existing faucet, taking care not to damage your existing water lines. Clean sink area in preparation for new faucet.

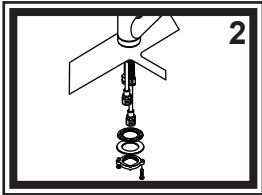

2) Place the faucet in the center hole (1 1/4" to 1 3/8" diameter hole - standard size) of the sink. Slide the black rubber washer and then the metal washer onto the mounting shaft. Screw the lock nut onto the mounting shaft with the two screws pointing up, as illustrated. Hand tighten the lock nut. Position the faucet on the sink ensuring that when the handle is in the off position (straight forward) it is centered between the hot and cold side-to-side rotation. The handle should swing about 45 degrees left and right from center. Tighten the lock nut screws with a screwdriver. **CAUTION: DO NOT OVER TIGHTEN THE SCREWS.**

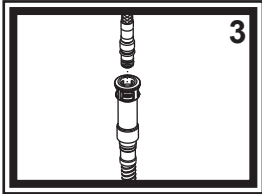

3) Ensure the quick connect housing is screwed all the way onto the pull-out hose. Push the quick connect housing firmly onto the return hose male fitting, until you feel it "snap" into place. Gently, but firmly pull down on the quick connect housing to ensure that it is properly secured. If the quick connect housing pulls off the return hose, repeat step 3. If it becomes necessary to disconnect the quick connect housing from the return hose after it is secured, simply lift up on the top collar/ring to disengage the quick release while pulling down on the housing.

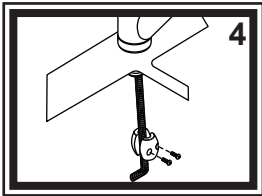

4) Attach weight to hose approximately 1 1/2" to 2" up from the bottom of the arch. Adjust position as desired. Weight should be installed to prevent hose kinking and for easy hose return.

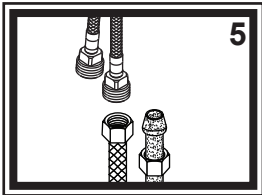

5) Connect hot and cold water supplies (not provided) to the 1/2" NPS-Male inlet hose fittings. Hot supply will connect to the red hose, cold supply will connect to the blue hose. Wrap the 1/2" NPS-Male brass fittings on the inlet hoses with Teflon (plumber's) tape. Follow the appropriate steps depending on your water supply lines. If you have pre-assembled water supply hoses with threaded connectors, simply screw on supply lines. If you have plastic water lines with formed ends, water lines will seat partially up into the brass fittings. Connect by tightening the coupling nuts. We do NOT suggest using sweat fittings as they are prone to blow-outs.

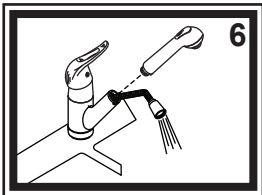

6) Pull the spout head a few inches out from the faucet and unscrew the spout head from the pull-out hose. Aim the hose down into the sink. Turn the water supply back on and allow both hot and cold water to run for at least one full minute without the spout head. While water is running, check all connections for leaks. Replace the spout head. Connections may need re-tightening.

Parts

- 1) Pacifica Handle
- 2) Blue/Red Cap
- 3) Handle Screw
- 4) Cap
- 5) Retainer Ring
- 6) Ceramic Disc Cartridge
- 7) Body Housing
- 8) O-Ring
- 9) Pin
- 10) Valve Body
- 11) O-Ring
- 12) Spout Hub
- 13) Hub Set Screw
- 14) Hose Nest
- 15) Spout Head
- 16) Packing Ring
- 17) Mounting Shaft
- 18) Base Ring
- 19) Gasket
- 20) Rubber Washer
- 21) Metal Washer
- 22) Lock Nut
- 23) Lock Nut Screws
- 24) Hose Guide
- 25) 4' Stainless Steel Hose
- 26) Inlet Hoses
- 27) Return Hose
- 28) Quick Connect Housing
- 29) Back Flow Preventer
- 30) Weight & Screws

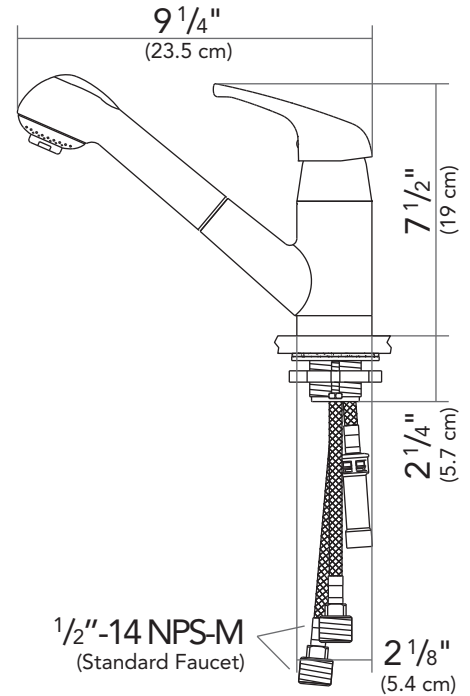
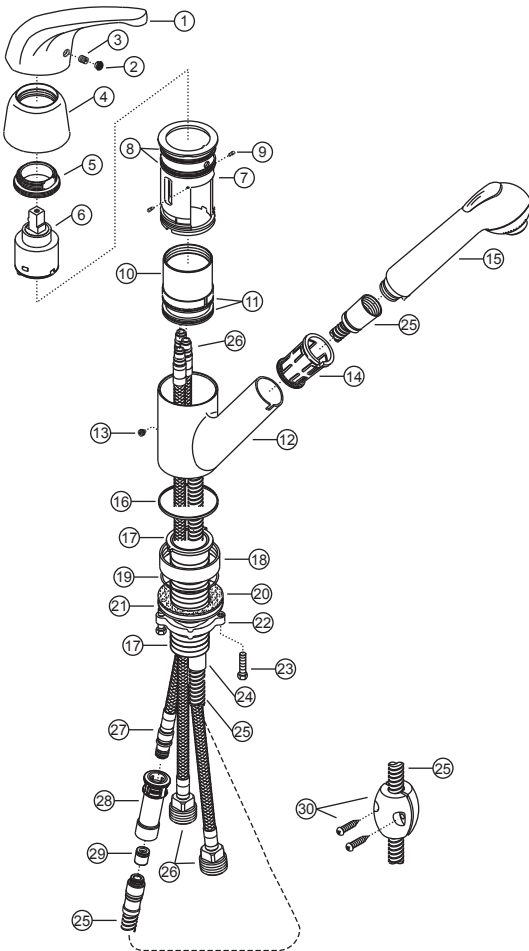

PROPER FINISH CARE

Your new faucet or accessory is protected by a clear-coat. To clean it, you only need to wipe it with a damp, soft cloth. NEVER use any abrasive cleaners, steel wool, or chemicals (including alcohol or ammonia), as they will harm the finish and void your warranty. If the item will be installed in a salt-air environment (boat exterior), regular cleaning with gentle soap and carnauba wax will prolong the life of the finish.

Visit our web site at www.ambassadormarine.com

Ambassador Marine reserves the right to update specifications, change prices, or make substitutions without notice.

LIMITED WARRANTY

Ambassador Marine faucets and accessories are guaranteed to be free from material and workmanship defects under normal use and service for a period of five (5) years from the date of purchase. This warranty will not apply to faucets or accessories that were improperly installed, misapplied, or incompatible with components not manufactured by Ambassador. Faucet failures due to foreign debris is not covered under the terms of this limited warranty. Ambassador will not warrant any faucet or accessory that is physically damaged, or altered outside the Ambassador factory.

Returns are to be shipped postage prepaid to Ambassador Marine's service center at: 1173 Calle Suerte, Camarillo, CA 93012.

A Return Authorization Number is required and must be clearly visible on the shipping carton.

Absolutely no credit or payment will be allowed for consumers on any item deemed defective. Ambassador Marine's obligation is limited to the repair or replacement of the defective item only, at Ambassador Marine's sole discretion. All returns will be examined and/or tested under Ambassador Marine test criteria. Replacements will be shipped freight prepaid.

This limited warranty is in lieu of all other warranties, expressed or implied, and no other person is authorized to give any other warranty or assume obligation or liability on Ambassador Marine's behalf. Ambassador Marine shall not be liable for any labor, damages, or other expenses, nor shall Ambassador Marine be liable for any indirect, incidental or consequential damages of any kind incurred by the use or sale of any defective product.

This limited warranty covers Marine Products sold or distributed in the United States and Canada only. Customers who purchase Ambassador Marine products sold by distributors in other countries must consult their local distributors for their warranty policy. This warranty is only a representation of the complete Ambassador Marine warranty outlined on the Ambassador Marine website and/or catalog.