

INSTALLATION INSTRUCTIONS

Thank you for choosing Ambassador Marine.

Your new Ambassador Marine faucet, shower, sprayer or accessory will give you years of trouble-free performance. Please read these instructions carefully before installing your new item. If you have any additional questions about the installation of this product, feel free to contact a customer service representative at 1.800.270.4262.



IF REPLACING AN EXISTING UNIT:

Turn off the water supply to your existing unit (this procedure will vary depending on the specific plumbing system installed on your boat). Cover the sink drain to prevent any small parts or debris from falling in. Remove your existing unit, taking care not to damage your existing water lines. Clean sink/counter-top area in preparation for new unit.

IF ADDING NEW HOLE(S) TO SINK/COUNTER-TOP:

See "Installation Hole Requirement" to the right, for this model. Check to ensure there is enough room for the unit, including necessary supply line(s), pull-out hose, etc. under the sink/counter-top. Drill hole, using proper bit for sink/counter-top surface and diameter.

Installation Hole Requirement

This unit requires a minimum of this/these hole(s)

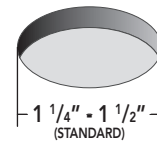

Your existing sink/counter-top may have additional hole(s) per-drilled, which may not be required for this installation. If so, you may be able to utilize a deck/cover plate or an additional accessory (i.e. soap dispenser) to utilize the extra hole(s). We offer a variety of deck/cover plates and soap dispensers to coordinate with your faucet and decor.

INSTALLING YOUR NEW AMBASSADOR MARINE UNIT:

NEEDED / HELPFUL TOOLS



Safety Glasses



Adjustable Wrench



Pliers



Screwdriver (Phillips)



Plumber's / Teflon Tape



Clean Rags

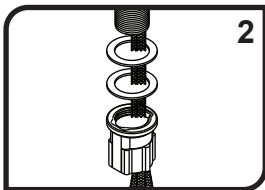

1) Remove the Mounting Nut (Easy Grip), metal and rubber Washers from the Mounting Shaft, if already attached. Pull the Spout Head and Stainless Steel Pull-Out Hose out until the male quick connect fitting on the hose reaches the bottom of the Mounting Shaft (having this 4th hose out of your way will make steps 2 and 3 easier!). Place the faucet through the hole in your sink/counter-top, making sure the O-Ring remains recessed in the Base. Position so that the O-Ring in the Base forms a seal all the way around the hole.

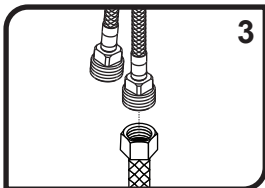

2) From under the sink, slide the rubber and metal Washers up the Mounting Shaft. Thread the Mounting Nut onto the Mounting Shaft and loosely tighten. Confirm the proper position of the faucet from above the sink. Position the faucet ensuring that when the handle is in the off position (straight forward) it is centered between the hot and cold side-to-side rotation. The handle and the spout should swing about 45 degrees left and right from center. Tighten the easy grip Mounting Nut by hand or with an adjustable wrench or pliers. It may be necessary to re-adjust the faucet position by slightly loosening the Mounting Nut, adjusting to the desired location, then re-tightening the Mounting Nut.

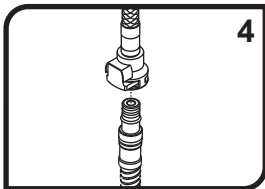

3) Connect water supply lines (not provided) to the Connector Hoses (red for hot, blue for cold). Supply line will vary depending on the specific plumbing system installed on your boat. To properly connect to the faucet, supply line must be the North American 'STANDARD 1/2" FAUCET' (1/2" NPS*) connector with a washer in the female connector. Wrap the end of the Inlet Tube with plumber's (Teflon) tape. Follow the appropriate steps depending on your water supply line. If you have a per-assembled water supply hose with threaded swivel-nut connector, simply screw on supply hose. We do NOT suggest using sweat fittings as they are prone to blow-outs.

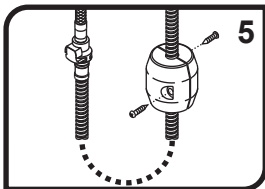

4) Push the Spout Head and Stainless Steel Pull-Out Hose all the way back into the Spout Hub. Firmly push the male quick connect fitting on the Pull-Out Hose into the female quick connect housing, until you feel it "snap" into place. Gently, but firmly pull down on the Pull-Out Hose to ensure that it is properly secured. If the quick connect fitting pulls out of the housing, repeat step while gently rotating the fitting side-to-side. If it becomes necessary to disconnect the quick connect Pull-Out Hose from the housing after it has been secured, simply press the release button on the side of the housing while pulling down on the Pull-Out Hose.

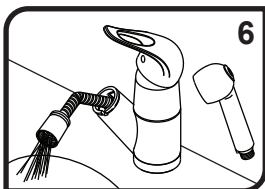

5) Attach weight to hose approximately 1 1/2" to 2" up from the bottom of the arch. Adjust position as desired. Weight should be installed to prevent hose kinking and for easy hose return.

6) After installation is complete, pull the Spout Head a few inches out from the faucet and unscrew the Spout Head from the Pull-Out Hose. Aim the hose down into the sink. Turn the water supply back on and allow both hot and cold water to run for at least one full minute without the spout head. While water is running, check all connections for leaks. Replace the Spout Head. Connections may need re-tightening.

Parts

Design: Rev. A

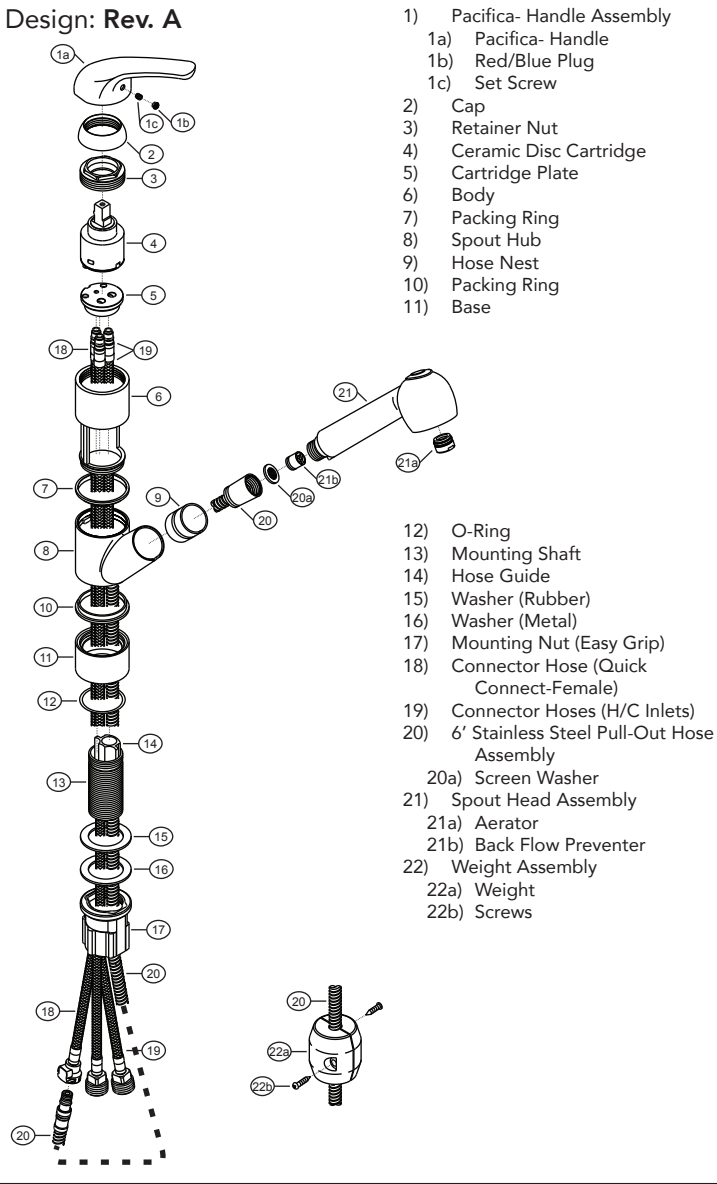

- 1) Pacifica- Handle Assembly
 - 1a) Pacifica- Handle
 - 1b) Red/Blue Plug
 - 1c) Set Screw
- 2) Cap
- 3) Retainer Nut
- 4) Ceramic Disc Cartridge
- 5) Cartridge Plate
- 6) Body
- 7) Packing Ring
- 8) Spout Hub
- 9) Hose Nest
- 10) Packing Ring
- 11) Base
- 12) O-Ring
- 13) Mounting Shaft
- 14) Hose Guide
- 15) Washer (Rubber)
- 16) Washer (Metal)
- 17) Mounting Nut (Easy Grip)
- 18) Connector Hose (Quick Connect-Female)
- 19) Connector Hoses (H/C Inlets)
- 20) 6' Stainless Steel Pull-Out Hose Assembly
 - 20a) Screen Washer
 - 20b) Spout Head Assembly
 - 20c) Aerator
 - 20d) Back Flow Preventer
- 21) Weight Assembly
 - 21a) Weight
 - 21b) Screws

132-0031- _ _

SEE REVERSE FOR AVAILABLE COLOR/FINISH SUFFIX CODES

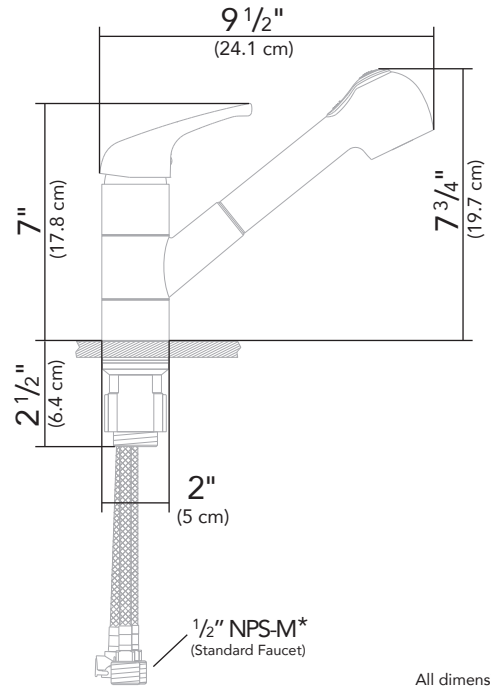

All dimensions \pm $\frac{1}{16}$ "
Some components may not be drawn to scale

* Supply Connection(s) - Understanding NPS vs. NPT

NPS = National Pipe Straight

NPT = National Pipe Tapered

(-M = Male -F = Female)

Straight Threads (Male)

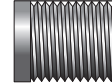

Tapered Threads (Male)

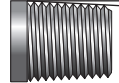

Plumbing fittings are commonly referred to as "NPT", however, in reality, nearly all FAUCETS are actually "NPS". NPS is the North American "STANDARD" for faucets, regardless of brand, style, application, etc. Outside North America, BSP is the most commonly used standard.

Both NPS and NPT have the same thread angle, shape, and pitch (threads per inch). However, NPS threads are straight (parallel) and NPT threads are tapered (reduced).

Straight Pipe thread is commonly found on faucets, showerheads, hose connections and fittings. Tapered Pipe thread is commonly found on pipe ends, nipples and fittings (i.e. couplings, elbows, tees, etc.). Straight Pipe threads need a gasket or o-ring to create a seal. Both styles require sealant or plumber's tape for optimal seal. While NPS and NPT threads will engage, they do not seal properly with each other.

PROPER FINISH CARE

Your new faucet or accessory is protected by a marine grade finish. To clean it, you only need to wipe it with a damp, soft cloth. NEVER use any abrasive cleaners, steel wool, or chemicals (including alcohol or ammonia), as they will harm the finish and void your warranty. If the item will be installed in a salt-air environment (boat exterior), regular cleaning with gentle soap and carnauba wax will prolong the life of the finish.

LIMITED WARRANTY

Ambassador Marine faucets and accessories are guaranteed to be free from material and workmanship defects under normal use and service for a period of five (5) years from the date of purchase. This warranty will not apply to faucets or accessories that were improperly installed, misapplied, or incompatible with components not manufactured by Ambassador. Faucet failures due to foreign debris is not covered under the terms of this limited warranty. Ambassador will not warrant any faucet or accessory that is physically damaged, or altered outside the Ambassador factory.

Returns are to be shipped postage prepaid to Ambassador Marine's service center at: Ambassador Marine, 1173 Calle Suerte, Camarillo, CA 93012. A Return Authorization Number is required and must be clearly visible on the shipping carton.

Absolutely no credit or payment will be allowed for consumers on any item deemed defective. Ambassador Marine's obligation is limited to the repair or replacement of the defective item only, at Ambassador Marine's sole discretion. All returns will be examined and/or tested under Ambassador Marine test criteria. Replacements will be shipped freight prepaid.

This limited warranty is in lieu of all other warranties, expressed or implied, and no other person is authorized to give any other warranty or assume obligation or liability on Ambassador Marine's behalf. Ambassador Marine shall not be liable for any labor, damages, or other expenses, nor shall Ambassador Marine be liable for any indirect, incidental or consequential damages of any kind incurred by the use or sale of any defective product.

This limited warranty covers Marine Products sold or distributed in the United States and Canada only. Customers who purchase Ambassador Marine products sold by distributors in other countries must consult their local distributors for their warranty policy. **This warranty is only a representation of the complete Ambassador Marine warranty outlined on the Ambassador Marine website and/or catalog.**

Ambassador
MARINE

1173 Calle Suerte • Camarillo, CA 93012
800.270.4262 • 805.482.0053 • Fax 805.482.0056
www.ambassadormarine.com • info@ambassadormarine.com

Visit our web site at www.ambassadormarine.com

Ambassador Marine reserves the right to update specifications, change prices, or make substitutions without notice.

Rev. 04/23
© 2023 Ambassador Marine, Inc., All Rights Reserved