



INSTALLATION INSTRUCTIONS

Thank you for choosing Ambassador Marine.

Your new Ambassador Marine faucet, shower, sprayer or accessory will give you years of trouble-free performance. Please read these instructions carefully before installing your new item. If you have any additional questions about the installation of this product, feel free to contact a customer service representative at 1.800.270.4262.



IF REPLACING AN EXISTING FAUCET:

Turn off the water supply to your existing faucet (this procedure will vary depending on the specific plumbing system installed on your boat). Cover the sink drain to prevent any small parts or debris from falling in. Remove your existing faucet, taking care not to damage your existing water lines. Clean sink/counter-top area in preparation for new faucet.

IF ADDING NEW HOLE(S) TO SINK/COUNTER-TOP:

See "Installation Hole Requirement" to the right, for this model. Check to ensure there is enough room for the faucet, including necessary supply line(s), pull-out hose, etc. under the sink/counter-top. Drill hole, using proper bit for sink/counter-top surface and diameter.

Installation Hole Requirement

This unit requires a minimum of this/these hole(s)

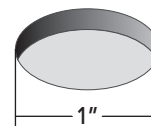

Your existing sink/counter-top may have additional hole(s) per-drilled, which may not be required for this installation. If so, you may be able to utilize a deck/cover plate or an additional accessory (i.e. soap dispenser) to utilize the extra hole(s). We offer a variety of deck/cover plates and soap dispensers to coordinate with your faucet and decor.

INSTALLING YOUR NEW AMBASSADOR MARINE UNIT:

NEEDED / HELPFUL TOOLS



Safety Glasses



Adjustable Wrench



Pliers



Plumber's (Teflon) Tape



Hex Wrench (2.5mm)



Clean Rags

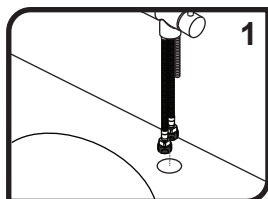

1) Remove the Mounting Nut, Metal Horseshoe Washer and Rubber Horseshoe Washer from the Mounting Rod, if already attached. Place the faucet through the hole in your sink/counter-top, making sure the Gasket remains recessed in the base of the Body and forms a seal all the way around the hole.

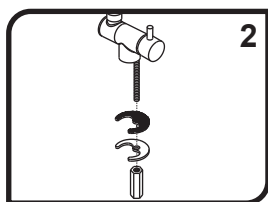

2) From under the sink, slide the Rubber Horseshoe and Metal Horseshoe Washers up the Mounting Rod with the washers wrapping around the Connector Hoses. Thread the Mounting Nut onto the Mounting Rod and hand-tighten. Confirm the proper position of the faucet from above the sink. Tighten the Mounting Nut with an adjustable wrench or pliers. It may be necessary to re-adjust the faucet position by slightly loosening the Mounting Nut, adjusting to the desired location, then re-tightening the Mounting Nut.

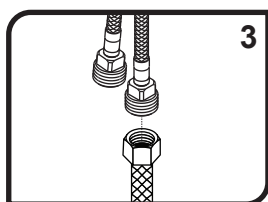

3) Connect water supply lines (not provided) to the Connector Hoses (red for hot, blue for cold). Supply line will vary depending on the specific plumbing system installed on your boat. To properly connect to the faucet, supply line must be the North American 'STANDARD 1/2" FAUCET' (1/2" NPS*) connector with a washer in the female connector. Wrap the end of the Inlet Tube with plumber's (Teflon) tape. Follow the appropriate steps depending on your water supply line. If you have a per-assembled water supply hose with threaded swivel-nut connector, simply screw on supply hose. We do NOT suggest using sweat fittings as they are prone to blow-outs.

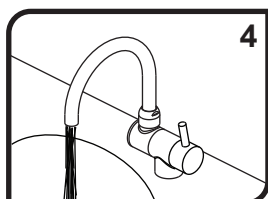

4) Turn the water supply on and allow both hot and cold water to run for at least one full minute. While water is running, check connections for leaks. Connections may need re-tightening. Turn handle on/off, rotate spout side-to-side and up-and-down a few times to verify proper function.

Parts

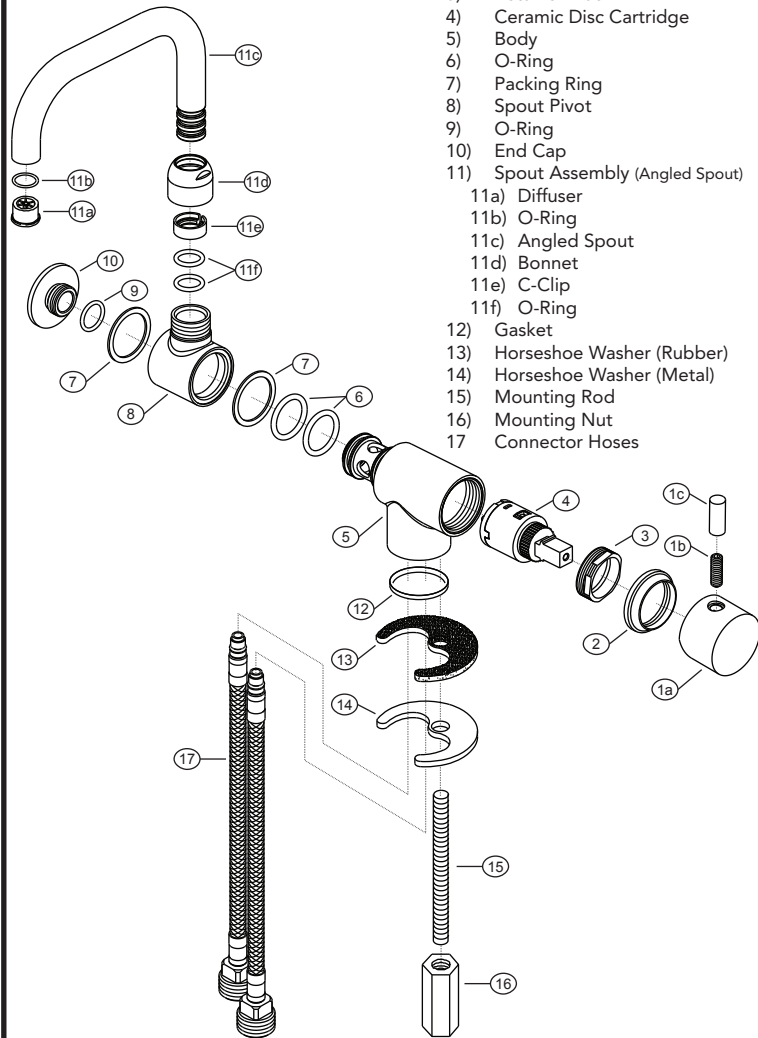

- 1) Aidack- Handle Assembly
- 1a) Aidack- Handle Canopy
- 1b) Set Screw
- 1c) Aidack- Handle Tip
- 2) Cap
- 3) Retainer Nut
- 4) Ceramic Disc Cartridge
- 5) Body
- 6) O-Ring
- 7) Packing Ring
- 8) Spout Pivot
- 9) O-Ring
- 10) End Cap
- 11) Spout Assembly (Angled Spout)
 - 11a) Diffuser
 - 11b) O-Ring
 - 11c) Angled Spout
 - 11d) Bonnet
 - 11e) C-Clip
 - 11f) O-Ring
- 12) Gasket
- 13) Horseshoe Washer (Rubber)
- 14) Horseshoe Washer (Metal)
- 15) Mounting Rod
- 16) Mounting Nut
- 17) Connector Hoses

132-1727-CP (OEM)

133-1727-CP (Retail)

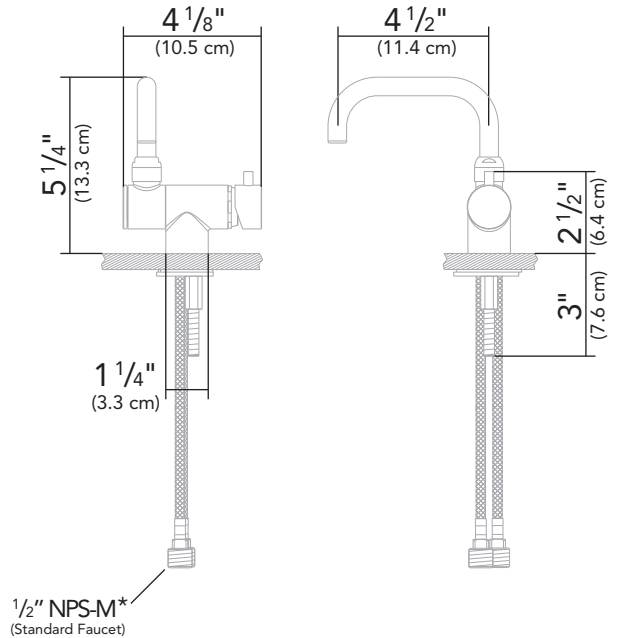

All dimensions $\pm 1/16$ "
Some components may not be drawn to scale

* Supply Connection(s) - Understanding NPS vs. NPT

NPS = National Pipe Straight

NPT = National Pipe Tapered

(-M = Male -F = Female)

Straight Threads (Male)

Tapered Threads (Male)

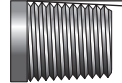
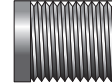

Plumbing fittings are commonly referred to as "NPT", however, in reality, nearly all FAUCETS are actually "NPS". NPS is the North American "STANDARD" for faucets, regardless of brand, style, application, etc. Outside North America, BSP is the most commonly used standard.

Both NPS and NPT have the same thread angle, shape, and pitch (threads per inch). However, NPS threads are straight (parallel) and NPT threads are tapered (reduced).

Straight Pipe thread is commonly found on faucets, showerheads, hose connections and fittings. Tapered Pipe thread is commonly found on pipe ends, nipples and fittings (i.e. couplings, elbows, tees, etc.). Straight Pipe threads need a gasket or o-ring to create a seal. Both styles require sealant or plumber's tape for optimal seal. While NPS and NPT threads will engage, they do not seal properly with each other.

PROPER FINISH CARE

Your new faucet or accessory is protected by a marine grade finish. To clean it, you only need to wipe it with a damp, soft cloth. NEVER use any abrasive cleaners, steel wool, or chemicals (including alcohol or ammonia), as they will harm the finish and void your warranty. If the item will be installed in a salt-air environment (boat exterior), regular cleaning with gentle soap and carnauba wax will prolong the life of the finish.

LIMITED WARRANTY

Ambassador Marine faucets and accessories are guaranteed to be free from material and workmanship defects under normal use and service for a period of five (5) years from the date of purchase. This warranty will not apply to faucets or accessories that were improperly installed, misapplied, or incompatible with components not manufactured by Ambassador. Faucet failures due to foreign debris is not covered under the terms of this limited warranty. Ambassador will not warrant any faucet or accessory that is physically damaged, or altered outside the Ambassador factory.

Returns are to be shipped postage prepaid to Ambassador Marine's service center at: Ambassador Marine, 1173 Calle Suerte, Camarillo, CA 93012. A Return Authorization Number is required and must be clearly visible on the shipping carton.

Absolutely no credit or payment will be allowed for consumers on any item deemed defective. Ambassador Marine's obligation is limited to the repair or replacement of the defective item only, at Ambassador Marine's sole discretion. All returns will be examined and/or tested under Ambassador Marine test criteria. Replacements will be shipped freight prepaid.

This limited warranty is in lieu of all other warranties, expressed or implied, and no other person is authorized to give any other warranty or assume obligation or liability on Ambassador Marine's behalf. Ambassador Marine shall not be liable for any labor, damages, or other expenses, nor shall Ambassador Marine be liable for any indirect, incidental or consequential damages of any kind incurred by the use or sale of any defective product.

This limited warranty covers Marine Products sold or distributed in the United States and Canada only. Customers who purchase Ambassador Marine products sold by distributors in other countries must consult their local distributors for their warranty policy. **This warranty is only a representation of the complete Ambassador Marine warranty outlined on the Ambassador Marine website and/or catalog.**

Ambassador
MARINE

1173 Calle Suerte • Camarillo, CA 93012
800.270.4262 • 805.482.0053 • Fax 805.482.0056
www.ambassadormarine.com • info@ambassadormarine.com

Visit our web site at www.ambassadormarine.com

Ambassador Marine reserves the right to update specifications, change prices, or make substitutions without notice.

Rev. 10/19
© 2019 Ambassador Marine, Inc., All Rights Reserved