

INSTALLATION INSTRUCTIONS

Thank you for choosing Ambassador Marine.

Your new Ambassador Marine faucet, sprayer, shower or accessory will give you years of trouble-free performance. Please read these instructions carefully before installing your new item. If you have any additional questions about the installation of this product, please feel free to contact one of our friendly customer service representatives at 800.270.4262.

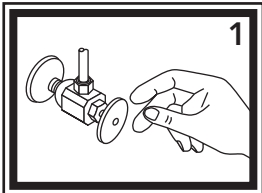

1) Turn off the water supply to your existing faucet (this procedure will vary depending on the specific plumbing system installed on your boat).

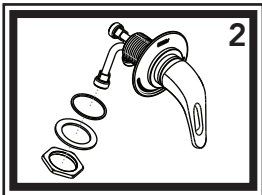

2) Unscrew the lock nut, metal washer and one gasket off the back of the valve body and slide off over the copper pipes. You may need to very gently bend the copper pipes closer together to allow the lock nut and metal washer to slide over the fittings.



3) Ensure that when the handle is in the off position (straight down) it lines up with the marking on the wall plate. If adjustment is needed, slightly loosen the escutcheon, adjust the wall plate and re-tighten.

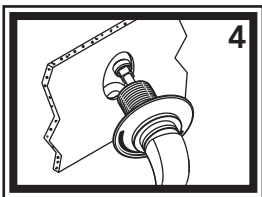

4) From the front side of the bulkhead, slide the valve assembly with the handle still attached through the hole in the bulkhead.

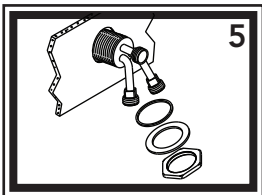

5) From the back side of the bulkhead, secure shower mixer by sliding the gasket, metal washer and lock nut back on over the copper pipes. Tightening against the back side of the bulkhead.

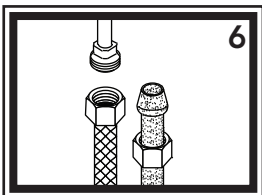

6) Connect hot/cold water supply lines (not provided) to the inlet tubes. The inlet tubes are the 1/2"-Male copper tubes on the left and right sides of the valve, which are curved downward to approx 90 degrees. This procedure will vary depending on the specific plumbing system installed on your boat. Using a swivel elbow fitting (not included), connect 1/2" water line from the shower head or bulkhead elbow (not included) to the shower head (straight) port. Wrap all fittings with Teflon (Plumber's) tape.

7) After installation is complete, turn the water supply back on and allow both hot and cold water to run for at least one full minute. While water is running, check all connections for leaks. Connections may need re-tightening.

Parts

- 1) Blue/Red Cap
- 2) Handle Screw
- 3) Stasis Handle
- 4) Cap
- 5) Retainer Nut
- 6) Ceramic Disc Cartridge
- 7) Escutcheon
- 8) O-Ring
- 9) Wall Plate
- 10) Gasket
- 11) Metal Washer
- 12) Lock Nut
- 13) Valve Body

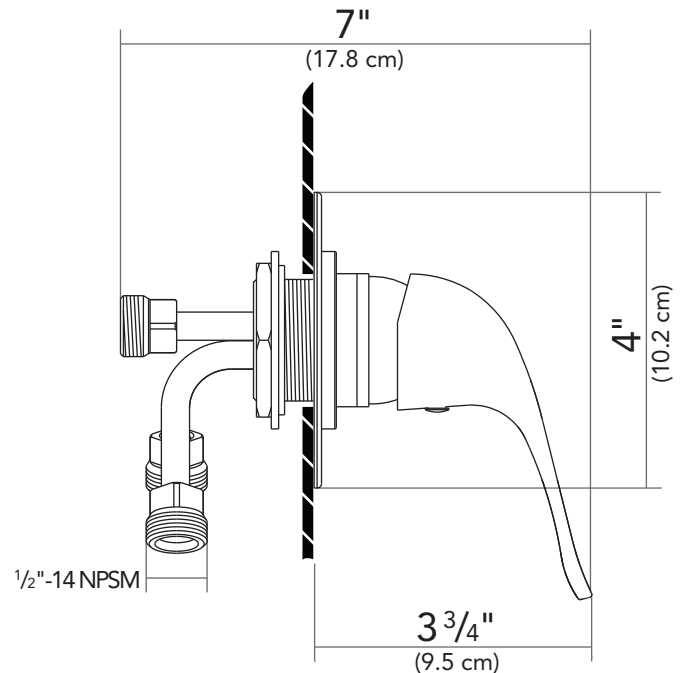
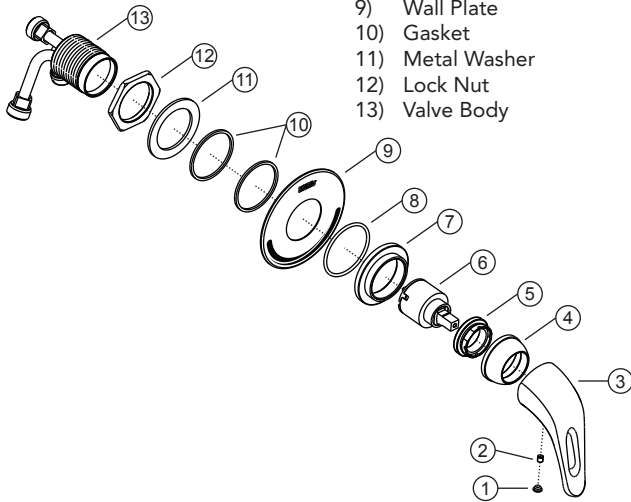

PROPER FINISH CARE

Your new faucet or accessory is protected by a clear-coat. To clean it, you only need to wipe it with a damp, soft cloth. NEVER use any abrasive cleaners, steel wool, or chemicals (including alcohol or ammonia), as they will harm the finish and void your warranty. If the item will be installed in a salt-air environment (boat exterior), regular cleaning with gentle soap and carnauba wax will prolong the life of the finish.

Visit our Web Site at <http://www.ambassadormarine.com>
 Ambassador Marine reserves the right to update specifications,
 change prices, or make substitutions without notice.

LIMITED WARRANTY

Ambassador Marine faucets and accessories are guaranteed to be free from material and workmanship defects under normal use and service for a period of five (5) years from the date of purchase. This warranty will not apply to faucets or accessories that were improperly installed, misapplied, or incompatible with components not manufactured by Ambassador. Faucet failures due to foreign debris is not covered under the terms of this limited warranty. Ambassador will not warrant any faucet or accessory that is physically damaged, or altered outside the Ambassador factory.

Returns are to be shipped postage prepaid to Ambassador Marine's service center at:
 1173 Calle Suerte, Camarillo, CA 93012.

A Return Authorization Number is required and must be clearly visible on the shipping carton.

Absolutely no credit or payment will be allowed for consumers on any item deemed defective. Ambassador Marine's obligation is limited to the repair or replacement of the defective item only, at Ambassador Marine's sole discretion. All returns will be examined and/or tested under Ambassador Marine test criteria. Replacements will be shipped freight prepaid.

This limited warranty is in lieu of all other warranties, expressed or implied, and no other person is authorized to give any other warranty or assume obligation or liability on Ambassador Marine's behalf. Ambassador Marine shall not be liable for any labor, damages, or other expenses, nor shall Ambassador Marine be liable for any indirect, incidental or consequential damages of any kind incurred by the use or sale of any defective product.

This limited warranty covers Marine Products sold or distributed in the United States and Canada only. Customers who purchase Ambassador Marine products sold by distributors in other countries must consult their local distributors for their warranty policy. This warranty is only a representation of the complete Ambassador Marine warranty outlined on the Ambassador Marine website and/or catalog.