

INSTALLATION INSTRUCTIONS

Thank you for choosing Ambassador Marine.

Your new Ambassador Marine faucet, sprayer, shower or accessory will give you years of trouble-free performance. Please read these instructions carefully before installing your new item. If you have any additional questions about the installation of this product, please feel free to contact one of our friendly customer service representatives at 800.270.4262.

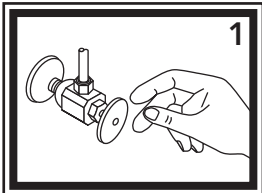
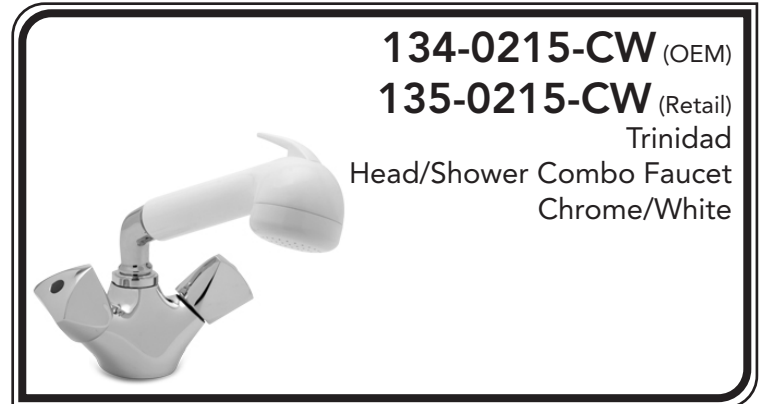

1) Turn off the water supply to your existing faucet (this procedure will vary depending on the specific plumbing system installed on your boat). Cover the sink drain to prevent any small parts or debris from falling in. Remove your existing faucet, taking care not to damage your existing water lines. Clean sink area in preparation for new faucet.

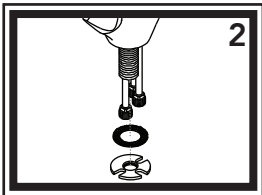

2) Remove the lock nut from the faucet by unscrewing the mounting tube. Remove rubber washer. Place your new faucet through the hole in your sink. Make sure the black gasket properly lines up with the bottom of the faucet. From under the sink, slide the rubber washer back onto the mounting tube. Align the lock nut between the three (3) connector hoses and the mounting tube. Secure faucet by rotating the mounting tube from above the sink. Be careful not to scratch the finish on the head of the mounting tube when using a wrench. It may be necessary to re-adjust the faucet position by slightly loosening the lock nut, adjusting to the desired location, then re-tightening the lock nut.

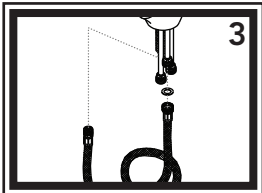

3) Connect sprayer hose to center connector hose. Wrap the brass fitting on the connector hose with Teflon (Plumber's) tape. From under the sink, insert the male end of the hose up through the mounting tube and out the top of the faucet.

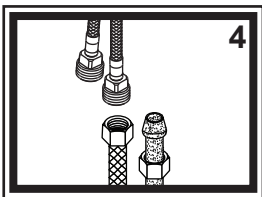

4) Connect water supply lines (not provided) to the connector hoses. Wrap the brass fittings on the inlet tubes with Teflon (Plumber's) tape. Follow the appropriate steps depending on your water supply lines. If you have pre-assembled water supply hoses with threaded connectors, simply screw on supply lines. If you have plastic water lines with formed ends, water lines will seat partially up into the brass fittings. Connect by tightening the coupling nuts. We do NOT suggest using sweat fittings as they are prone to blow-outs.

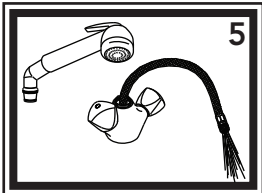

5) Before attaching the sprayer, pull the hose partially out and aim it down into the sink. Turn the water supply back on and allow both hot and cold water to run for at least one full minute without the sprayer. While water is running, check all connections for leaks. Attach sprayer to the hose. Connections may need re-tightening.

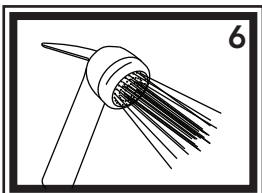

6) This sprayer has two functions: intermittent and continuous. For intermittent spray, simply press down on the trigger. For continuous spray, lift up on the trigger until it locks. To release, simply press the trigger back down.

Parts

- 1) Blue/Red Cap
- 2) Handle Screw
- 3) Trinidad Handle
- 4) Ceramic Disc Cartridge
- 5) Large White Sprayer
- 6) O-Ring
- 7) Washer
- 8) Mounting Tube
- 9) Body
- 10) Gasket
- 11) Washer
- 12) Lock Nut
- 13) Connector Hoses
- 14) Hose Washer
- 15) 6' White Rubber Hose

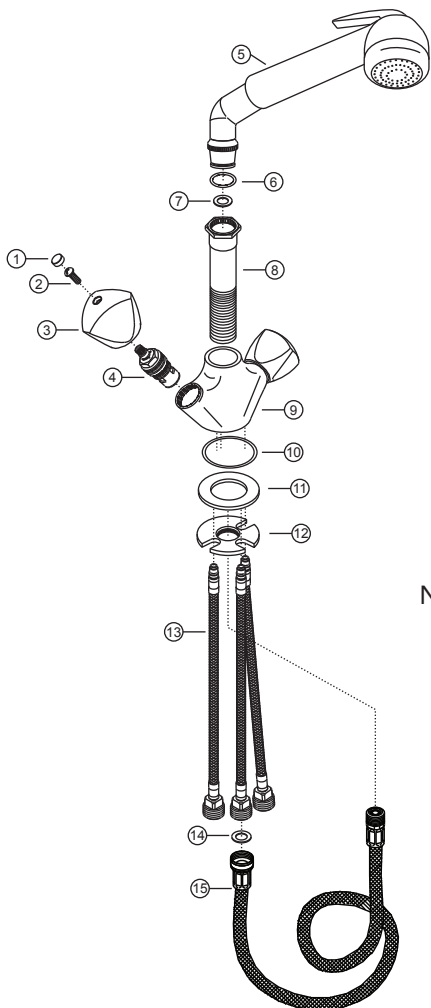

Need our matching (optional)
Bulkhead Sprayer Holder?
Ask for: 131-0212-CP

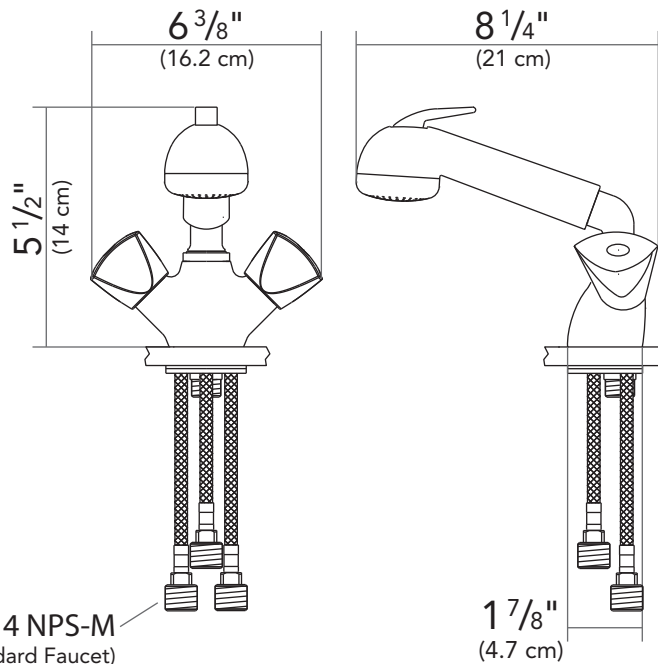

PROPER FINISH CARE

Your new faucet or accessory is protected by a clear-coat. To clean it, you only need to wipe it with a damp, soft cloth. NEVER use any abrasive cleaners, steel wool, or chemicals (including alcohol or ammonia), as they will harm the finish and void your warranty. If the item will be installed in a salt-air environment (boat exterior), regular cleaning with gentle soap and carnauba wax will prolong the life of the finish.

Visit our web site at www.ambassadormarine.com

Ambassador Marine reserves the right to update specifications, change prices, or make substitutions without notice.

LIMITED WARRANTY

Ambassador Marine faucets and accessories are guaranteed to be free from material and workmanship defects under normal use and service for a period of five (5) years from the date of purchase. This warranty will not apply to faucets or accessories that were improperly installed, misapplied, or incompatible with components not manufactured by Ambassador. Faucet failures due to foreign debris is not covered under the terms of this limited warranty. Ambassador will not warrant any faucet or accessory that is physically damaged, or altered outside the Ambassador factory.

Returns are to be shipped postage prepaid to Ambassador Marine's service center at:
1173 Calle Suerte, Camarillo, CA 93012.

A Return Authorization Number is required and must be clearly visible on the shipping carton.

Absolutely no credit or payment will be allowed for consumers on any item deemed defective. Ambassador Marine's obligation is limited to the repair or replacement of the defective item only, at Ambassador Marine's sole discretion. All returns will be examined and/or tested under Ambassador Marine test criteria. Replacements will be shipped freight prepaid.

This limited warranty is in lieu of all other warranties, expressed or implied, and no other person is authorized to give any other warranty or assume obligation or liability on Ambassador Marine's behalf. Ambassador Marine shall not be liable for any labor, damages, or other expenses, nor shall Ambassador Marine be liable for any indirect, incidental or consequential damages of any kind incurred by the use or sale of any defective product.

This limited warranty covers Marine Products sold or distributed in the United States and Canada only. Customers who purchase Ambassador Marine products sold by distributors in other countries must consult their local distributors for their warranty policy. This warranty is only a representation of the complete Ambassador Marine warranty outlined on the Ambassador Marine website and/or catalog.