



## INSTALLATION INSTRUCTIONS

Thank you for choosing Ambassador Marine.

Your new Ambassador Marine faucet, shower, sprayer or accessory will give you years of trouble-free performance. Please read these instructions carefully before installing your new item. If you have any additional questions about the installation of this product, feel free to contact a customer service representative at 1.800.270.4262.

**134-0041-\_\_**  
**Universal  
Deck-Mount Sprayer**

Available Color/Finish Suffix Codes  
-KP Black  
-WH Warm White



ANY SUFFIX FOLLOWED WITH "-R" OR  
"-W" INDICATES - RETAIL PACKAGED

### IF REPLACING AN EXISTING UNIT:

Turn off the water supply to your existing unit (this procedure will vary depending on the specific plumbing system installed on your boat). Cover the sink drain to prevent any small parts or debris from falling in. Remove your existing unit, taking care not to damage your existing water lines. Clean sink/counter-top area in preparation for new unit.

### IF ADDING NEW HOLE(S) TO SINK/COUNTER-TOP:

See "Installation Hole Requirement" to the right, for this model. Check to ensure there is enough room for the unit, including necessary supply line(s), pull-out hose, etc. under the sink/counter-top. Drill hole, using proper bit for sink/counter-top surface and diameter.

### Installation Hole Requirement

This unit requires a minimum of this/these hole(s)

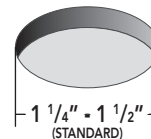

Your existing sink/counter-top may have additional hole(s) pre-drilled, which may not be required for this installation. If so, you may be able to utilize a deck/cover plate or an additional accessory (i.e. soap dispenser) to utilize the extra hole(s). We offer a variety of deck/cover plates and soap dispensers to coordinate with your faucet and decor.

## INSTALLING YOUR NEW AMBASSADOR MARINE UNIT:

### NEEDED / HELPFUL TOOLS



Safety Glasses



Drill (with 1" Bit)



Adjustable Wrench



Pliers



Plumber's (Teflon) Tape



Clean Rags

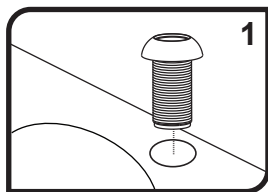

1

1) Check desired position to make sure there is enough room for the hose to gather under the deck without getting caught on anything. Remove the Lock Nut (with screws) and the Metal Washer from the Sprayer Holder Assembly's Shaft, if already attached. Place the Sprayer Holder Assembly through the hole in your sink/counter-top, making sure the Gasket remains recessed in the Sprayer Holder Head and forms a seal all the way around the hole.

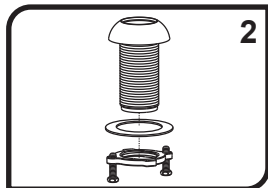

2

2) From under the sink, slide the Metal Washer up the Shaft and thread the Lock Nut onto the Shaft with the two Screws pointing up, as illustrated. Hand tighten the Lock Nut. Confirm the proper position of the Sprayer Holder Assembly from above the sink. It may be necessary to re-adjust the holder position by slightly loosening the Lock Nut, adjusting to desired location, then re-tightening the lock nut. Once positioned, tighten the Lock Nut Screws with a screwdriver. CAUTION: DO NOT OVER TIGHTEN THE SCREWS.

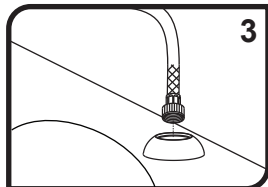

3

3) Feed the non-conical end of the Hose down through the Sprayer Holder Assembly from above the sink.

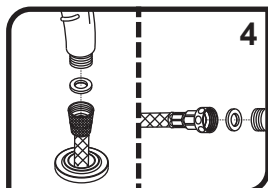

4

4) Screw conical end of the hose onto sprayer using one of the 1/2" rubber washer included. Connect non-conical end of the hose to desired water source or valve using the the remaining 1/2" rubber washer. Water source will vary depending on the specific plumbing system and configuration installed on your boat. To properly connect to the hose, source must be the North American 'STANDARD 1/2" FAUCET' (1/2" NPS\*) male connector. Wrap male fitting with plumber's (Teflon) tape. Follow the appropriate steps depending on your water source. We do NOT suggest using sweat fittings as they are prone to blow-outs. Turn water supply on and allow water to run for at least one full minute. While water is running, check connections for leaks. Connections may need re-tightening.

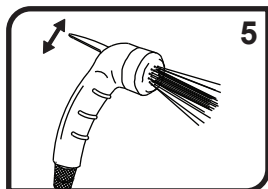

5

5) This sprayer has two functions: intermittent and continuous. For intermittent spray, simply press down on the trigger. For continuous spray, lift up on the trigger until it locks. To release, simply press the trigger back down.

## Parts

Design: Rev. B

- 1) Hammer-Head Sprayer (with elbow) (for Elite Base) Assembly
- 2) Elite Sprayer Holder Assembly
  - 2a) Elite Sprayer Holder Head
  - 2b) Gasket
  - 2c) Mounting Shaft
  - 2d) Metal Washer
  - 2e) Lock Nut
  - 2f) Lock Nut Screws
- 3) 6' Extra-Soft Rubber Hose Assembly
  - 3a) Washer

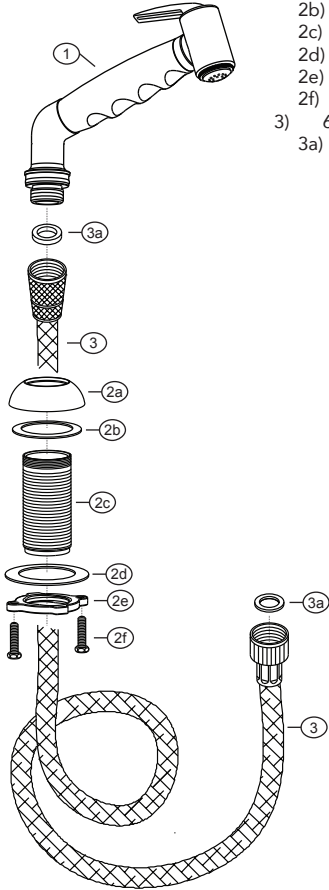

Need the matching  
**Bulkhead  
Sprayer Holder**  
to fit with this  
sprayer? Ask for:  
**131-0042-CP**  
fits standard 1/2" hose conicals



# 134-0041- \_ \_

SEE REVERSE FOR AVAILABLE  
COLOR/FINISH SUFFIX CODES

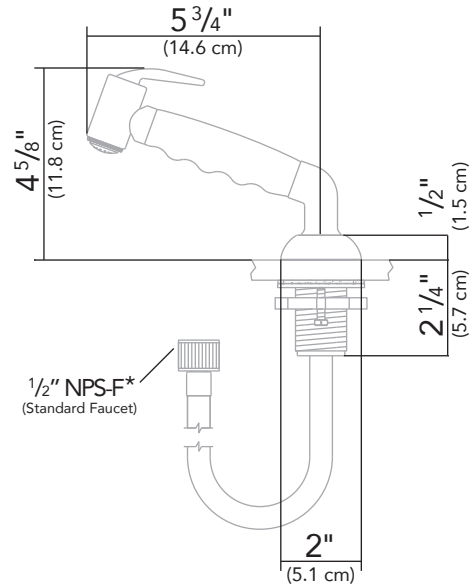

All dimensions  $\pm 1/16$ "  
Some components may not be drawn to scale

### \* Supply Connection(s) - Understanding NPS vs. NPT

**NPS** = National Pipe Straight

**NPT** = National Pipe Tapered

(-M = Male -F = Female)

Straight Threads (Male)

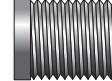

Tapered Threads (Male)

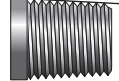

Plumbing fittings are commonly referred to as "NPT", however, in reality, nearly all FAUCETS are actually "NPS". NPS is the North American "STANDARD" for faucets, regardless of brand, style, application, etc. Outside North America, BSP is the most commonly used standard.

Both NPS and NPT have the same thread angle, shape, and pitch (threads per inch). However, NPS threads are straight (parallel) and NPT threads are tapered (reduced).

Straight Pipe thread is commonly found on faucets, showerheads, hose connections and fittings. Tapered Pipe thread is commonly found on pipe ends, nipples and fittings (i.e. couplings, elbows, tees, etc.). Straight Pipe threads need a gasket or o-ring to create a seal. Both styles require sealant or plumber's tape for optimal seal. While NPS and NPT threads will engage, they do not seal properly with each other.

## PROPER FINISH CARE

Your new faucet or accessory is protected by a marine grade finish. To clean it, you only need to wipe it with a damp, soft cloth. NEVER use any abrasive cleaners, steel wool, or chemicals (including alcohol or ammonia), as they will harm the finish and void your warranty. If the item will be installed in a salt-air environment (boat exterior), regular cleaning with gentle soap and carnauba wax will prolong the life of the finish.

## LIMITED WARRANTY

Ambassador Marine faucets and accessories are guaranteed to be free from material and workmanship defects under normal use and service for a period of five (5) years from the date of purchase. This warranty will not apply to faucets or accessories that were improperly installed, misapplied, or incompatible with components not manufactured by Ambassador. Faucet failures due to foreign debris is not covered under the terms of this limited warranty. Ambassador will not warrant any faucet or accessory that is physically damaged, or altered outside the Ambassador factory.

Returns are to be shipped postage prepaid to Ambassador Marine's service center at: Ambassador Marine, 1173 Calle Suerte, Camarillo, CA 93012. A Return Authorization Number is required and must be clearly visible on the shipping carton.

Absolutely no credit or payment will be allowed for consumers on any item deemed defective. Ambassador Marine's obligation is limited to the repair or replacement of the defective item only, at Ambassador Marine's sole discretion. All returns will be examined and/or tested under Ambassador Marine test criteria. Replacements will be shipped freight prepaid.

This limited warranty is in lieu of all other warranties, expressed or implied, and no other person is authorized to give any other warranty or assume obligation or liability on Ambassador Marine's behalf. Ambassador Marine shall not be liable for any labor, damages, or other expenses, nor shall Ambassador Marine be liable for any indirect, incidental or consequential damages of any kind incurred by the use or sale of any defective product.

This limited warranty covers Marine Products sold or distributed in the United States and Canada only. Customers who purchase Ambassador Marine products sold by distributors in other countries must consult their local distributors for their warranty policy. **This warranty is only a representation of the complete Ambassador Marine warranty outlined on the Ambassador Marine website and/or catalog.**

**Ambassador**  
MARINE

1173 Calle Suerte • Camarillo, CA 93012  
800.270.4262 • 805.482.0053 • Fax 805.482.0056  
www.ambassadormarine.com • info@ambassadormarine.com

Visit our web site at [www.ambassadormarine.com](http://www.ambassadormarine.com)

Ambassador Marine reserves the right to update specifications,  
change prices, or make substitutions without notice.

Rev. 05/26  
© 2026 Ambassador Marine, Inc., All Rights Reserved