



INSTALLATION INSTRUCTIONS

Thank you for choosing Ambassador Marine.

Your new Ambassador Marine faucet, shower, sprayer or accessory will give you years of trouble-free performance. Please read these instructions carefully before installing your new item. If you have any additional questions about the installation of this product, feel free to contact a customer service representative at 1.800.270.4262.



S00-0104-__
2" Drain
Straight Drain Kit
1 1/4" Threads

Available Color/Finish Suffix Codes
-BP Brushed
-UP Ultra-Mirror

ANY SUFFIX FOLLOWED WITH "-R" OR "-W" INDICATES - RETAIL PACKAGED

DRAIN SIZE:

The Drain Size is a standardized term used to refer to the category of drain body or flange sizes. The actual hole in the sink is typically 1/16" to 1/2" larger diameter than the "Drain Size".

IF REPLACING AN EXISTING UNIT:

Remove your existing unit, taking care not to damage your existing sink or drain line. Remove any existing plumber's putty and clean inside and bottom of sink surface in preparation for new unit.

Installation Hole Requirement

This unit requires the drain hole to be this size or slightly larger:

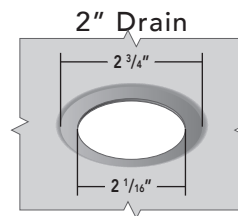

INSTALLING YOUR NEW AMBASSADOR MARINE UNIT:

NEEDED / HELPFUL TOOLS

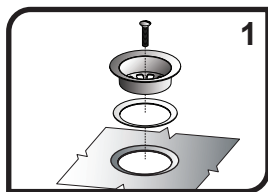

1) Set the Flange with the Foam Gasket and Screw in the drain hole in the sink. **NOTE:** The Foam Gasket is supplied for your convenience, however, we recommend using plumber's putty (not included) instead of the Foam Gasket. Do not use both the Foam Gasket and plumber's putty.

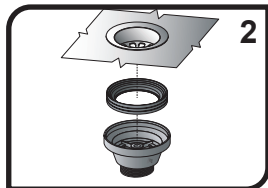

2) From under the sink, line up the Body with the Rubber Gasket with the Flange and Screw.

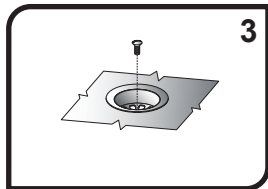

3) From above the sink, tighten the Screw into the metal nut inside the Body.

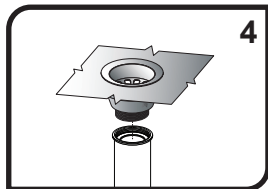

4) Screw 1 1/4" drain pipe or adapter (not included) onto the Body. Use Teflon tape (not included) on the threads to prevent leaks.

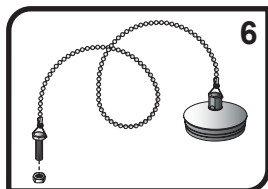

5) Remove the protective sticker from the polished surface of the Stopper.

6) **OPTIONAL-** Drill a 3/16" hole in the counter-top or other surface and secure the Stopper Screw using the Stopper Nut, where desired. If you choose not to secure the Stopper Screw, you may remove the Stopper Chain from the Stopper. Spread the ends of the Stopper Triangle Connector and remove it from the Stopper.

Need the matching
3/4" & 1"
Straight Hose Barb
Ask for:
S00-0020-PL
followed with "-R" or "-W"
for RETAIL PACKAGED



Need the matching
1 1/4" & 1 1/2"
Straight Hose Barb
Ask for:
S00-0021-PL
followed with "-R" or "-W"
for RETAIL PACKAGED



Need the matching
3/4" & 1"
90° Hose Barb
Ask for:
S00-0022-PL
followed with "-R" or "-W"
for RETAIL PACKAGED



Parts

Design: Rev. A

- 1) 2" Chain Stopper Assembly
 - 1a) Stopper Nut
 - 1b) Stopper Screw
 - 1c) Stopper Chain
 - 1d) Triangle Connector
 - 1e) Stopper
- 2) Screw
- 3) Flange
- 4) Foam Gasket
- 5) Rubber Gasket
- 6) Body
- 7) Nut

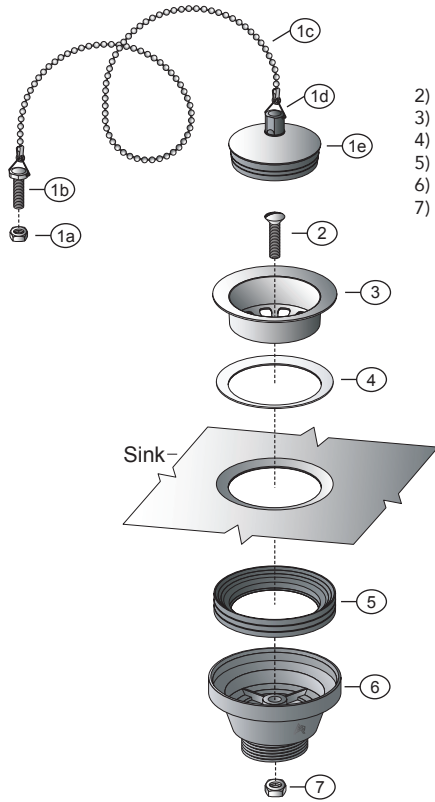

S00-0104- _ _

SEE REVERSE FOR AVAILABLE
COLOR/FINISH SUFFIX CODES

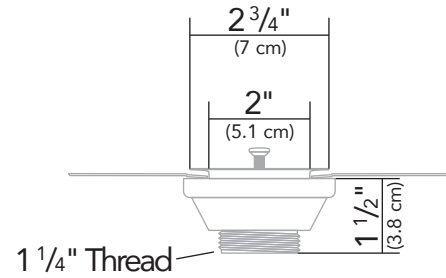

All dimensions $\pm 1/16$ "

Some components may not be drawn to scale

PROPER FINISH CARE

Your new faucet or accessory is protected by a marine grade finish. To clean it, you only need to wipe it with a damp, soft cloth. NEVER use any abrasive cleaners, steel wool, or chemicals (including alcohol or ammonia), as they will harm the finish and void your warranty. If the item will be installed in a salt-air environment (boat exterior), regular cleaning with gentle soap and carnauba wax will prolong the life of the finish.

LIMITED WARRANTY

Ambassador Marine faucets and accessories are guaranteed to be free from material and workmanship defects under normal use and service for a period of five (5) years from the date of purchase. This warranty will not apply to faucets or accessories that were improperly installed, misapplied, or incompatible with components not manufactured by Ambassador. Faucet failures due to foreign debris is not covered under the terms of this limited warranty. Ambassador will not warrant any faucet or accessory that is physically damaged, or altered outside the Ambassador factory.

Returns are to be shipped postage prepaid to Ambassador Marine's service center at: Ambassador Marine, 1173 Calle Suerte, Camarillo, CA 93012. A Return Authorization Number is required and must be clearly visible on the shipping carton.

Absolutely no credit or payment will be allowed for consumers on any item deemed defective. Ambassador Marine's obligation is limited to the repair or replacement of the defective item only, at Ambassador Marine's sole discretion. All returns will be examined and/or tested under Ambassador Marine test criteria. Replacements will be shipped freight prepaid.

This limited warranty is in lieu of all other warranties, expressed or implied, and no other person is authorized to give any other warranty or assume obligation or liability on Ambassador Marine's behalf. Ambassador Marine shall not be liable for any labor, damages, or other expenses, nor shall Ambassador Marine be liable for any indirect, incidental or consequential damages of any kind incurred by the use or sale of any defective product.

This limited warranty covers Marine Products sold or distributed in the United States and Canada only. Customers who purchase Ambassador Marine products sold by distributors in other countries must consult their local distributors for their warranty policy. **This warranty is only a representation of the complete Ambassador Marine warranty outlined on the Ambassador Marine website and/or catalog.**

Ambassador
MARINE

Visit our web site at www.ambassadormarine.com

Ambassador Marine reserves the right to update specifications,
change prices, or make substitutions without notice.

1173 Calle Suerte • Camarillo, CA 93012

800.270.4262 • 805.482.0053 • Fax 805.482.0056

www.ambassadormarine.com • info@ambassadormarine.com

Rev. 04/23

© 2023 Ambassador Marine, Inc., All Rights Reserved