

SHURflo[®] Marine Grade Faucets

INSTALLATION INSTRUCTIONS

OEM Version

Attention Manufacturers:
Please include this Installation
Instruction sheet with your Owner's
Documentation.

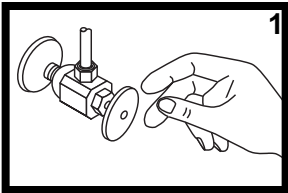

- (1) Turn off the water supply to your existing faucet (this procedure will vary depending on the specific plumbing system installed on your boat). Cover the sink drain to prevent any small parts or debris from falling in. Remove your existing faucet, taking care not to damage your existing water lines. Clean sink area in preparation for new faucet.

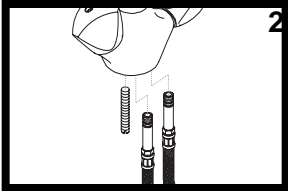

- (2) Screw mounting bolt into the bottom of the faucet. One end of the bolt is slotted to allow the use of a screwdriver to secure. Screw both connector hoses into the bottom of faucet (note: it is NOT necessary to use Teflon (Plumber's) tape on this connection as the o-rings will prevent leaks). Use a wrench or pliers on the hex nut molded into the brass shaft portion of the hoses. Do NOT attempt to tighten by turning the hose itself.

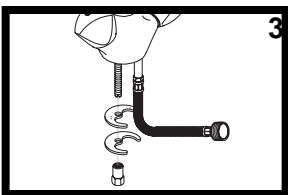

- (3) Place your new faucet through the hole in your sink. Make sure the black gasket properly lines up with the bottom of the faucet. From under the sink, slide the rubber horseshoe washer then the metal horseshoe washer onto the mounting bolt. Adjust faucet position on the sink as desired. Thread the lock nut onto the mounting bolt and tighten. It may be necessary to re-adjust the faucet position by slightly loosening the lock nut, adjusting to desired location, then re-tightening the lock nut.

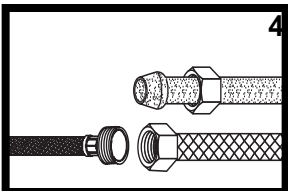

- (4) Connect water supply lines (not provided) to the connector hoses. Wrap the brass fittings on the connector hoses with Teflon (Plumber's) tape. Follow the appropriate steps depending on your water supply lines. If you have pre-assembled water supply hoses with threaded connectors, simply screw on supply hose. If you have plastic water lines with formed ends, water lines will seat partially up into the brass fittings. Connect by tightening the coupling nuts. We do NOT suggest using sweat fittings as they are prone to blow-outs.

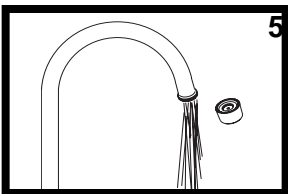

- (5) After installation is complete, remove the aerator. Be careful not to scratch the finish. Turn the water supply back on and allow both hot and cold water to run for at least one full minute. While water is running, check all connections for leaks. Replace aerator. Connections may need re-tightening.

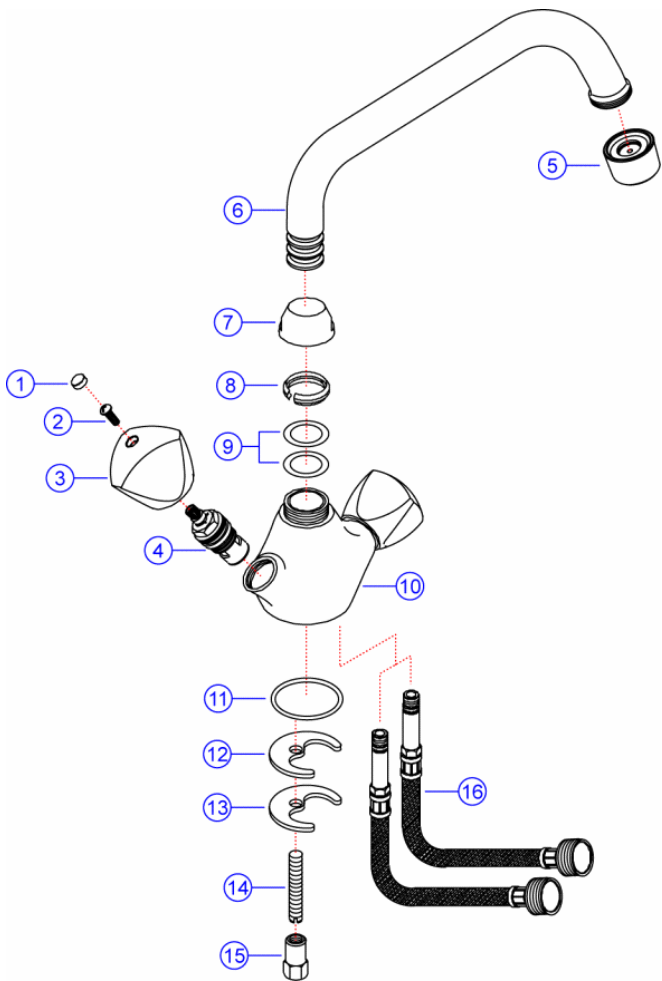

Parts

- 1) Blue/Red Cap
- 2) Handle Screw
- 3) Trinidad Handle
- 4) Ceramic Disc Cartridge
- 5) Aerator
- 6) Spout
- 7) Spout Bonnet
- 8) Spout C-Clamp
- 9) Spout O-Rings
- 10) Body
- 11) Gasket
- 12) Rubber Horseshoe Washer
- 13) Metal Horseshoe Washer
- 14) Mounting Bolt
- 15) Lock Nut
- 16) Connector Hoses

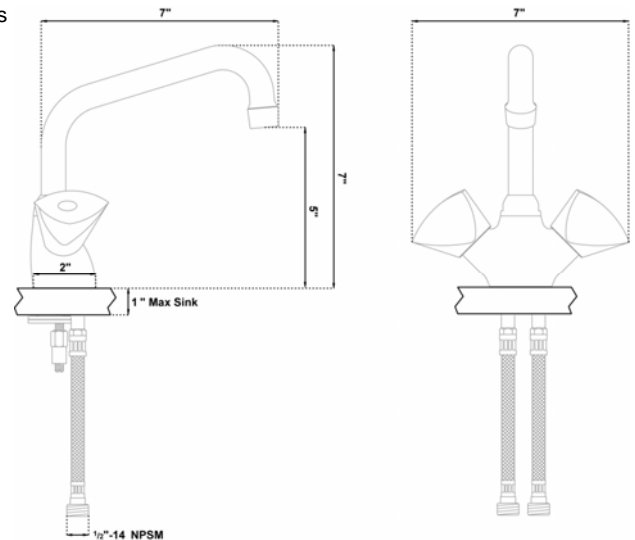

PROPER FINISH CARE:

Your new faucet is protected by a clear-coat. To clean it, you only need to wipe it with a damp, soft cloth. NEVER use any abrasive cleaners, steel wool, or chemicals, as they will harm the finish and void your warranty. If the faucet will be installed in a salt-air environment (boat exterior), regular cleaning with gentle soap and carnauba wax will prolong the life of the finish.

LIMITED WARRANTY

SHURflo Marine Grade Faucets & Accessories are guaranteed to be free from material and workmanship defects under normal use and service for a period of three (3) years from the date of manufactured vessel for all indoor applications and two (2) years from the date of manufactured vessel for all outdoor applications. This limited warranty will not apply to faucets or accessories that were improperly installed, misapplied, or incompatible with components not manufactured by SHURflo. Faucet failure due to foreign debris is not covered under the terms of this limited warranty. SHURflo will not warrant any faucet that is physically damaged, or altered outside the SHURflo factory. Warranty claims may be resolved by a SHURflo service center. All returns are to be shipped with charges pre-paid. Package all returns carefully. SHURflo will not be responsible for freight damage incurred during shipping to a service center. SHURflo's obligation under this warranty policy is limited to the repair or replacement of the faucets & accessories. Faucets or accessories found not defective (under the terms of this limited warranty) are subject to charges to be paid by the returnee for the testing and packaging of "tested good" units. Warranty returns will be shipped on a freight allowed basis. SHURflo reserves the right to choose the method of transportation. SHURflo is not responsible nor will it reimburse for labor necessary to remove and reinstall a faucet or accessory, if found defective. This warranty is only a representation of the complete Marine Products Limited Warranty outlined by Service Bulletin #1050.

★ SHURflo reserves the right to update specifications, prices, or make substitutions.



SHURflo*
5900-A Katella Ave.
Cypress, CA 90630
(562) 795-5200 (800) 854-3218
FAX (562) 795-7564
Shipping: 5900-C Katella Ave.
Cypress, CA 90630

SHURflo East
52748 Park Six Court
Elkhart, IN 46514-5427
(574) 262-0478 (800) 762-8094
FAX (574) 264-2169
<http://www.shurflo.com>

SHURflo Ltd.*
Unit 5 Sterling Park
Gatwick Road, Crawley
West Sussex, RH10 2QT
United Kingdom
+44 1293 424000
FAX +44 1293 421880

