

SHURflo[®] Marine Grade Faucets

INSTALLATION INSTRUCTIONS

OEM Version

Attention Manufacturers:
Please include this Installation
Instruction sheet with your Owner's
Documentation.



134-0102-CP

Stasis
Single Handle Shower
Chrome

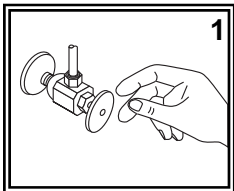

- (1) Turn off the water supply to your existing faucet (this procedure will vary depending on the specific plumbing system installed on your boat).

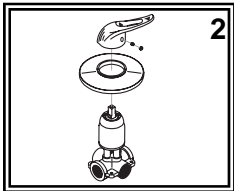

- (2) Remove handle and wall plate from valve assembly. Remove the blue/red cap and loosen the set screw behind it. Slide handle off the cartridge. Slide wall plate off the trim sleeve. Be careful not to damage the wall plate gasket.

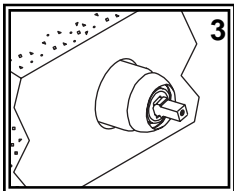

- (3) From the back side of the bulkhead, slide the valve assembly through the hole in the bulkhead. Note that the brass valve is stamped with "UP". Make sure that the "UP" is on the top side when positioned.

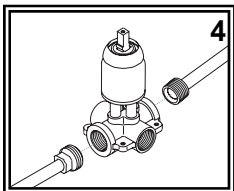

- (4) Connect hot/cold water supply lines (not provided) to the inlet tubes. The inlet tubes are the 1/2" NPT-Female tubes on the left and right sides of the valve. Wrap the fittings with Teflon (Plumber's) tape. This procedure will vary depending on the specific plumbing system installed on your boat.

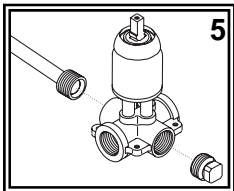

- (5) Connect 1/2" NPT water line from the shower head or bulkhead elbow (not included) to the shower head (top) port. Wrap the fitting on the water line with Teflon (Plumber's) tape. Thread tub port plug into the tub port (bottom) (if you are not using a tub spout with this installation). Wrap the plug with Teflon (Plumber's) tape.

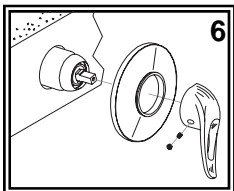

- (6) Replace handle and wall plate onto valve assembly. Slide wall plate back onto the trim sleeve. Be careful not to damage the wall plate gasket. Tighten the handle screw and replace the blue/red cap. It may be necessary to secure the valve inside the wall to prevent movement. This procedure will vary depending on the specific design of your boat. Suggestions: Use the screw-holes molded into the valve. Use strapping material. Wedge item in place.

- (7) After installation is complete, turn the water supply back on and allow both hot and cold water to run for at least one full minute. While water is running, check all connections for leaks. Connections may need re-tightening.

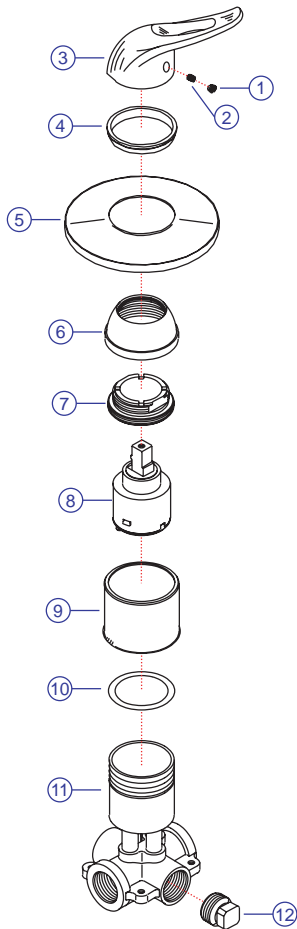

Parts

- 1) Blue/Red Cap
- 2) Handle Screw
- 3) Stasis Handle
- 4) Wall Plate Gasket
- 5) Wall Plate
- 6) Cap
- 7) Retainer Ring
- 8) Ceramic Disc Cartridge
- 9) Trim Sleeve
- 10) O-Ring
- 11) Valve
- 12) Tub Port Plug

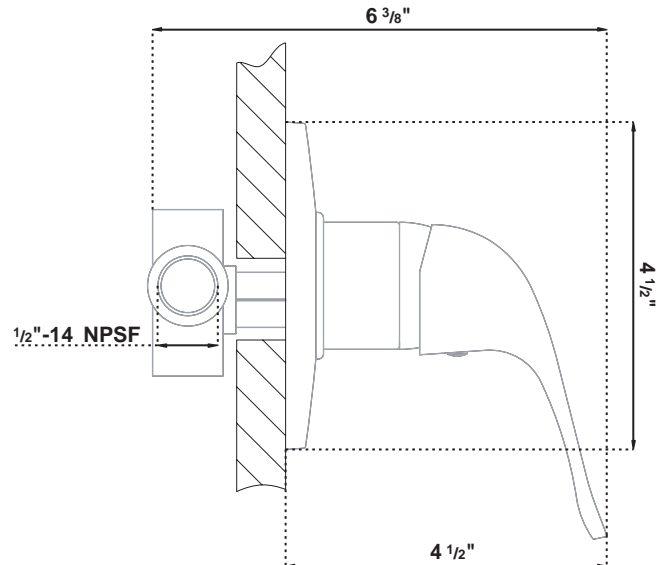

PROPER FINISH CARE:

Your new faucet is protected by a clear-coat. To clean it, you only need to wipe it with a damp, soft cloth. NEVER use any abrasive cleaners, steel wool, or chemicals, as they will harm the finish and void your warranty. If the faucet will be installed in a salt-air environment (boat exterior), regular cleaning with gentle soap and carnauba wax will prolong the life of the finish.

LIMITED WARRANTY

SHURflo Marine Grade Faucets & Accessories are guaranteed to be free from material and workmanship defects under normal use and service for a period of three (3) years from the date of manufactured vessel for all indoor applications and two (2) years from the date of manufactured vessel for all outdoor applications. This limited warranty will not apply to faucets or accessories that were improperly installed, misapplied, or incompatible with components not manufactured by SHURflo. Faucet failure due to foreign debris is not covered under the terms of this limited warranty. SHURflo will not warrant any faucet that is physically damaged, or altered outside the SHURflo factory. Warranty claims may be resolved by a SHURflo service center. All returns are to be shipped with charges pre-paid. Package all returns carefully. SHURflo will not be responsible for freight damage incurred during shipping to a service center. SHURflo's obligation under this warranty policy is limited to the repair or replacement of the faucets & accessories. Faucets or accessories found not defective (under the terms of this limited warranty) are subject to charges to be paid by the returnee for the testing and packaging of "tested good" units. Warranty returns will be shipped on a freight allowed basis. SHURflo reserves the right to choose the method of transportation. SHURflo is not responsible nor will it reimburse for labor necessary to remove and reinstall a faucet or accessory, if found defective. This warranty is only a representation of the complete Marine Products Limited Warranty outlined by Service Bulletin #1050.

★ SHURflo reserves the right to update specifications, prices, or make substitutions.



SHURflo*
5900-A Katella Ave.
Cypress, CA 90630
(562) 795-5200 (800) 854-3218
FAX (562) 795-7564
Shipping: 5900-C Katella Ave.
Cypress, CA 90630

SHURflo East
52748 Park Six Court
Elkhart, IN 46514-5427
(574) 262-0478 (800) 762-8094
FAX (574) 264-2169
<http://www.shurflo.com>

SHURflo Ltd.*
Unit 5 Sterling Park
Gatwick Road, Crawley
West Sussex, RH10 2QT
United Kingdom
+44 1293 424000
FAX +44 1293 421880

