INSTRUCTION GUIDE

- STEP-BY-STEP ILLUSTRATED INSTALLATION INSTRUCTIONS
 - TROUBLE SHOOTING & REPAIR TIPS
 - 20 YEAR LIMITED WARRANTY
 - PROPER FINISH CARE

⇒ Read these instructions carefully before installing your new faucet ⇐



Ambassador[®]
FINE FAUCETS



4" CENTER SET LAV.
Cleopatra Series

For Model:

317-3311

With
STANDARD CARTRIDGE
Valves

BEFORE YOU BEGIN

Your new Ambassador faucet will give you years of trouble-free performance. Thank you for choosing our product for your home. Please read these instructions carefully before installing your new faucet.

Helpful items to install this faucet:

- a basin wrench
- adjustable wrench or pliers (2x)
- towel
- 2 rubber cone washers (for water supply lines)
- plumber's putty
- goggles
- flashlight

IMPORTANT POINTS TO REMEMBER

- When installing your new faucet, turn the connector nuts finger-tight, then use one wrench to hold the fitting and a second wrench to tighten the connection.

CAUTION: Connections that are too tight will reduce the integrity of the system.

- Wrap all threaded connections with Teflon tape which is supplied with this faucet. Always wrap in a clockwise direction.

PROPER FINISH CARE

PROPER FINISH CARE

YOUR NEW FAUCET IS PROTECTED BY A CLEAR-COAT. TO CLEAN IT, YOU ONLY NEED TO WIPE IT WITH A DAMP, SOFT CLOTH. NEVER USE ANY ABRASIVE CLEANERS, STEEL WOOL, OR CHEMICALS, AS THEY WILL HARM THE FINISH AND VOID YOUR WARRANTY. FOR ADDITIONAL CLEANING HELP, CALL OUR CUSTOMER SERVICE CENTER.

REMOVAL OF EXISTING FAUCET

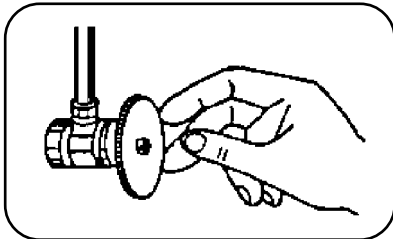

(1) Turn off water supply under sink. Cover the sink drain to prevent the loss of small parts. Remove old faucet, taking care not to damage existing water lines. If you need additional assistance with the removal of your existing faucet, consult that faucet's owner's manual or its manufacturer. Clean sink area in preparation for new faucet.

4" CENTER SET LAV. CLEOPATRA SERIES

1) Handle Tip
10841CP (Chrome)
10841YP (Dura-Life Finish™)

2) Handle Canopy
01852ST

3) Set Screw
00803-1

4) Blue/Red Cap
02846H (Hot)
02846C (Cold)

5) Handle Screw
00844CP

6) Adapter
11014H (Hot)
11014C (Cold)

7) Retainer Nut
01602CP

8) Cartridge
50703NH (Hot)
50703NC (Cold)

9) Packing Ring
20013

10) Cover
00734ST

11) Seat
10100N

12) Spring
00500

13) Valve Body
04474N-13

14) Gasket
01138

15) Thumb Nut
00907

16) Connector Nut
00916

17) Aerator
50019NCP-66 (Chrome)
50019NYP-66 (Dura-Life Finish™)

18) Bottom Plate
22307ST

19) Screw
00817CP

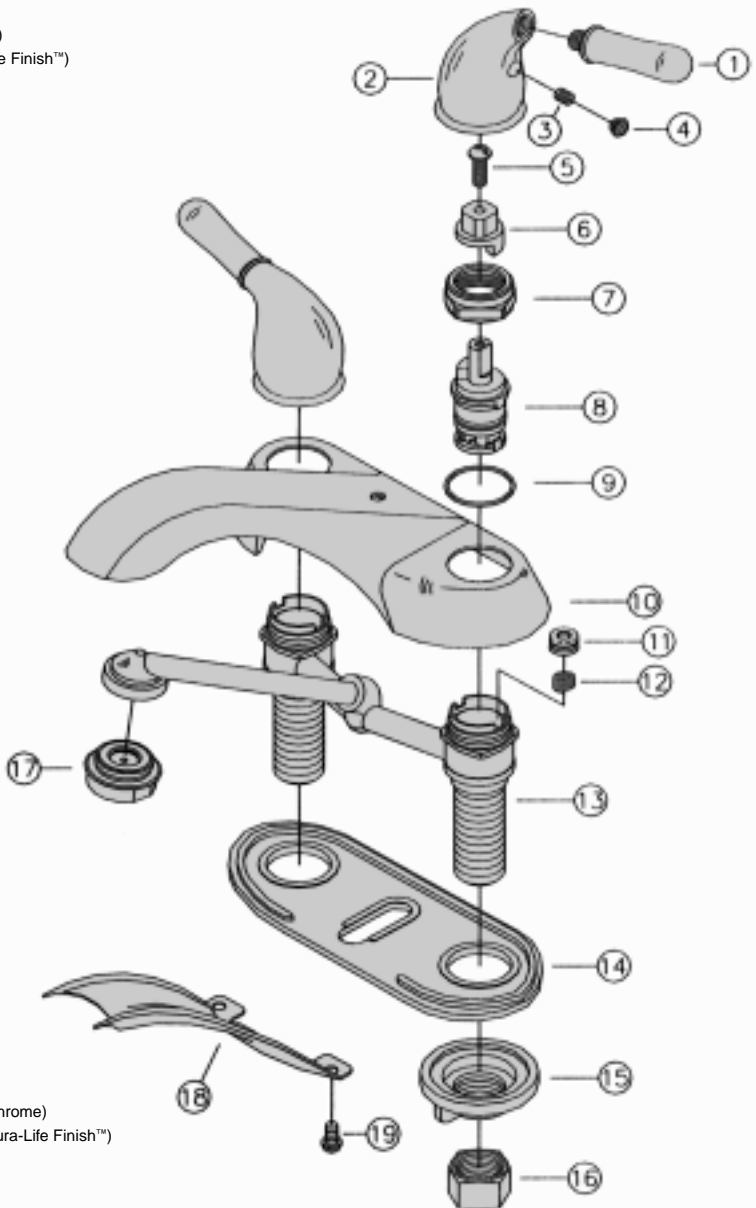

Model 317-3311

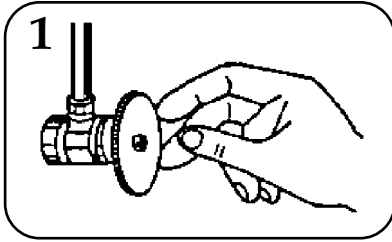

(1) Make sure water supply lines under sink are turned off. Inspect condition of supply lines. Cover the sink drain to prevent the loss of small parts. Make sure sink area is clean in preparation for new faucet.

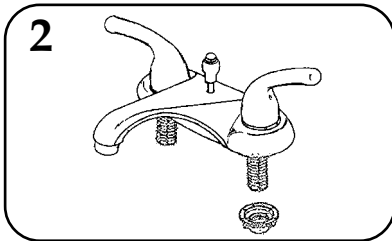

(2) Place your new faucet through the holes in your sink. Make sure the black gasket properly lines up with the base of the faucet. From under the sink, tighten the black plastic thumb nuts. You may need to use a wrench to properly secure them. Be careful not to crack or break the thumb nuts or brass valve body if using a wrench. Watch that the faucet is lined up straight on the sink while tightening nuts.

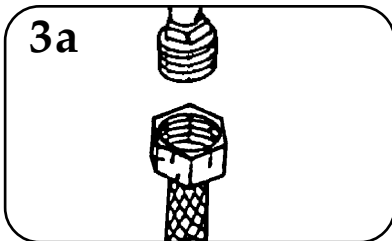

(3) Connect water supply lines (not provided) to the faucet. Wrap the brass threaded valve ends with Teflon tape. Follow the appropriate steps below depending on your water supply lines.

(3a) If you have pre-assembled vinyl or braided metal water supply hoses, simply connect hot supply hose to valve body. Repeat for cold side.

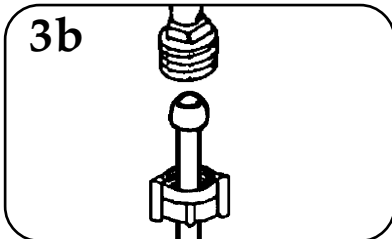

(3b) If you have plastic water lines with formed ends, you will not need to use rubber cone washers. Water lines will seat partially up into the brass valve body ends. Connect by tightening the brass coupling nuts.

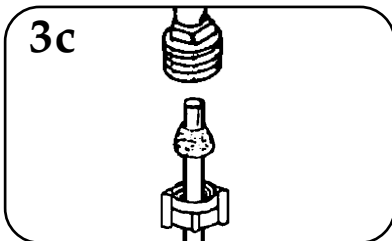

(3c) If you have 3/8" or 1/2" metal supply lines, assemble as illustrated. Slide the coupling nuts onto the lines. Place the appropriate size brass washer inside the nuts and slide the appropriate size black cone washer (not provided) onto the metal line (approx. 1/3" to 1/2" back from the end of the line). Flare the end of water supply line to avoid blow-outs. Water lines will seat partially up into the brass valve body ends. Connect by tightening the brass coupling nuts.

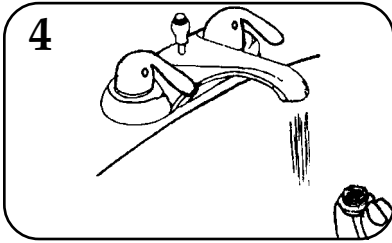

(4) After installation is complete (including pop-up drain), remove the aerator. Be careful not to scratch the finish. Turn the water supply back on and allow both hot and cold water to run for at least one full minute. While water is running, check all connections for leaks. Replace aerator. Nuts may need re-tightening. If leaks persist, refer to **TROUBLE SHOOTING & REPAIR TIPS**.



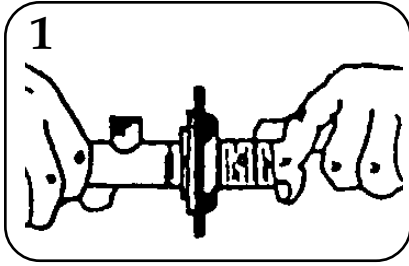

(1) Unscrew flange from drain body. Leave large black washer, white friction ring and locknut on drain body.

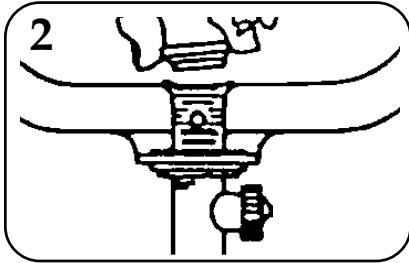

(2) Place a ring of putty around the drain hole in your sink. Insert the threaded end of the drain body up through the drain hole and attach the flange to the body, with the pivot ball nut pointing to the rear of the sink.

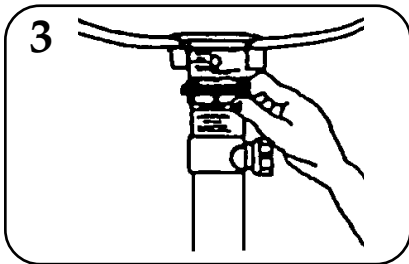

(3) Tighten the locknut from under the sink until the black rubber washer seats securely inside the sink drain hole. Wipe away excess putty. Tighten brass locknut with a wrench.

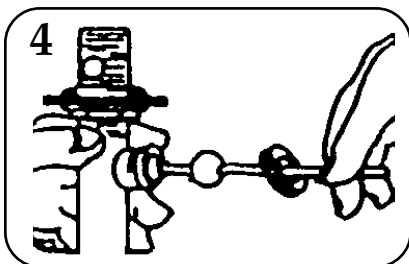

(4) Set the drain plunger in place (see "DRAIN PLUNGER" below). Unscrew the pivot ball nut from the pop-up body and remove the spring clip from the pivot ball rod. Leave the white packing ring on and slide the ball nut onto the rod covering the white packing ring. Insert the rod into the hole on the back of the pop-up body. Slide the ball nut in place and tighten securely.

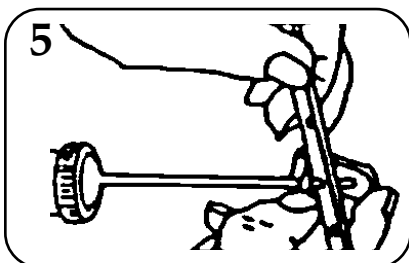

(5) Slide one end of the spring clip onto the end of the pivot rod. Insert the pivot rod into one of the lower holes in the lift rod strap. Secure other end of spring clip onto pivot rod.

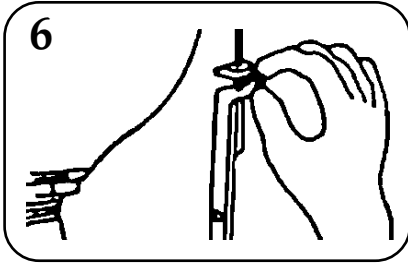

(6) Drop the lift rod down through hole in faucet. Insert bottom of lift rod into hole on the top of the lift rod strap (see “**ADJUSTING THE LIFT ROD**” below). Tighten with thumb screw.

ADJUSTING THE LIFT ROD

Adjust lift rod function by adjusting the height of the thumb screw along the lift rod (step 6) or by changing the hole that the pivot rod goes through on the lift rod strap (step 5).

Be sure to leave enough space between the lift rod knob and the faucet spout when the rod is down.

DRAIN PLUNGER

There is a small square cutout at the bottom of the drain plunger. That square needs to go down the front of the drain body (opposite side from the pivot ball nut). The pivot rod passes through that square to lock the drain plunger in and form a tight seal when drain is closed.

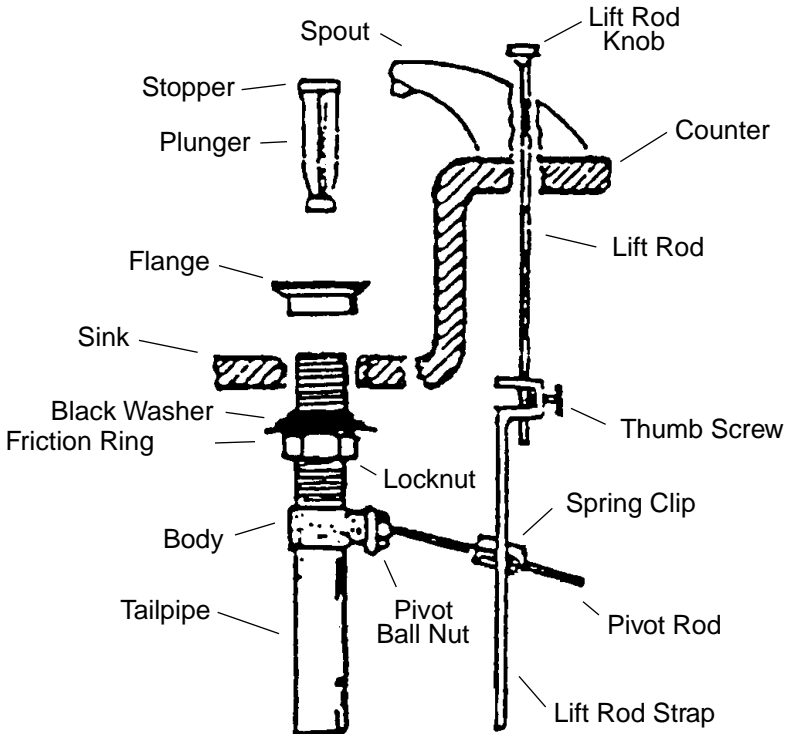

TROUBLE SHOOTING & REPAIR TIPS

If maintenance is ever called for, you can repair your faucet in minutes. Simply identify the problem below and take these corrective steps. If your problem is not listed, or you need additional help, call our Customer Service Center. It's that easy!

PROBLEM

Water leaks from underneath handle.

CAUSE

Retainer nut has come loose or the o-ring on the cartridge is dirty or damaged.

SOLUTION

(1) Remove the handle. (Diagram A)

(2) Tighten the retainer nut by turning it clockwise. (Diagram B) Rotate the valve cartridge to the "ON" position and check for leaks.

(3) If the leak continues, turn off the water supply. Remove the retainer nut by turning it counter-clockwise. Lift out the cartridge. (Diagram C) Inspect the o-ring on the outside of the cartridge. Remove any debris from the o-rings. If it is twisted, straighten it out. If the o-ring is damaged, replace the cartridge.

(4) Place the cartridge back in the valve body. (Diagram C) Make sure the wings on the two sides of the cartridge fit into the cuts on the two sides of the valve body. Retighten the retainer nut onto the valve body. Reassemble the handle. Turn the water back on.

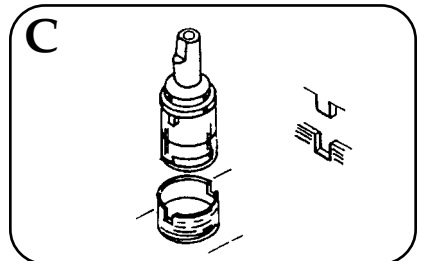
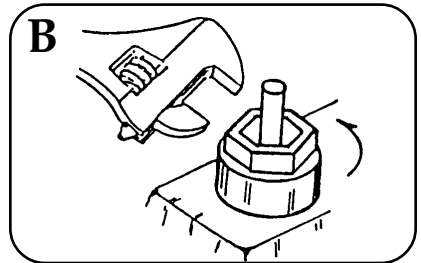
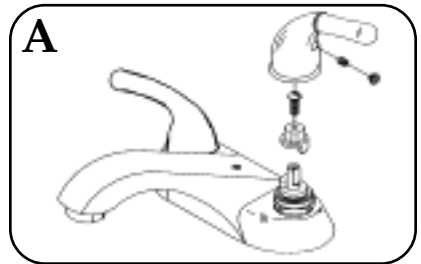

TROUBLE SHOOTING & REPAIR TIPS

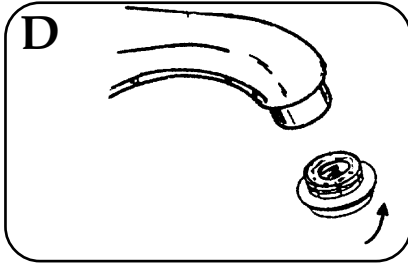

PROBLEM

Aerator leaks from connection or has an improper flow pattern.

CAUSE

Aerator is misseated or has debris in the assembly.

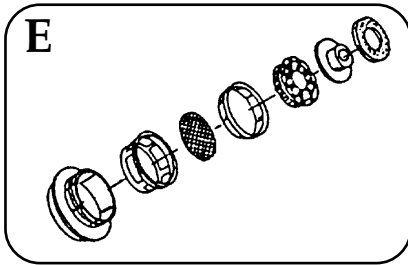

SOLUTION

Unscrew the aerator. (Diagram D) **BE CAREFUL NOT TO SCRATCH THE FINISH.** Inspect the black rubber packing and small parts. Clear away any debris. Make sure to reassemble it as per the exploded picture. (Diagram E) Replace aerator.

PROBLEM

Water does not completely shut off (drips).

CAUSE

Retainer nut has come loose or the rubber valve seat is dirty, worn, or damaged.

SOLUTION

(1) Turn off the cold water under the sink. If leak stops, the problem is with the cold side. If leak continues, turn off the hot side in order to determine which side is the problem. Turn the water back on under the sink.

(2) Remove the handle on the problem side. (Diagram A) Tighten the retainer nut by turning it clockwise. (Diagram B) If drip does not stop, turn off the water under the sink. Remove the retainer nut by turning it counter-clockwise. (Diagram B) Lift out the cartridge. (Diagram C)

(3) Remove and inspect the rubber valve seat and spring. If there is debris on the surface of the seat, remove it. If the rubber seat is stuck in the water inlet hole, push it down gently with your fingertip so that it moves up and down smoothly, you may want to put a few drops of vegetable (cooking) oil onto the seat to help lubricate it. The spring (smaller end up) must be placed underneath the rubber seat. If the rubber valve seat is worn or damaged, replace it with a new one. Replacement parts are available at your local hardware or plumbing supply store.

(4) Place the cartridge back in the valve body. (Diagram C) Make sure the wings on the two sides of the cartridge fit into the cuts on the two sides of the valve body. Retighten the retainer nut onto the valve body. Reassemble the handle. Turn the water back on.

MATCHING ITEMS (SEE CATALOG OR INTERNET FOR DETAILS)



4" CENTER SET

4" MINI-SPREAD



**1 HANDLE SHOWER/TUB
(PRESSURE BALANCE)**



6-12" WIDESPREAD



**3 HANDLE
SHOWER/TUB**



**2 HANDLE
SHOWER/TUB**

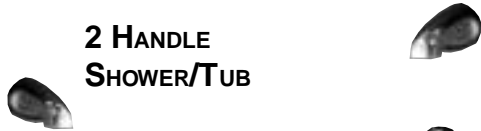

SOAP DISH



CUP/TOOTHBRUSH HOLDER



ROMAN/WHIRLPOOL TUB



WET BAR



**BATH ACCESSORY KIT
(ALSO AVAILABLE INDIVIDUALLY)**

20 YEAR LIMITED WARRANTY

LIMITED WARRANTY

The manufacturer warrants its control cartridges to the original purchaser to be free from defects in material or workmanship for a period of 20 years from the date of purchase found on the retail sales receipt, a copy of which is required for any warranty claims. The warranty on the finish of this product is for one year from date of purchase. Do not attempt to clean your faucet with any kind of chemical or abrasive cleaner. Any abrasive will mar the finish and void your warranty. All that is necessary is to wipe it with a clean, damp cloth.

**IF YOU NEED MORE INFORMATION CONCERNING
PARTS OR SERVICE DO NOT CONTACT YOUR
RETAILER, PLEASE CONTACT:**

**AMBASSADOR CUSTOMER SERVICE
1-800-270-4262**

Please be advised that this warranty does not cover labor, or other costs of installation, removal, repair, freight to or from the manufacturer, or reinstallation of faucets or parts. Further, this warranty is void when a defect or failure results from misuse, neglect, accident, improper installation, or modification of the faucet or parts, or as a result of work performed by other than the manufacturer.

This warranty is in lieu of all other expressed warranties. The sole and exclusive remedy against the maker hereunder shall be for repair or replacement of the faucet or parts, exclusively at the option of the manufacturer. Further, the manufacturer cannot issue refunds for products not purchased directly from the manufacturer. In no event will the maker or its agents be liable for incidental or consequential damages arising out of the purchase or use of this faucet.

If your state does not allow the exclusion or limitation of incidental or consequential damages the above limitations may not apply to you. This warranty gives you certain legal rights which may vary from State to State.



Ambassador[®]

FINE FAUCETS

IF YOU HAVE ANY PROBLEMS,
DO NOT CONTACT YOUR RETAILER
FOR SERVICE OR PARTS.

CALL OUR CUSTOMER SERVICE CENTER.

FOR QUESTIONS, SERVICE,
OR REPLACEMENT PARTS CALL:

1-800-270-4262

9:00 AM - 5:00 PM Pacific Time

Monday - Friday

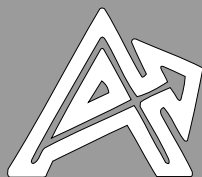

ASSOCIATED MARKETING CONCEPTS
CUSTOMER SERVICE WAREHOUSE
21624 MARILLA STREET
CHATSWORTH, CA 91311-4123
www.ambassador-amc.com