

REV. CHANGE	
A	Ambassador Branded
B	Refreshed

136-0044-xx

www.ambassadormarine.com
800.270.4262

© Ambassador Marine, Inc.

Ambassador
MARINE

Rev #	B	Package Style	OEM	Model #	136-0044-xx
ERP #	N/A	Approved/Modified	04/28/2020	Series	Universal
Drawn By	SS	Type	Recessed Shower		

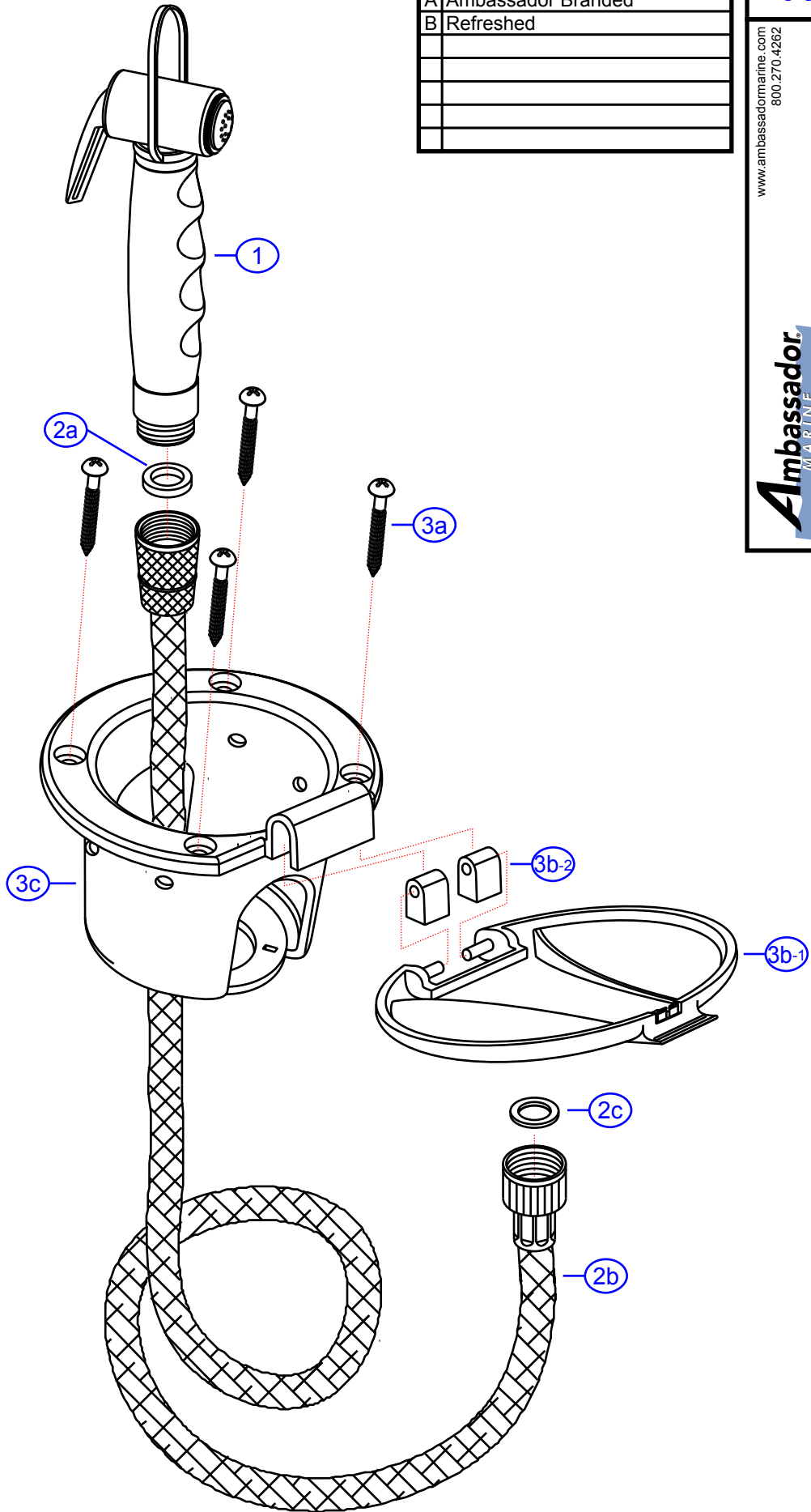

NOT DRAWN TO SCALE

