

Rev. Change

A	Ambassador branded
B	Spring-Clip Latch
C	Add Bag Rivet Holes
D	

136-0047-xx

by Associated Marketing Concepts
www.ambassadormarine.com
(800) 270-4262

Ambassador
MARINE

Rev #	C	Package Style	OEM	Model #	136-0047-xx
Vendor #			N/A	Series	Universal
Drawn By	SS		Approved/Modified	Type	Recessed Shower
					09/17/12

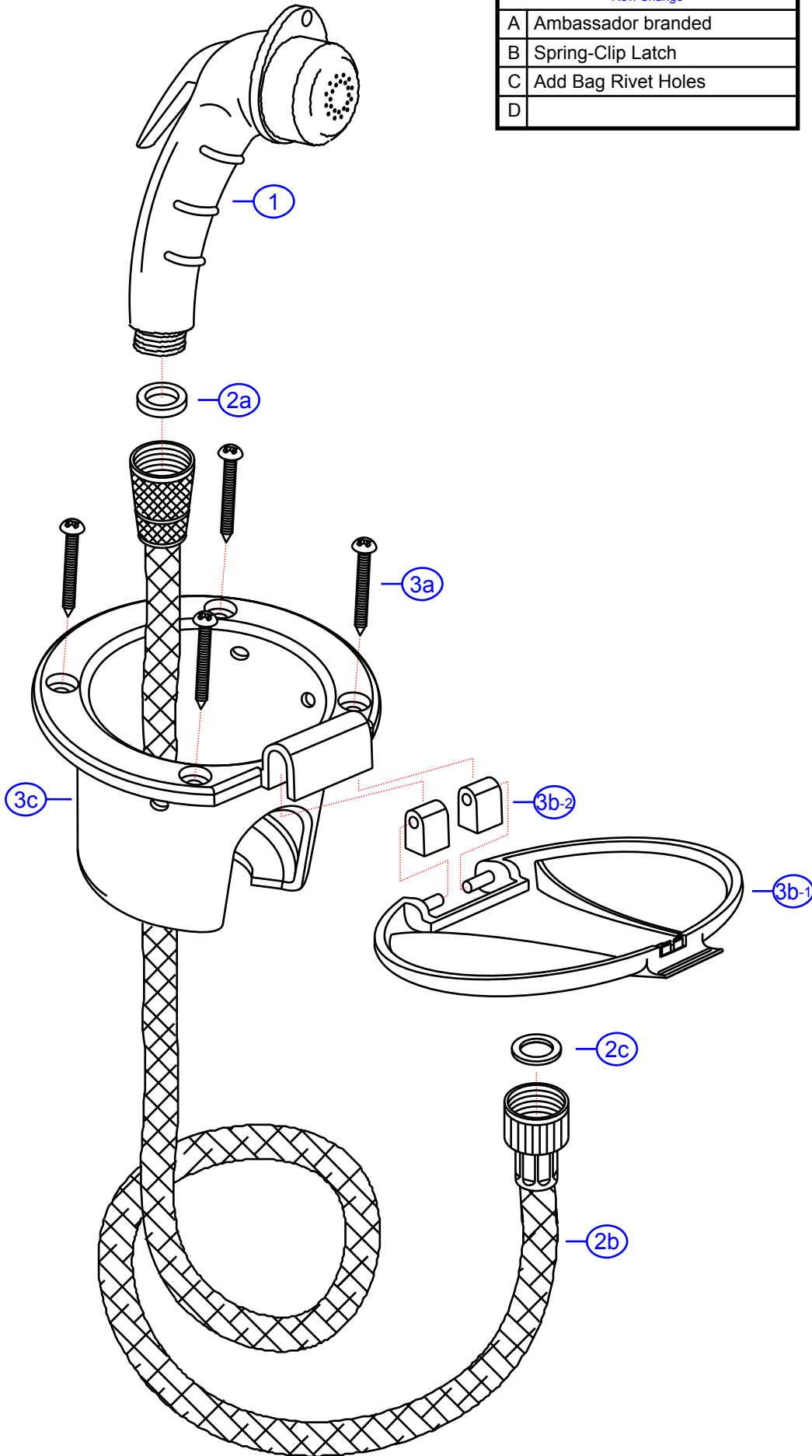

NOT DRAWN TO SCALE

