

REV. CHANGE

A	Ambassador Branded
B	Spring-Clip Latch
C	Add Bag Rivet Holes
D	Add Cup Bottom Ring
E	Refreshed

136-0047-xx

www.ambassadormarine.com
800.270.4262

© Ambassador Marine, Inc.

Ambassador
MARINE

Rev #	E	Package Style	OEM	Model #	136-0047-xx
ERP #	N/A	Approved/Modified	04/28/2020	Series	Universal
Drawn By	SS	Type	Recessed Shower		

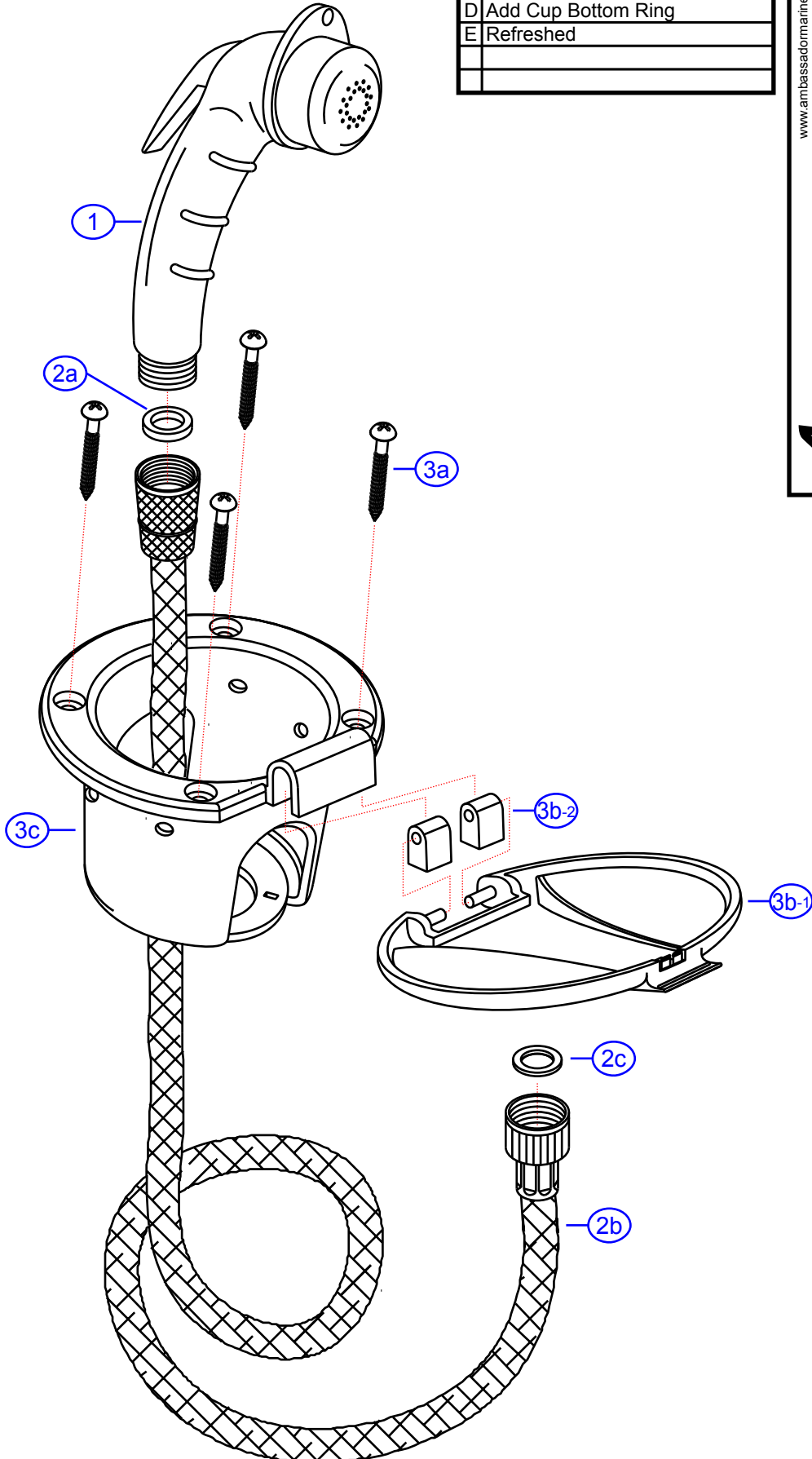

NOT DRAWN TO SCALE

