

REV. CHANGE	
A	Ambassador Branded
B	Continuous Threads

S00-0109-xx

www.ambassadormarine.com
800.270.4262

© Ambassador Marine, Inc.

Ambassador
MARINE

Rev #	B	Package Style	OEM	Model #	S00-0109-xx
ERP #	S00-0109-xx	Series	2" Drain	Type	Trap Drain
Drawn By	SS	Approved/Modified	09/27/2024		

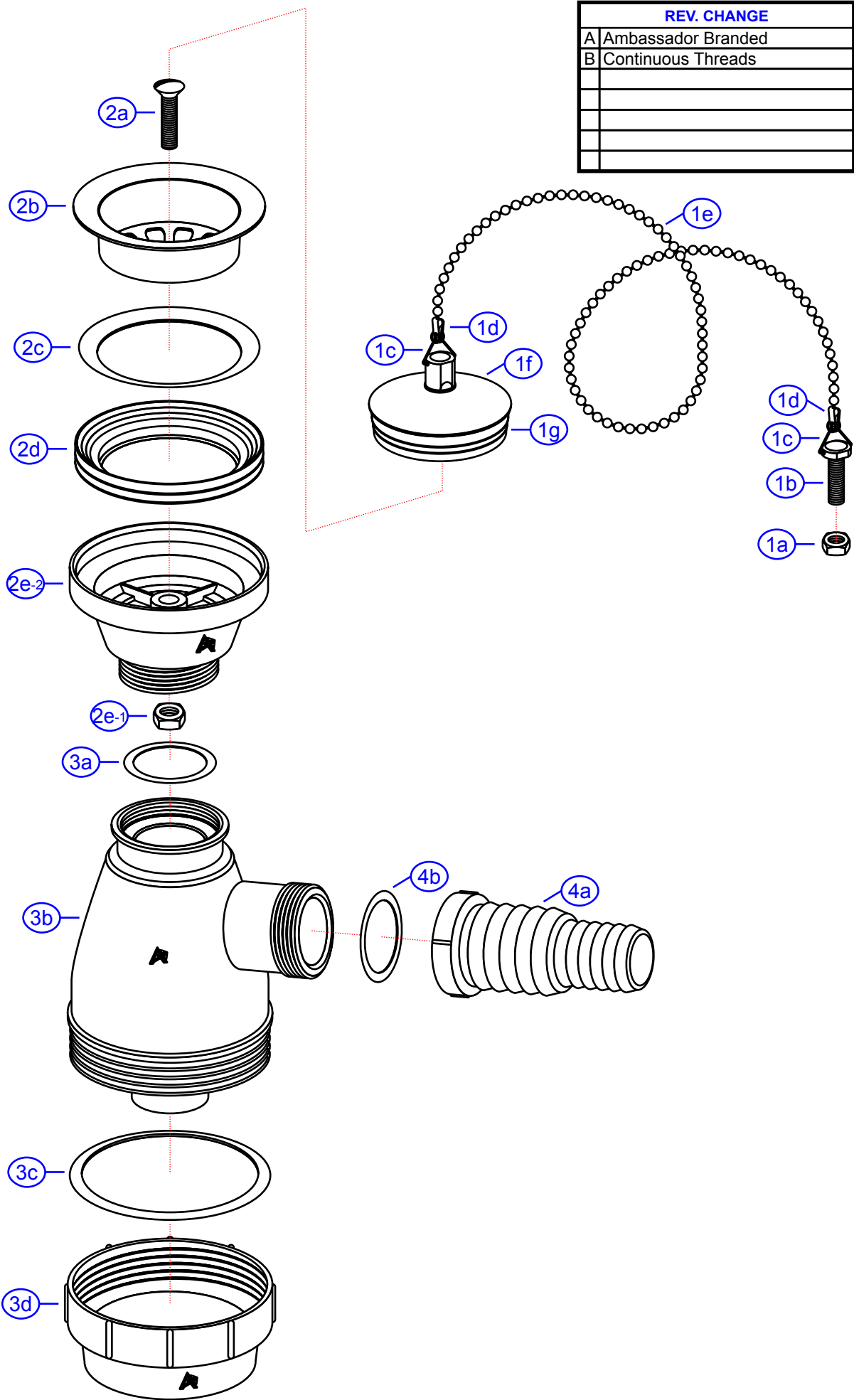

NOT DRAWN TO SCALE

