

V03-0716-xx

www.ambassadormarine.com
800.270.4262

© Ambassador Marine, Inc.

Ambassador MARINE

Rev #	B	Package Style	OEM	Model #	V03-0716-xx
ERP #				Series	1 1/4" Drain
Drawn By	SS	Approved/Modified	12/10/2024	Type	Touch Trap Drain

REV. CHANGE	
A	Ambassador Branded
B	Continuous Threads

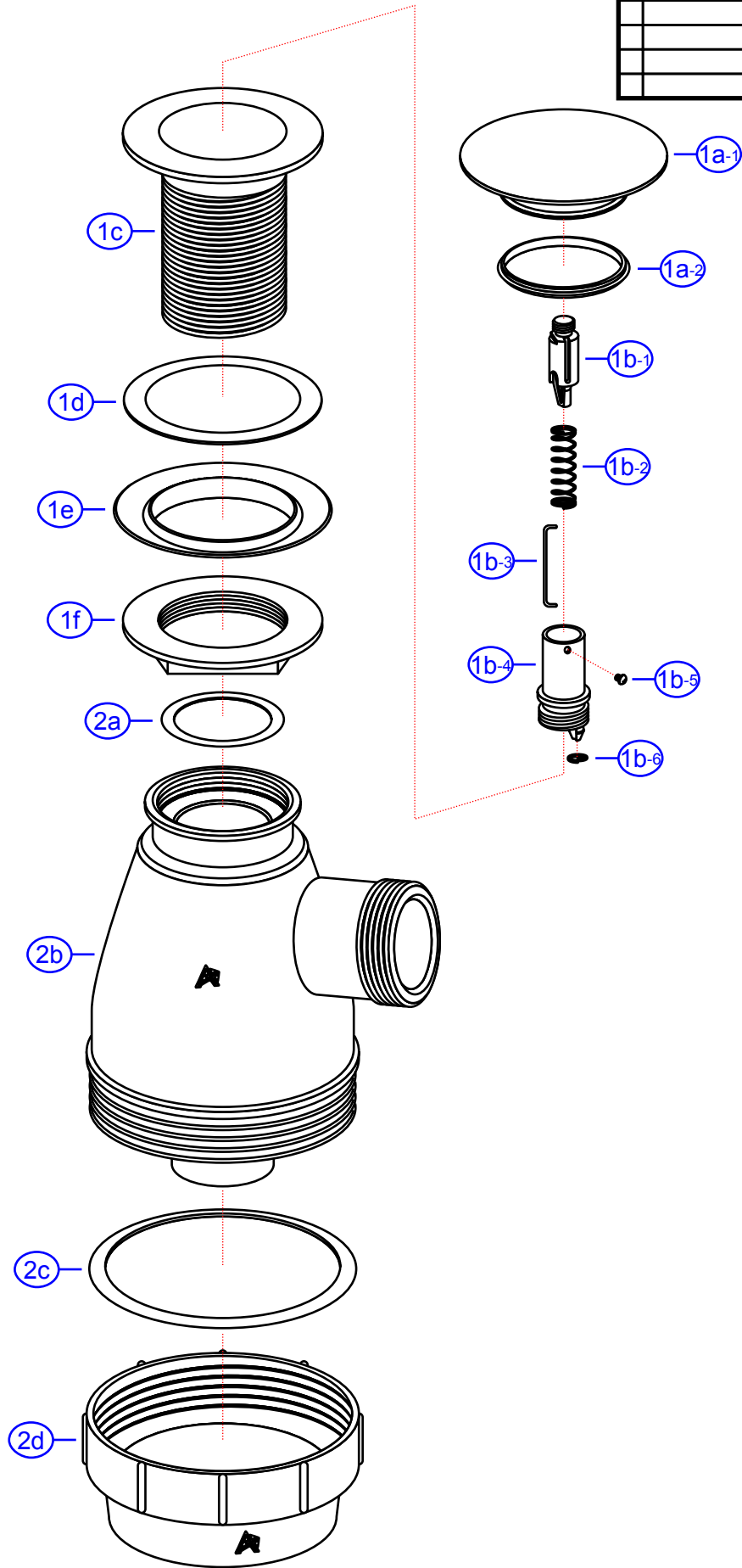

NOT DRAWN TO SCALE

