

317-3311

by Associated Marketing Concepts
21624 Manilla Street, Chatsworth, CA 91311-4123
(800) 270-4262 • (818) 678-1651 • FAX (818) 678-1655
www.ambassador-amc.com

Ambassador
FINE FAUCETS

By	SS	Main Finish	Satin	Model #	317-3311
Modified/Approved	1-8-04	Accent Finish	Dura-Life Finish & Chrome	Series	Cleopatra
Fulfillment	XXXXX	Valve	Standard (Washerless)	Type	4" Center Set Lav.

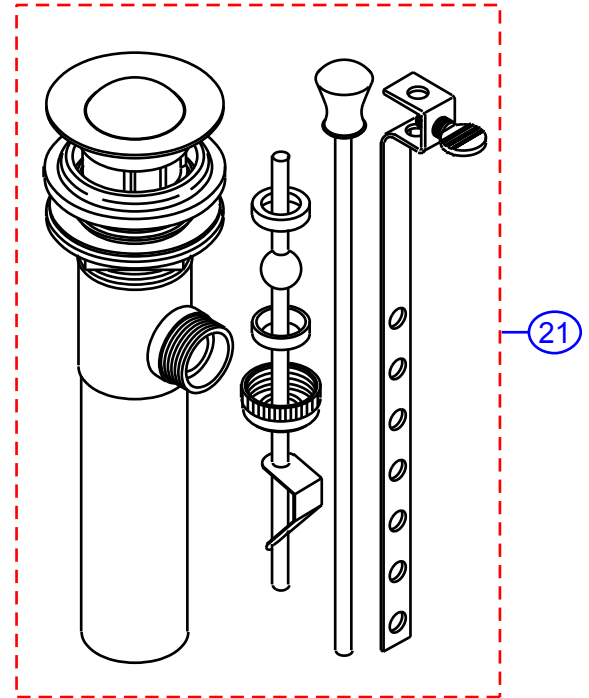
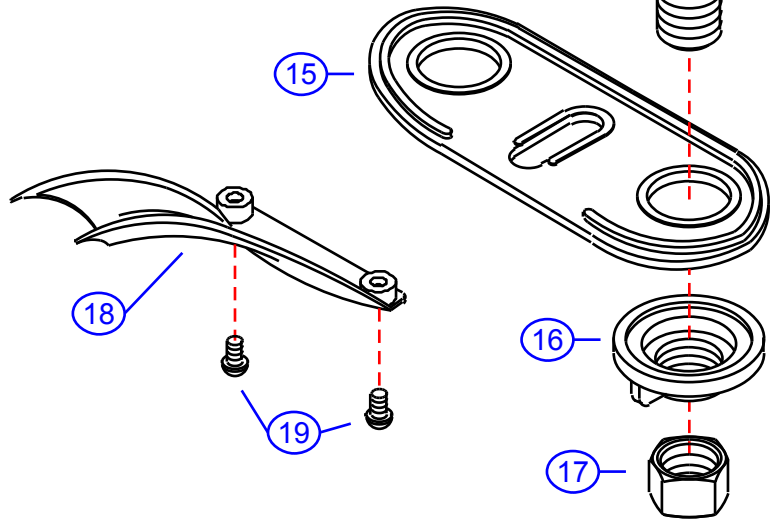
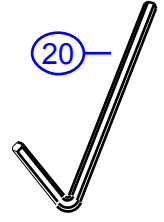
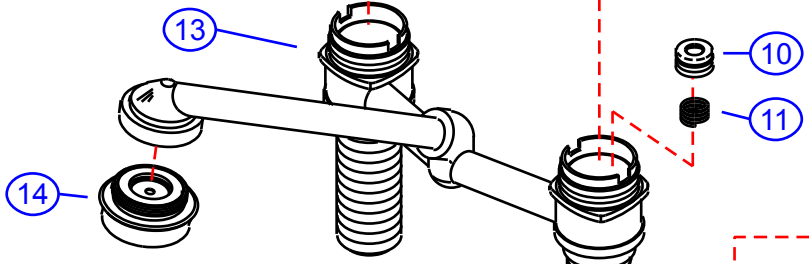
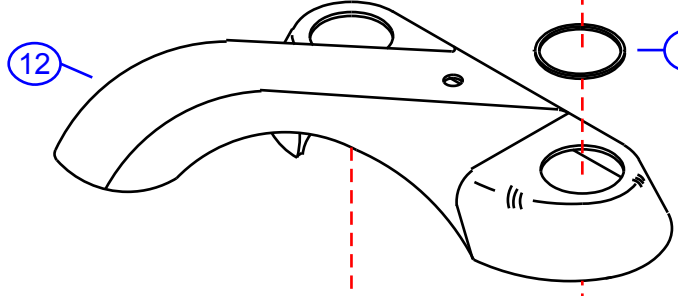
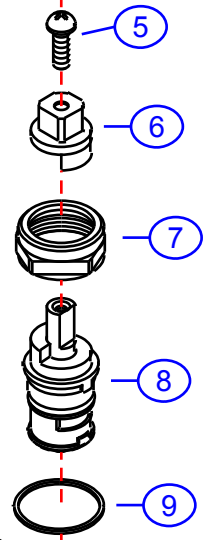
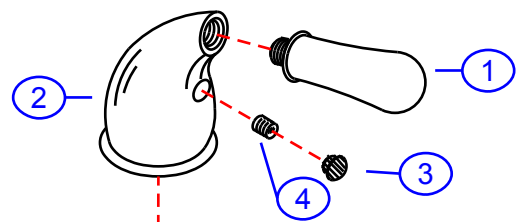
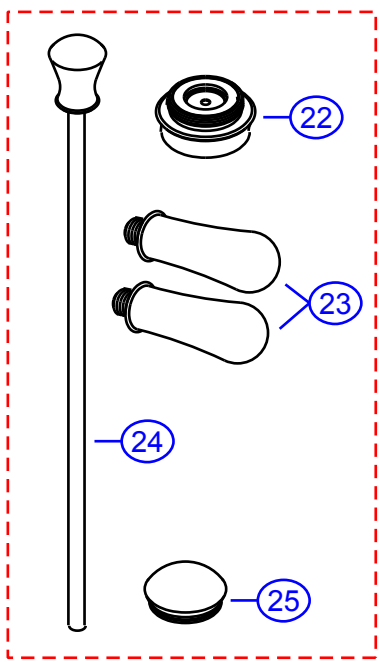

317-3311



Cleopatra 4" Center Set Lav- Std/SY/SC

#	Description	Quantity	Part #	Finish
1	Handle Tip	2	E-108041YP	Dura-Life Finish
2	Handle Canopy	2	E-018052ST	Satin
3	Red Plug	1	E-028046H	Rubber
	Blue Plug	1	E-028046C	Rubber
4	Set Screw	2	E-008003	Metal
5	Screw	2	E-008044CP	Chrome
6	Adapter (Hot)	1	E-110114H	Plastic
	Adapter (Cold)	1	E-110114C	Plastic
7	Retainer Nut	2	E-016002CP	Chrome
8	Cartridge	2	G-50743N	Plastic
9	Packing Ring	2	E-200013	Plastic
10	Seat	2	E-101000N	Rubber
11	Spring	2	E-005000	Metal
12	Cover Plate	1	E-007034ST	Satin
13	Valve Body	1	G-04474N-13	Brass
14	Aerator	1	E-500219NYP	Dura-Life Finish
15	Gasket	1	E-011038	Plastic
16	Thumb Nut	2	E-009007	Plastic
17	Connector Nuts	2	E-009016	Brass
18	Bottom Plate	1	E-223007ST	Satin
19	Screw	2	E-008017CP	Chrome
20	Allen Key	1	E-031000	Metal
21	Drain Kit (see "Drains" for parts)	1	EA-505039SY	Satin/Dura-Life Finish

ALSO INCLUDED IN BOX

22	Aerator	1	E-500219NCP	Chrome
23	Handle Tip	2	E-108041CP	Chrome
24	Lift Rod	1	E-025015CP	Chrome
25	Drain Stopper w/O-Ring	1	EA-028209CP	Chrome

* Grayed parts are not available individually. "Assembled" item required.

by Associated Marketing Concepts
21624 Marilla Street, Chatsworth, CA 91311-4123
(800) 270-4262 * (818) 678-1651 * FAX (818) 678-1655
www.ambassador-amc.com