

306-R

version 1

by Associated Marketing Concepts
 21624 Marilla Street, Chatsworth, CA 91311-4123
 (800) 270-4262 | (818) 678-1651 | FAX (818) 678-1655
 www.ambassador-amc.com

Ambassador
 FINE FAUCETS

By	SS	Main Finish	Chrome	Model #	306-R v1
Modified/Approved	2-16-04	Accent Finish	18k Gold	Series	Rope Ring
Fulfillment	xxxCG	Valve	Ceramic Disk	Type	3 Handle Shower/Tub

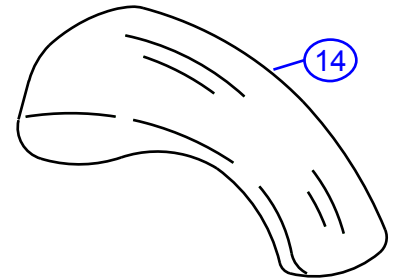
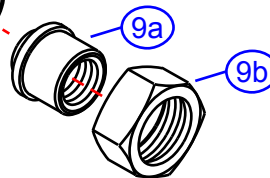
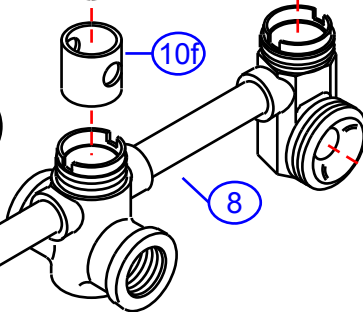
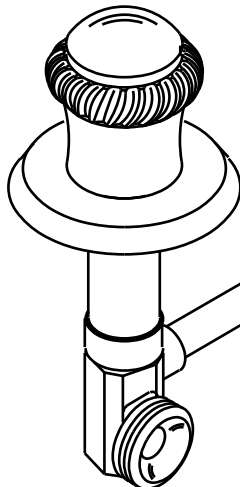
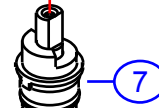
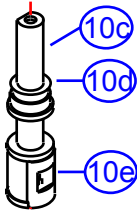
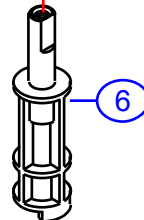
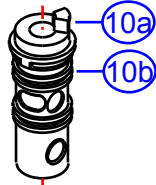
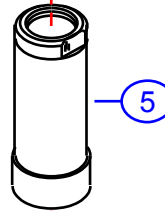
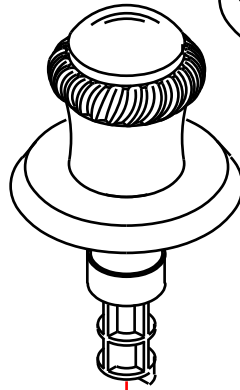
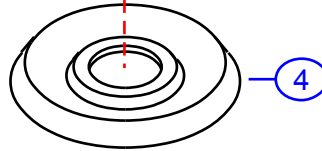
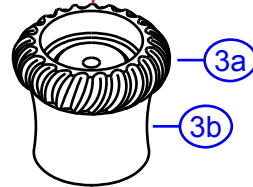
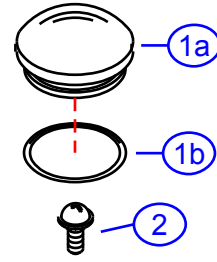
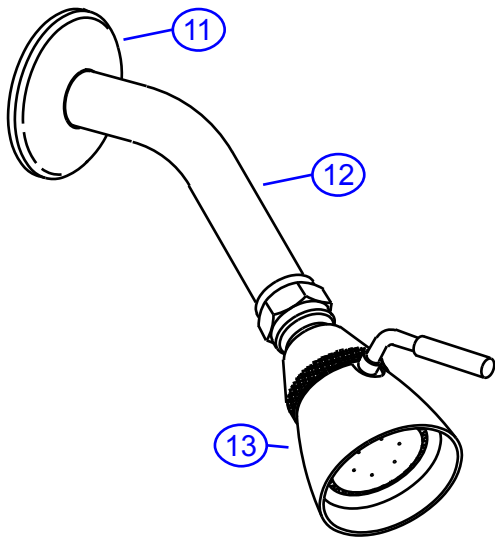

306-R v1



Rope Ring 3 Handle Shower/Tub- CD/CG

#	Description	Quantity	Part #	Finish
1	Cap w/O-ring	3	EA-663194CP	Chrome
1a	Cap	3	E-206049CP*	Chrome
1b	O-Ring	3	E-004053	Rubber
2	Handle Screw	3	E-008000	Metal
3	Rope Ring Widespread Handle	3	EA-667337CG	Chrome/Gold
3a	Trim Ring	3	E-218010GP*	Gold
3b	Handle Canopy	3	E-215006HCP*	Chrome
4	Escutcheon	3	E-111001GP	Gold
5	Retainer Nut	3	E-216000CP	Chrome
6	Stem Extention (Hot)	3	G-10003H	Plastic/Brass
7	Cartridge (Hot)	2	E-507003NH	Ceramic Disc
8	Valve	1	E-002067	Brass
9	Union Nut (Assembled)	2	EA-504100	Brass
9a	Union Sleeve	2	E-009028*	Brass
9b	Union Nut	2	E-009001*	Brass
10	Diverter Cartridge	1	EA-501016	Plastic
10a	Diverter Cartridge Housing	1	E-214008*	Plastic
10b	O-Ring	1	E-004037*	Rubber
10c	Diverter Cartridge Body	1	E-208023*	Plastic
10d	O-Ring	1	E-004011*	Rubber
10e	Diverter Cartridge Stopper	1	E-010047*	Plastic
10f	Diverter Cartridge Boot	1	E-010015*	Rubber
11	Shower Arm Escutcheon	1	E-019001GP	Gold
12	Shower Arm	1	E-020002GP	Gold
13	Shower Head	1	E-S11B0200CP	Chrome
14	Tub Spout	1	E-100015GP	Gold

* Grayed parts are not available individually. "Assembled" item required.

by Associated Marketing Concepts
 21624 Marilla Street, Chatsworth, CA 91311-4123
 (800) 270-4262 * (818) 678-1651 * FAX (818) 678-1655
www.ambassador-amc.com