

# 8106-J

by Associated Marketing Concepts  
 21624 Marilla Street, Chatsworth, CA 91311-4123  
 (800) 270-4262 | (818) 678-1651 | FAX (818) 678-1655  
 www.ambassador-amc.com

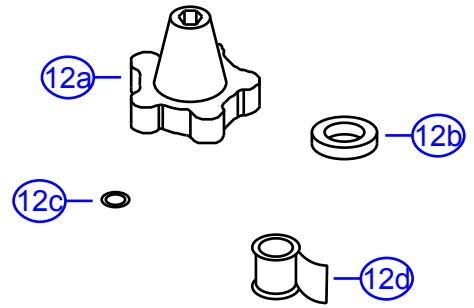

By	SS	Main Finish	Chrome	Model #	8106-J
Modified/Approved	4-1-04	Accent Finish	None	Series	6" Sunflower
Fulfillment	S113601CP	Valve	NA	Type	Shower Head

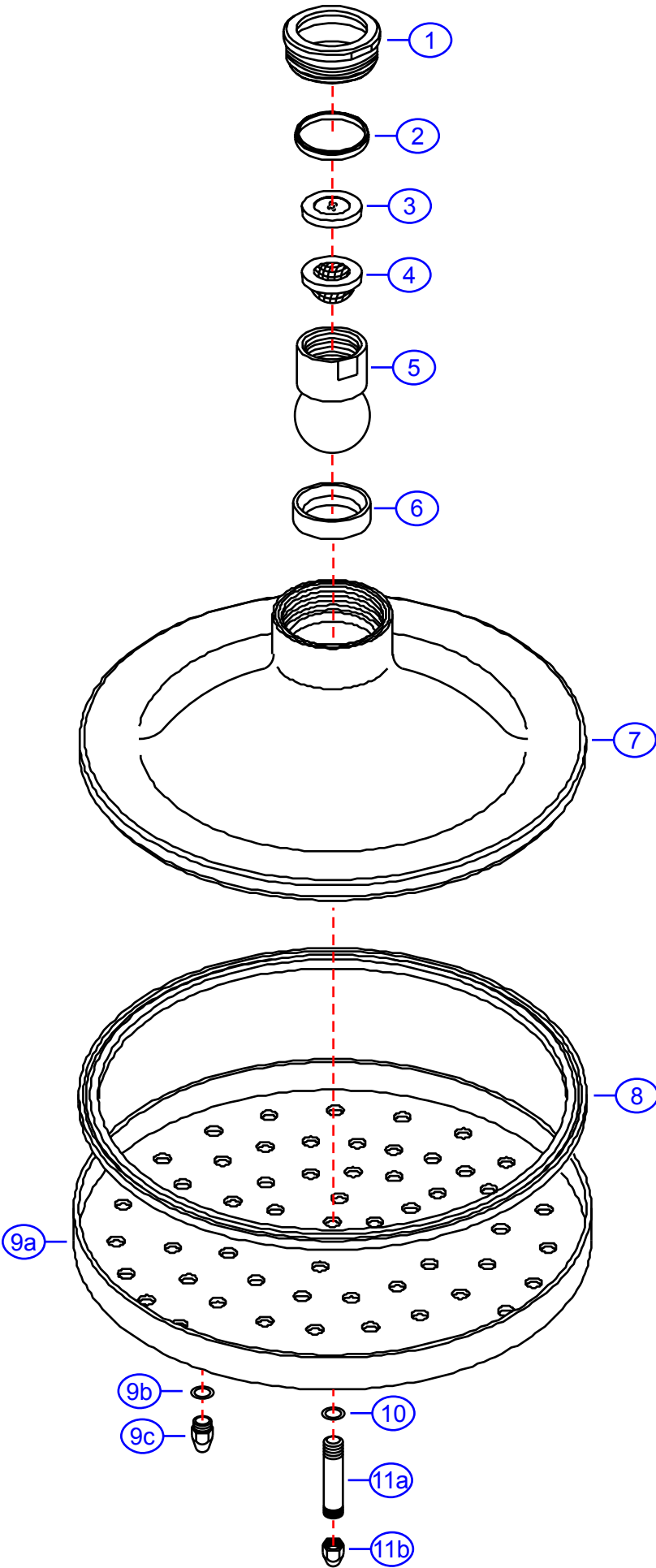

# 8106-J



## 6" Sunflower Shower Head- CP

#	Description	Quantity	Part #	Finish
1	Retainer Nut	1	E-054124CP*	Chrome
2	Packing Ring	1	E-060151*	Plastic
3	Water Restrictor	1	E-113011	Plastic
4	Washer	1	E-022028	Rubber
5	Ball Joint	1	E-057008CP*	Chrome
6	Gasket	1	E-058001	Rubber
7	Housing	1	E-055067CP*	Chrome
8	Gasket	1	E-058020	Rubber
9	Face Plate (Assembled)	1	EA-112111CP*	Chrome
9a	Face Plate	1	E-112139CP*	Chrome
9b	O-Ring	60	E-063037*	Rubber
9c	Nipple	60	E-112110CP*	Chrome
10	O-Ring	1	E-004058	Rubber
11	Face Screw (Assembled)	1	EA-053042CP	Chrome
11a	Screw Body	1	E-053083*	Metal
11b	Screw Head	1	E-053084CP*	Chrome
12	Sunflower Repair Kit	1	EA-504600	Plastic/Rubber
12a	Sunflower Tool	1	E-031008	Plastic
12b	Washer	1	E-058007	Rubber
12c	O-Ring	1	E-004058	Rubber
12d	Teflon Tape	1	E-203000	Tape

\* Grayed parts are not available individually. "Assembled" item required.