

Rev. Change

A	Ambassador branded
B	
C	
D	
E	
F	
G	



www.ambassadormarine.com
(800) 270-4262

Model # **130-1810-xx**

Rev # **A**

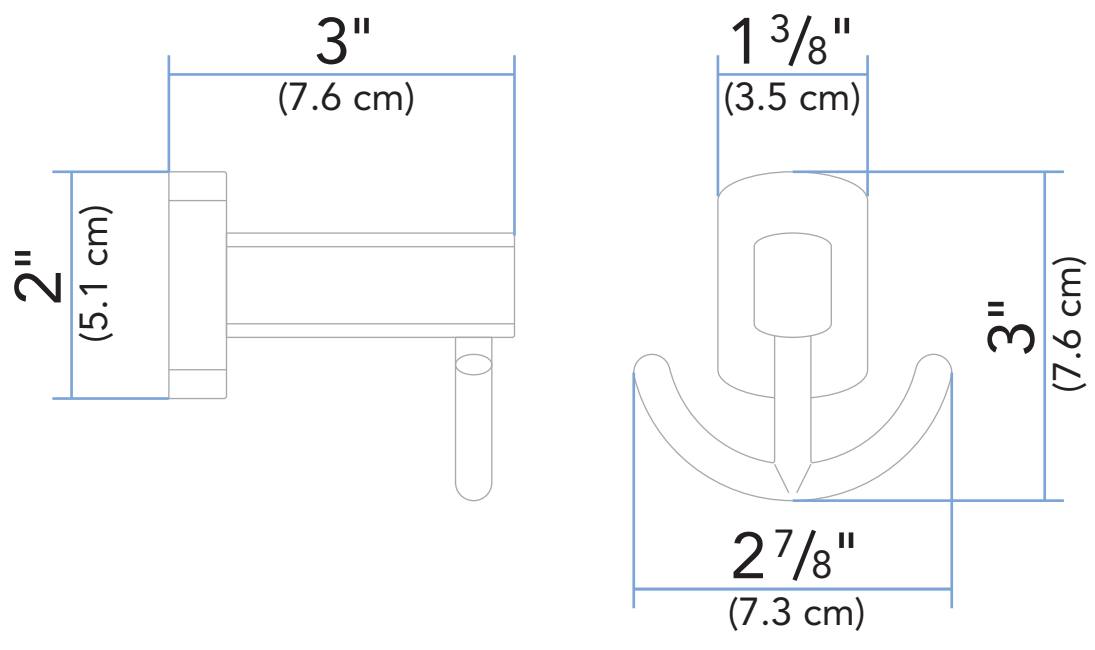

ALL DIMENSIONS ± 1/16"
SOME COMPONENTS MAY NOT BE DRAWN TO SCALE
Ambassador Marine Inc. reserves the right to make product specification changes and to change or discontinue models without notice or obligation