

Rev. Change

A	SHURflo branded
B	Ambassador branded
C	
D	
E	
F	
G	



www.ambassadormarine.com
(800) 270-4262

Model # **134-0230-xx**

Rev # **B**

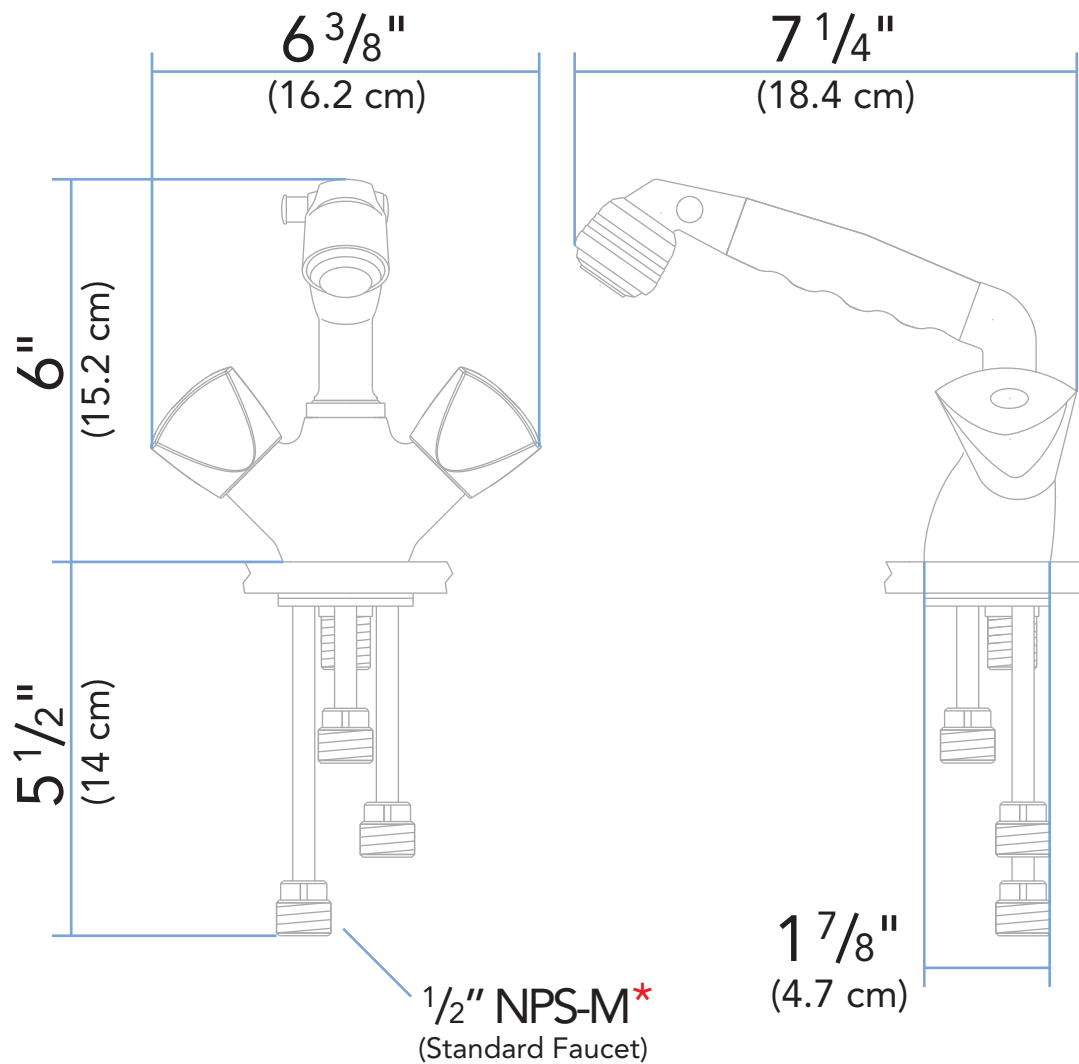

ALL DIMENSIONS ± 1/16"
SOME COMPONENTS MAY NOT BE DRAWN TO SCALE

Ambassador Marine Inc. reserves the right to make product specification changes and to change or discontinue models without notice or obligation

Installation Hole Requirement

This unit requires a minimum of this/these hole(s)

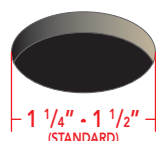

Your existing sink/countertop may have additional hole(s) pre-drilled, which may not be required for this installation.
If it does, you may be able to utilize a deck/cover plate or install an additional accessory (i.e. soap dispenser, purified water dispenser, hot water dispenser, etc.) to utilize the extra hole(s).
We offer a variety of deck/cover plates and soap dispensers to coordinate with your faucet and decor.

Supply Connection(s)

* Understanding **NPS vs. NPT**

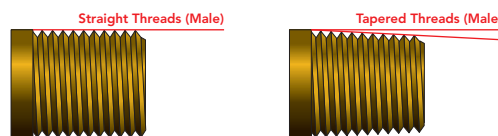

NPS = National Pipe Straight
NPT = National Pipe Tapered
(-M = Male -F = Female)

Plumbing fittings are commonly referred to as "NPT", however, in reality, nearly all faucets are actually "NPS". NPS is the North American "STANDARD" for faucets, regardless of brand, style, application, etc. Outside North America, BSP is the most commonly used standard.

Both NPS and NPT have the same thread angle, shape, and pitch (threads per inch). However, NPS threads are straight (parallel) and NPT threads are tapered (reduced).
Straight Pipe thread is commonly found on faucets, showerheads, hose connections and fittings. Tapered Pipe thread is commonly found on pipe ends, nipples and fittings (i.e. couplings, elbows, tees, etc.). Straight Pipe threads need a gasket or o-ring to create a seal. Both styles require sealant or plumber's tape for optimal seal. While NPS and NPT threads will engage, they do not seal properly with each other.