

**Rev. Change**

A	Ambassador branded
B	
C	
D	
E	
F	
G	



www.ambassadormarine.com  
(800) 270-4262

Model # **136-0243-xx**

Rev # **A**

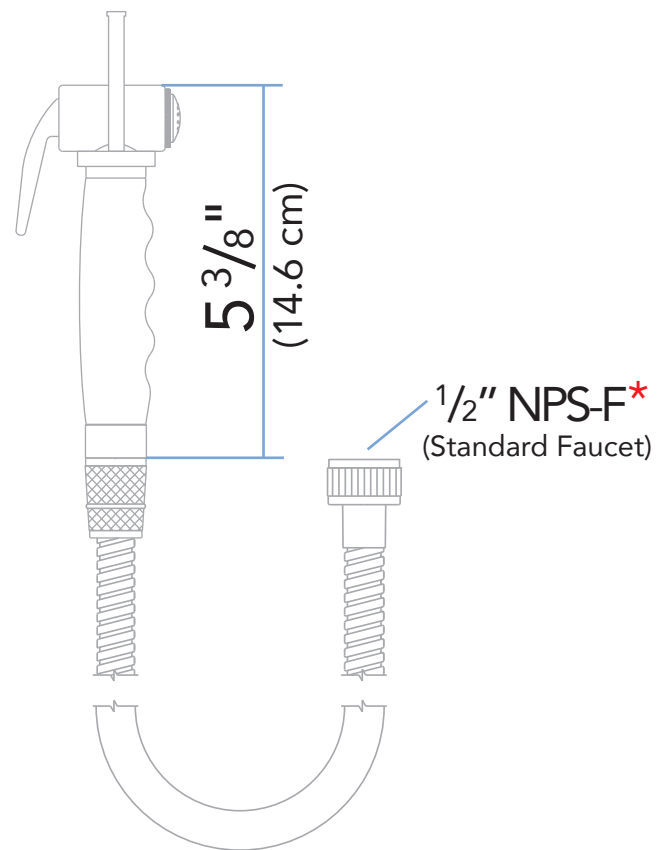
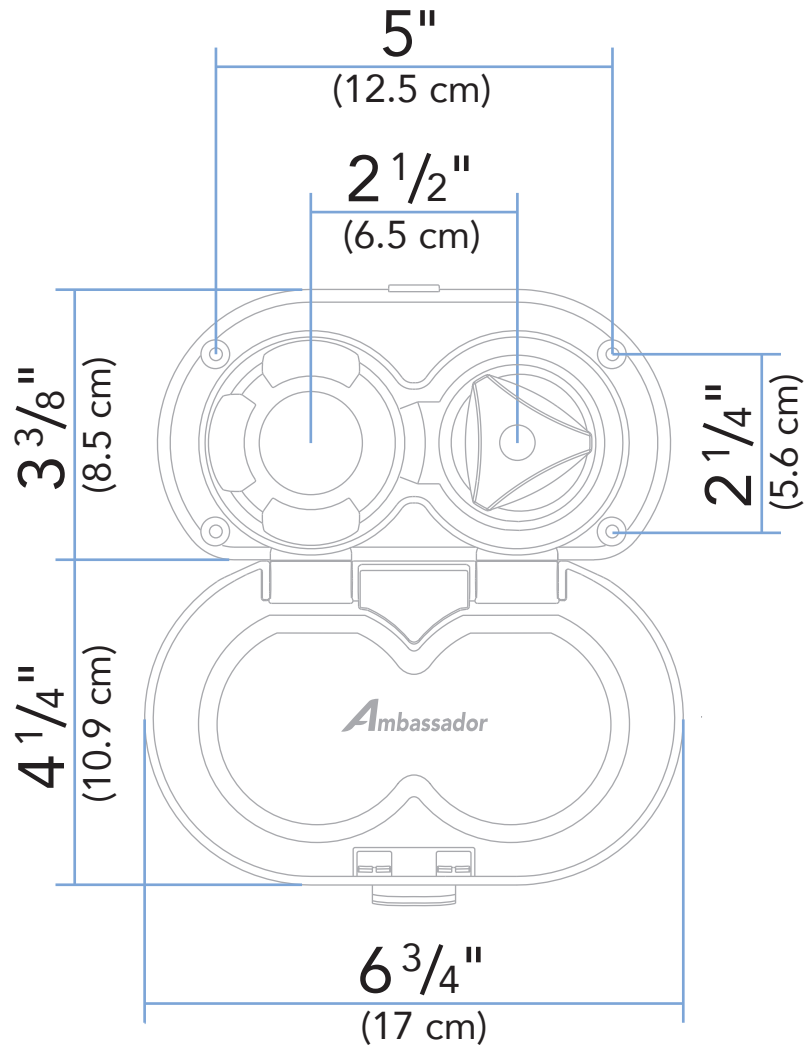
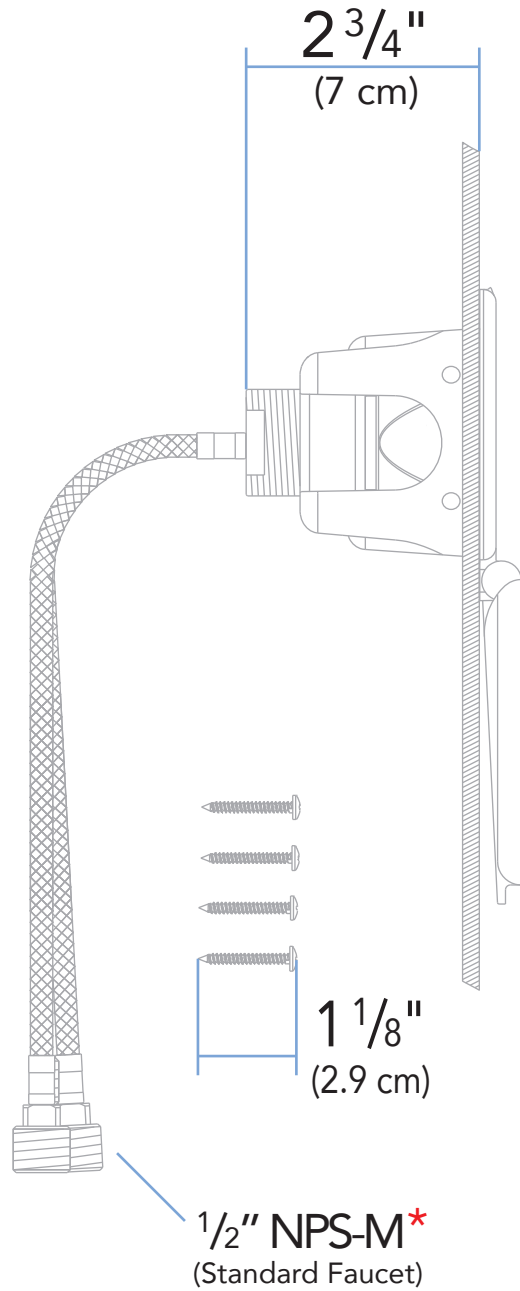

**Installation Hole Requirement**

This unit requires a **minimum** of this/these hole(s)

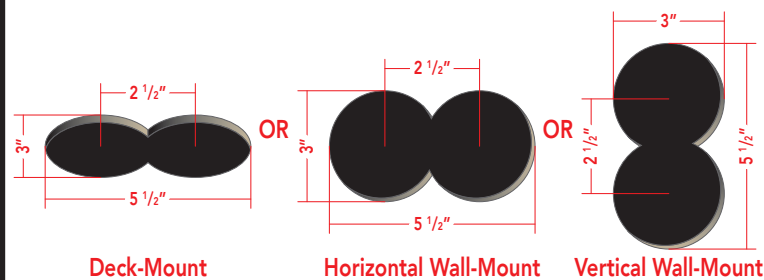

ALL DIMENSIONS ± 1/16"

SOME COMPONENTS MAY NOT BE DRAWN TO SCALE

Ambassador Marine Inc. reserves the right to make product specification changes and to change or discontinue models without notice or obligation