

Rev. Change

A	Original
B	
C	
D	
E	
F	
G	



www.ambassadormarine.com
(800) 270-4262

Model #
S00-1102-xx

Rev #
A

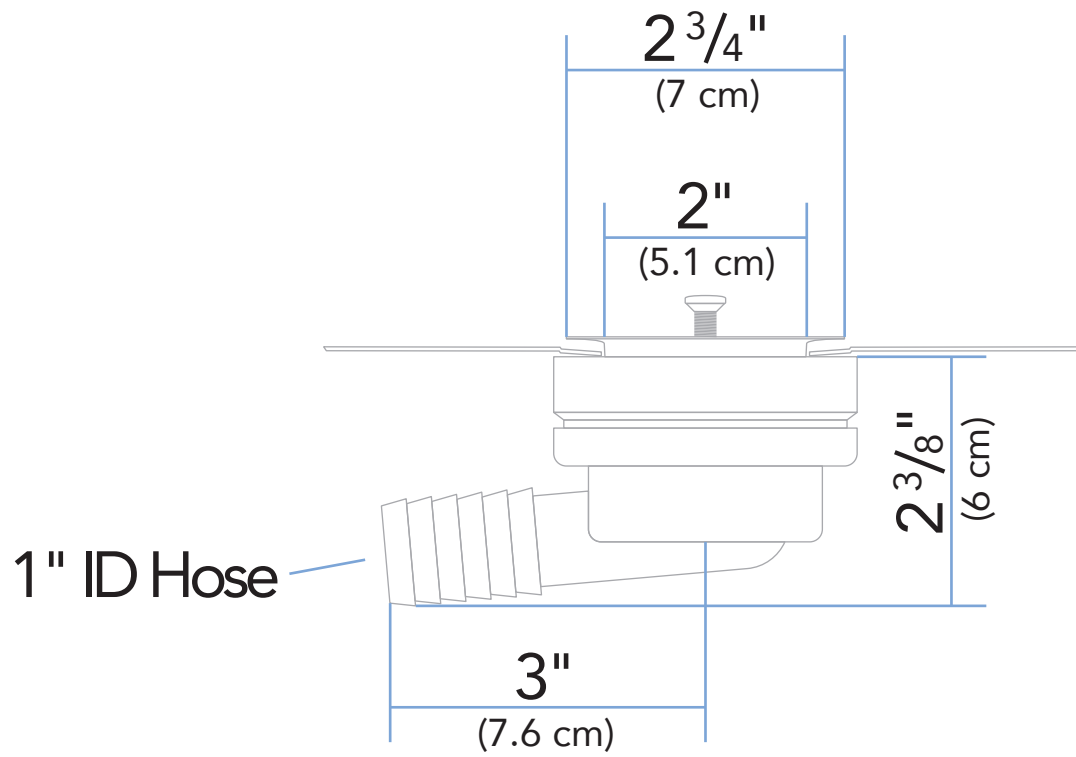

Drain Hole Requirement

This unit requires a *minimum* of this drain hole

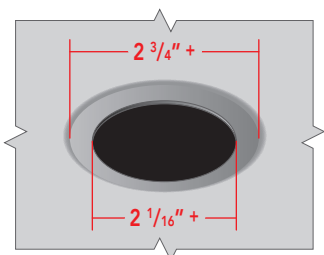

2" Drain

ALL DIMENSIONS ± 1/16"
SOME COMPONENTS MAY NOT BE DRAWN TO SCALE

Ambassador Marine Inc. reserves the right to make product specification changes and to change or discontinue models without notice or obligation