

Rev. Change

A	Original
B	Trap Body Threads
C	
D	
E	
F	
G	



www.ambassadormarine.com
(800) 270-4262

Model #

S01-0516-xx

Rev #

B

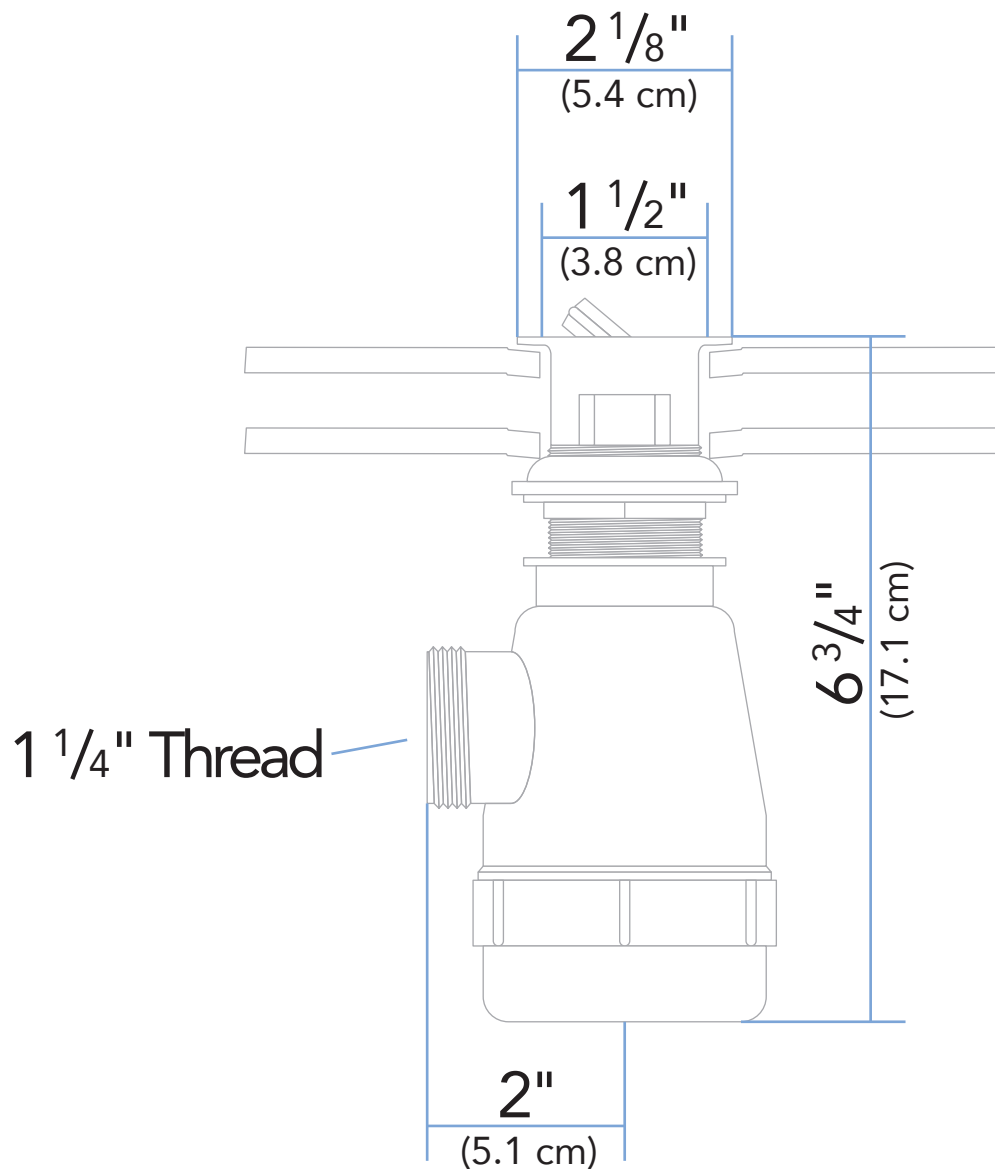

ALL DIMENSIONS ± 1/16"
SOME COMPONENTS MAY NOT BE DRAWN TO SCALE

Ambassador Marine Inc. reserves the right to make product specification changes and to change or discontinue models without notice or obligation

Drain Hole Requirement

This unit requires a **minimum** of this drain hole

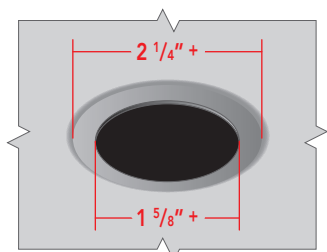

1 1/2" Drain

Fitting / Thread Size

* Understanding 1 1/4" Fittings / Threads

Although called a "1 1/4" Fitting" or "1 1/4" Thread", which is a standard plumbing pipe thread size in North America, the threads **DO NOT** actually measure 1 1/4", if measured with a ruler or tape measure. 1 1/4" is an internationally standardized term, not the true size of the fitting or threads.

"1 1/4 inch" FEMALE pipe fittings / threads actually measure **1.52 inches** from the crest (peak) of the threads on one side to the crest of threads on the opposite side

"1 1/4 inch" MALE pipe fittings / threads actually measure **1.62 inches** from the crest (peak) of the threads on one side to the crest of threads on the opposite side

