

Rev. Change

A	Original
B	Thailand
C	
D	
E	
F	
G	



www.ambassadormarine.com
(800) 270-4262

Model #

S64-1515-xx

Rev #

B

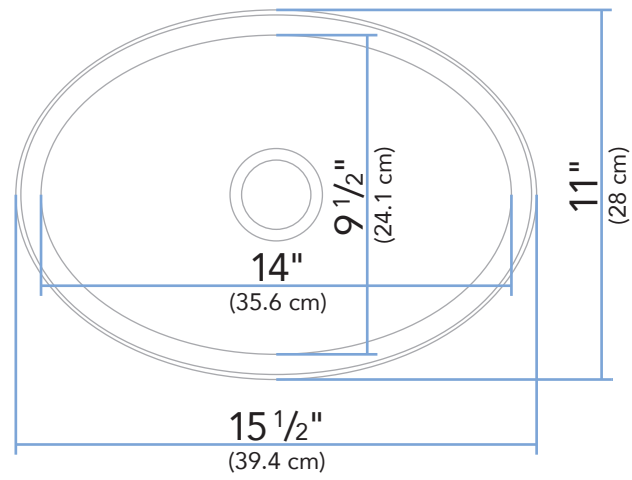

Drain Hole Requirement

This unit requires a **minimum** of this drain hole

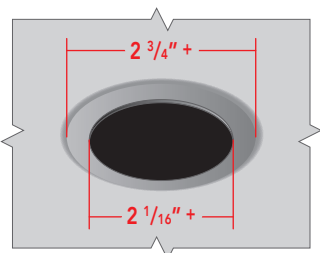

2" Drain

Flange (Rim) Style

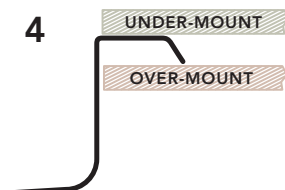

This Flange Style allows for either "Over-Mounting" or "Under-Mounting" of the sink on the counter-top

ALL DIMENSIONS ± 1/16"
SOME COMPONENTS MAY NOT BE DRAWN TO SCALE

Ambassador Marine Inc. reserves the right to make product specification changes and to change or discontinue models without notice or obligation